

GATES INDUSTRIAL FLUID POWER

CATALOG NO.	50080
EDITION	2024
SUPERSEDES	50080 (2013)

HYDRAULIC HOSE & COUPLINGS CATALOGUE

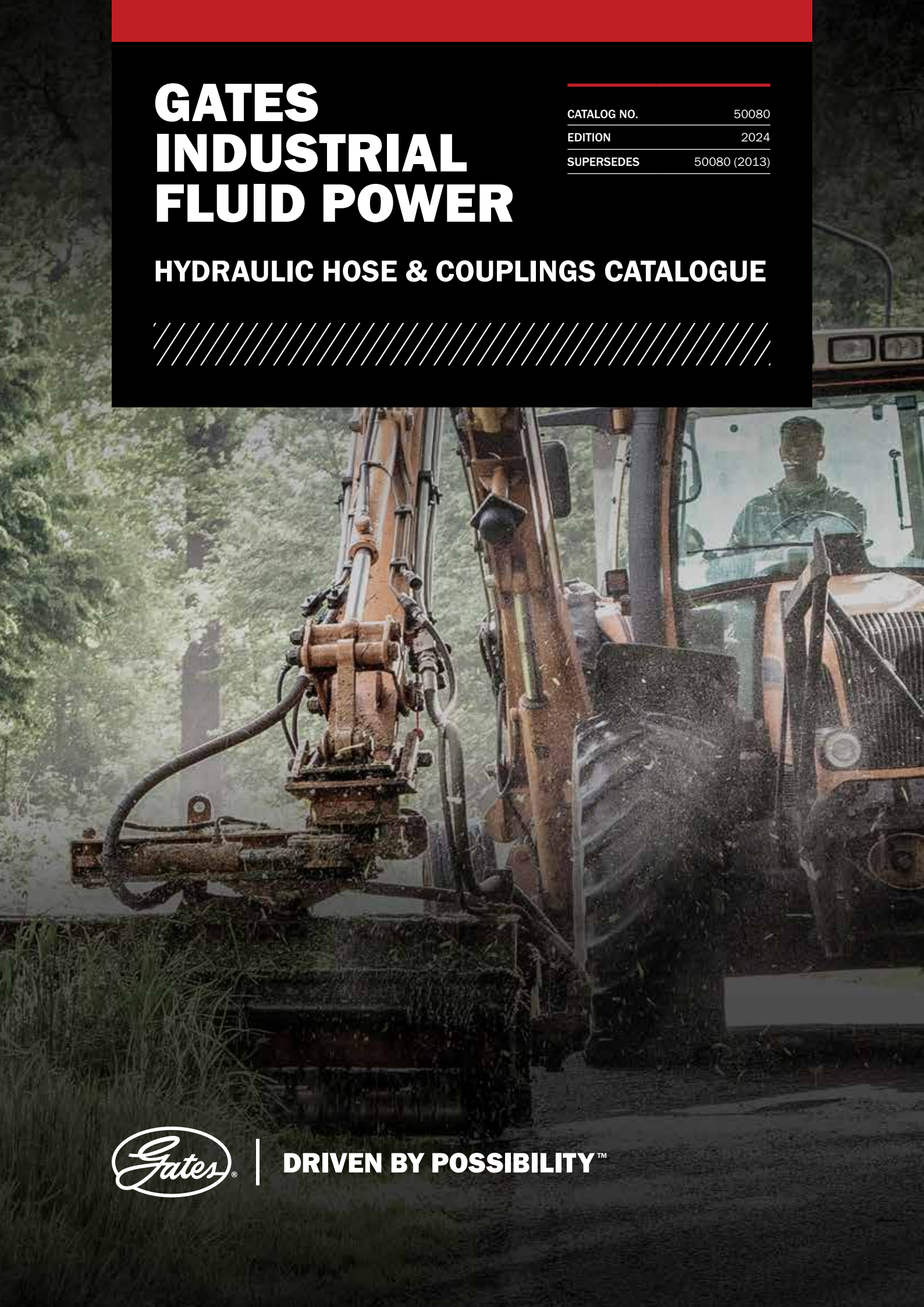

DRIVEN BY POSSIBILITY™



OUR VISION

**“CONTINUALLY PUSH
THE BOUNDARIES OF
MATERIALS SCIENCE TO
ADVANCE THE WAY THE
WORLD MOVES.”**

TABLE OF CONTENTS



EXPLANATION OF SYMBOLS AND NOMENCLATURE 10

ABOUT GATES

GATES INTEGRATED SYSTEM APPROACH 14

GATES MEGASYS 16

SAFETY AND SUSTAINABILITY 18

HYDRAULIC HOSE

HYDRAULIC HOSE SELECTION TABLE 22

MEGASYS

MEGASYS SPIRAL WIRE AND XPIRAL HYDRAULIC HOSE 25

TO EN / SAE / ISO STANDARD

EFG6K 26

EFG6K MEGATUFF COVER 27

EFG5K 28

EFG5K XTRATUFF COVER 29

EFG5K MEGATUFF COVER 30

MXG5K XTRATUFF PLUS COVER 31

EFG4K 32

EFG4K XTRATUFF COVER 33

EFG4K MEGATUFF COVER 34

MXG4K XTRATUFF PLUS COVER 35

EFG3K 36

EFG3K MEGATUFF COVER 37

SPECIAL LOW TEMP

EFG6KL 38

EFG5KL 39

EFG4KL 40

MEGASYS WIRE AND TEXTILE BRAID HYDRAULIC HOSE 41

TO EN / SAE / ISO STANDARD

M6K 42

M5K 43

M5K XTRATUFF COVER 44

M5K MEGATUFF COVER 45

M4K 46

M4K XTRATUFF COVER 47

M4K MEGATUFF COVER 48

M3K 49

M3K XTRATUFF COVER 50

M3K MEGATUFF COVER 51

M2T 52

M2T XTRATUFF COVER 53

M2T MEGATUFF COVER 54

MXT 55

MXT XTRATUFF PLUS COVER 56

CM2TDL XTRATUFF COVER 57

G2 58

G1 59

TH8 60

TH7 61

TH7DL 62

PILOT 63

SPECIAL HIGH / LOW TEMP

M4KH 64

M4KH MEGATUFF COVER 65

M4KL 66

M3KH 67

M3KH MEGATUFF COVER 68

G2XH 69

G2H 70

G2H MEGATUFF COVER 71

G2L 72

G1H 73

G3H 74

GTH 75

MULTI MASTER GMV 76

PRO SERIES

PRO SERIES HYDRAULIC HOSE 77

TO EN / SAE / ISO STANDARD

PROV 78

PRO1T 79

CR2 80

CR1 81

IA3K 82



HYDRAULIC HOSE COUPLINGS

COUPLING SELECTION TABLE 86

- MEGASYS COUPLINGS FOR SPIRAL WIRE AND XPIRAL HYDRAULIC HOSE 86
- MEGASYS COUPLINGS FOR WIRE AND TEXTILE BRAIDED HOSE 91
- MEGASYS COUPLINGS FOR PILOT HYDRAULIC HOSE..... 96
- PRO SERIES COUPLINGS FOR PRO SERIES HYDRAULIC HOSE 97
- ACCESSORIES..... 99

MEGASYS

MEGASYS COUPLINGS FOR SPIRAL WIRE AND XPIRAL HYDRAULIC HOSE

MEGASYS GLOBALSPIRAL MAXIMUM 102

- BSP FBSPORX 102
- BSP FBSPORX45 102
- BSP FBSPORX90 102
- BSP MBSPP 103
- JIC FJX 103
- JIC FJX45 103
- JIC FJX90 104
- JIC MJ 104
- SAE FFORX 104
- SAE FFORX45 105
- SAE FFORX90 105
- SAE FL 105
- SAE FL45 106
- SAE FL90 106
- SAE FLHCFM 106
- SAE FLHCFM45 107
- SAE FLHCFM90 107
- SAE FLH 107
- SAE FLH22 108
- SAE FLH30 108
- SAE FLH45 108
- SAE FLH60 109
- SAE FLH90 109
- FLC 109
- FLC22 110
- FLC30 110
- FLC45 110
- FLC90 111
- DIN 24° FDHORX 111
- DIN 24° FDHORX45 111

- DIN 24° FDHORX90 112
- NPTF MP 112
- PLSOR 112

MEGASYS GLOBALSPIRAL 113

- NO-SKIVE FERRULES FOR SPIRAL WIRE HOSE 113
- NO-SKIVE FERRULES FOR XPIRAL HOSE 113
- BSP FBSPORX 114
- BSP FBSPORX-RB 115
- BSP FBSPORX45 115
- BSP FBSPORX90 116
- BSP FBSPORX180 116
- BSP MBSPP 117
- BSP MBSPP-RB 117
- JIC 37° FJX 118
- JIC 37° FJX45 119
- JIC 37° FJX90S 119
- JIC 37° FJX90M 120
- JIC 37° FJX90L 120
- JIC 37° MJ 121
- JIS FKX 121
- SAE FFORX 122
- SAE FFORX45 123
- SAE FFORX90S 124
- SAE FFORX90M 125
- SAE FFORX90L 125
- SAE MFFOR 126
- SAE FL 126
- SAE FL22 127
- SAE FL30 127
- SAE FL45 128
- SAE FL60 128
- SAE FL67 129
- SAE FL90S 129
- SAE FL90M 130
- SAE FL90L 131
- SAE FLH 131
- SAE FLH22 132
- SAE FLH30 132
- SAE FLH45 133
- SAE FLH60 133
- SAE FLH67 134
- SAE FLH90S 134
- SAE FLH90M 135
- SAE FLH90L 135
- SAE FLH130 136

TABLE OF CONTENTS



FLK.....	136	BSP FBSPORX.....	158
FLK45.....	137	BSP FBSPORX45.....	158
FLK90.....	137	BSP FBSPORX90.....	159
FLC.....	138	BSP MBSPP.....	159
FLC22.....	138	JIC 37° FJX.....	159
FLC30.....	139	JIC 37° FJX45.....	160
FLC45.....	139	JIC 37° FJX90.....	160
FLC60.....	140	JIC 37° MJ.....	160
FLC67.....	140	SAE FFORX.....	161
FLC90.....	141	SAE FL.....	161
DIN 24° FDLORX.....	141	SAE FL22.....	161
DIN 24° FDLORX45.....	142	SAE FL30.....	162
DIN 24° FDLORX90.....	142	SAE FL45.....	162
DIN 24° MDL.....	143	SAE FL60.....	162
DIN 24° FDHORX.....	144	SAE FL90.....	163
DIN 24° FDHORX-RB.....	144	DIN 24° FDLORX.....	163
DIN 24° FDHORX45.....	145	DIN 24° FDLORX45.....	163
DIN 24° FDHORX90.....	145	DIN 24° FDLORX90.....	164
DIN 24° MDH.....	146	DIN 24° MDL.....	164
NPTF MP.....	146	DIN 24° FDHORX.....	164
UNF MB.....	147	DIN 24° FDHORX45.....	165
FG FFGX.....	147	DIN 24° FDHORX90.....	165
FG FFGX90.....	148	NPTF MP.....	165
FG MFG.....	148	MEGACRIMP..... 166	
FG FPFL.....	149	BSP MBSPT.....	166
FG MPFL.....	149	BSP FBSPORX.....	167
FG MPFL90.....	150	BSP FBSPORX45.....	168
KOBELCO MKB.....	150	BSP FBSPORX90.....	169
HLE.....	151	BSP FBSPORX90BL.....	170
HLE 90.....	151	BSP FBSPORX180.....	170
PL.....	152	BSP MBSPP.....	171
PLSOR.....	152	BSP MBSPPBKHD.....	172
MEGASYS COUPLINGS FOR		BSP FBFFX.....	172
WIRE AND TEXTILE BRAIDED HYDRAULIC HOSE		BSP MBFF.....	173
MEGASYS GLOBAL LOW..... 153		BSP BANJO.....	173
JIC 37° FJX.....	154	JIC 37° FJX.....	174
SAE FL.....	154	JIC 37° FJX45.....	175
SAE FL22.....	155	JIC 37° FJX90S.....	176
SAE FL30.....	155	JIC 37° FJX90M.....	177
SAE FL45.....	156	JIC 37° FJX90L.....	178
SAE FL60.....	156	JIC 37° MJ.....	179
SAE FL67.....	157	JIS FJISX.....	180
SAE FL90.....	157	JIS FXK.....	180
MEGASYS GLOBALSPIRAL PLUS..... 158		SAE FFORX.....	181
NO-SKIVE FERRULES.....	158		

TABLE OF CONTENTS
 ABOUT GATES
 HYDRAULIC HOSE
 HYDRAULIC HOSE COUPLINGS
 ENGINEERING AND TECHNICAL DATA

TABLE OF CONTENTS

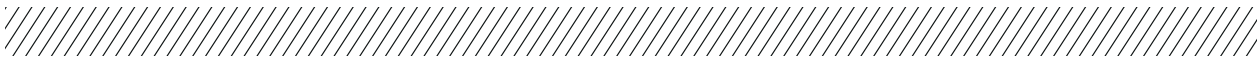

TABLE OF CONTENTS

ABOUT GATES

HYDRAULIC HOSE

HYDRAULIC HOSE COUPLINGS

ENGINEERING AND TECHNICAL DATA

SAE FFORX45S	182	UNF MB	212
SAE FFORX90S	183	UNF MBX.....	213
SAE FFORX90M.....	184	UNF MBX45BL	213
SAE FFORX90L.....	185	UNF MBX90	214
SAE MFFOR	186	UNF MBX90BL	214
SAE MFFORBKHD	186	FG FFGX	215
SAE 45° FSX.....	187	FG FFGX45.....	215
SAE 45° FSX45.....	188	FG FFGX90.....	216
SAE 45° FSX90.....	188	FG MFG	216
SAE 45° MS.....	189	HLE.....	217
SAE 45° MIX.....	189	PL.....	217
SAE 45° MIX45.....	190	AV.....	218
SAE 45° MIX90.....	190	PRESSUREWASH FPWXL.....	218
SAE 24° MFA	191	PRESSUREWASH PWSP.....	219
SAE FL	191	QUICK-LOK HIGH MQLH	219
SAE FL22	192	QUICK-LOK HIGH MQLH45.....	220
SAE FL30	192	QUICK-LOK HIGH MQLH90.....	220
SAE FL45	193	QUICK-LOK HIGH FQLH	221
SAE FL60	193		
SAE FL90	194	MEGASYS COUPLINGS FOR PILOT HYDRAULIC HOSE	
SAE FLH90.....	194	MEGASYS P1T	223
FLK	195	NO-SKIVE FERRULES.....	223
FLK45.....	195	BSP FBSPORX.....	223
FLK90.....	196	BSP FBSPORX45.....	223
DIN 24° FDLORX.....	197	BSP FBSPORX90.....	224
DIN 24° FDLORX45.....	198	JIC 37° FJX.....	224
DIN 24° FDLORX90.....	199	JIC 37° MJ	224
DIN 24° FDLORX180	200	SAE FFORX.....	225
DIN 24° MDL.....	200	SAE FFORX45.....	225
DIN 24° FDHORX	201	SAE FFORX90.....	225
DIN 24° FDHORX45.....	202	DIN 24° FDLORX.....	226
DIN 24° FDHORX90.....	203	DIN 24° FDLORX45.....	226
DIN 24° MDH	204	DIN 24° FDLORX90.....	226
DIN 24° MDH180	204	DIN 24° MDL	227
DIN 24° / 60° FDLX.....	205	METRIC DBJ	227
DIN 24° / 60° FDHX	205	QUIK-LOK DIRECT MQLD	227
METRIC MSP	206	QUIK-LOK DIRECT MQLD45.....	228
METRIC DBJ	207	QUIK-LOK DIRECT MQLD90.....	228
NPTF FPX.....	208	QLD RELEASE TOOL	228
NPTF MP	209	QUICK-LOK LOW MQLL.....	229
NPTF MPLN	210	QUICK-LOK LOW MQLL45	229
NPTF FP	210	QUICK-LOK LOW MQLL90	229
NPTF MPX	211	QLL RELEASE TOOL.....	230
NPTF MPX90	211		



PRO SERIES

PRO SERIES EX	232
NO-SKIVE FERRULES FOR PRO1T, CR2, CR1 & IA3K	232
NO-SKIVE FERRULES FOR PROV.....	232
BSP FBSPPX.....	233
BSP FBSPPX45	233
BSP FBSPPX90	234
BSP MBSPP	234
BSP BSPBJ.....	235
JIC 37° FJX.....	235
JIC 37° FJX45S	236
JIC 37° FJX90S	236
JIC 37° MJ	237
SAE FFORX.....	238
SAE FFORX45S	238
SAE FFORX90S	239
SAE MFFOR.....	239
DIN 24° FDLORX.....	240
DIN 24° FDLORX45.....	241
DIN 24° FDLORX90.....	242
DIN 24° MDL.....	243
DIN 24° FDHORX	244
DIN 24° FDHORX45	245
DIN 24° FDHORX90.....	246
DIN 24° MDH	247
METRIC MSP	247
METRIC DBJ	248
NPTF MP	248

ACCESSORIES

FLANGE KITS	250
SAE PA-FL FLANGE KIT.....	250
SAE PH-FLH FLANGE KIT	250
SAE PH-FLH MONOBLOC KIT	251
BANJO BOLTS & SEALS	252
BSP BONDED SEAL	252
DIN BONDED SEAL.....	252
BSP SINGLE HOLE BANJO BOLT.....	253
BSP DOUBLE HOLE BANJO BOLT	253
METRIC SINGLE HOLE BANJO BOLT	254
METRIC DOUBLE HOLE BANJO BOLT.....	254

ENGINEERING AND TECHNICAL DATA

CHEMICAL RESISTANCE TABLE	258
SELECTING THE CORRECT HOSE	287
HYDRAULIC HOSE ASSEMBLY AND INDUSTRIAL HOSE SELECTION CRITERIA.....	288
HOSE SIZE SELECTION NOMOGRAM	290
COUPLING SELECTION TABLE	291
MATERIAL TO BE CONVEYED	291
HYDRAULIC SYSTEM PRESSURE DROP	292
SELECTING THE CORRECT COUPLING	294
COUPLING SELECTION CRITERIA	295
COUPLING IDENTIFICATION.....	296
FEMALE COUPLINGS	
BSP FBSPORX.....	297
BSP FBFFX	297
JIC FJX.....	297
JIS FKX.....	297
SAE FFORX.....	297
SAE FSX.....	298
FDLORX / FDHORX	298
FG FFGX	298
DIN FDLX / FDHX	298
NPTF FPX.....	299
NPTF FP	299
MALE COUPLINGS	
BSP MBSPT.....	299
BSP MBSPP	299
BSP MBFF	299
JIC 37° MJ	299
SAE MFFOR.....	300
SAE 45° MS.....	300
SAE 45° MIX.....	300
SAE 24° MFA.....	300
DIN 24° MDL / MDH	300
NPTF MP	301
NPTF MPX	301
UNF MB	301
UNF MBX.....	301
FG MFG.....	301
KOBELCO MKB	301
BANJO COUPLINGS	
BSP BSPBJ.....	302
DIN DBJ	302

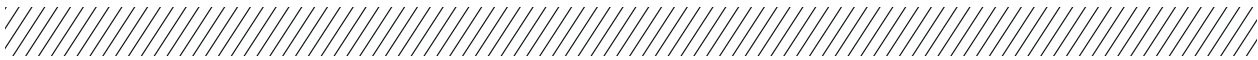

STANDPIPE COUPLINGS

METRIC MSP302

FLANGE COUPLINGS

SAE FL303

SAE FLH303

FLK303

FLC303

FG FPFL.....303

FG MPFL.....303

‘O’ RINGS

‘O’ RINGS304

IDENTIFICATION GUIDES

EASY IDENTIFICATION OF METRIC COUPLINGS.....305

THREAD SIZE IDENTIFICATION GUIDE306

COUPLING THREAD IDENTIFICATION.....310

HOSE ASSEMBLY SELECTION AND INSTALLATION..... 311

CALCULATING THE HOSE ASSEMBLY LENGTH312

HOSE ASSEMBLY ROUTING TIPS313

RECOMMENDED COUPLING INSTALLATION TORQUE IN NM

SAE 37° & 45°316

FLAT-FACED ‘O’ RING SEAL316

BSP 60° CONE316

DIN SERIES316

O-RING BOSS.....317

SAE FLANGES CODE 61.....317

NPTF PIPE317

SAE FLANGES CODE 62.....317

CONVERSION TABLES..... 318

HOW TO INTERPRET?

MPA TO PSI319

INCHES - MILLIMETRES319

METRIC (SI) - IMPERIAL UNITS

FOR HOSE AND CONNECTORS USE320

WARNING..... 321

WARNING.....322

LISTING OF GATES RESTRICTED APPLICATIONS.....324

DEFINITIONS326

GATES® ONE-STOP-SHOP FOR:

- **HYDRAULIC HOSES**
- **HOSE COUPLINGS**
- **HOSE ASSEMBLIES**
- **GUARDS AND SLEEVING**
- **ADAPTORS**
- **TUBE FITTING SYSTEMS**
- **SELF-ASSEMBLY MACHINERY**
- **OILFIELD PRODUCTS**
- **INDUSTRIAL HOSES**
- **ENGINEERING & SERVICES**
- **DIAGNOSTIC TOOLS**



FIND ALL AVAILABLE CATALOGUES ON [GATES.COM](https://www.gates.com)

EXPLANATION OF SYMBOLS AND NOMENCLATURE

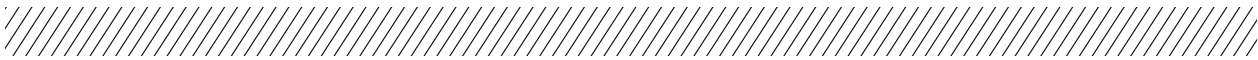

TABLE OF CONTENTS

ABOUT GATES

HYDRAULIC HOSE

HYDRAULIC HOSE COUPLINGS

ENGINEERING AND TECHNICAL DATA

HOSES - EXPLANATION OF SYMBOLS

Hose bore	Hose outside diameter	Maximum working pressure	Minimum burst pressure
Minimum bend radius	Vacuum	Weight	Hose

COUPLING - EXPLANATION OF SYMBOLS

Thread	SAE flange size	Banjo bolt size	Coupling

EXPLANATION OF COUPLING NOMENCLATURE

4	G	6	F	BSP	OR	X	45	BL
Hose inside diameter in 1/16 inches	GATES GLOBAL REFERENCE MegaCrimp™ Coupling	Thread size	Male / female	Type (e.g. BSP)	Soft seal 'O' ring	Swivel	Degree of bend (e.g. 45° or 90°)	Compact 90° block
				Termination type				



COUPLING - EXPLANATION OF TERMINATION NOMENCLATURE

Part number	Description
FBSPORX	Female BSP 'O' ring swivel
FBSPORX-RB	Female BSP 'O' ring swivel. 60° cone. Rockbreaker version.
FBSPPX	Female BSP swivel. 60° cone
MBSPP	Male BSP parallel. 60° inverted cone.
MBSPP-RB	Male BSP Parallel. 60° inverted cone. Rockbreaker version.
MBSPT	Male BSP Taper.
MBSPPBKHD	Male BSP parallel. 60° inverted cone (Bulkhead).
FBFFX	Female BSP flat face swivel.
MBFF	Male BSP flat face.
BSPBJ	BSP banjo.
FJX	Female JIC swivel. 37° inverted cone.
FJISX	Female Japanese swivel. 30° inverted cone. BSP thread.
FKX	Female Japanese swivel. 30° inverted cone. Metric thread.
MJ	Male JIC parallel. 37° cone.
FFORX	Female SAE flat face 'O' ring swivel.
MFFOR	Male SAE flat face 'O' ring.
MFFORBKHD	Male SAE flat face 'O' ring. Bulkhead.
FSX	Female SAE swivel. 45° inverted cone.
MS	Male SAE parallel. 45° cone.
MIX	Male SAE parallel. 45° inverted cone.
MFA	Male SAE parallel. 24° inverted cone.
FL	SAE 'O' ring flange. Code 61.
FLH	SAE 'O' ring flange high-pressure. Code 62.
FLHCFM	SAE 'O' ring flange with pre-installed monobloc.
FLC	Caterpillar type 'O' ring flange.
FLK	Komatsu type 'O' ring flange.
FDLORX	Female DIN 'O' ring swivel. 24° cone. Light series.
MDL	Male DIN parallel. 24° inverted cone. Light series.
FDHORX	Female DIN 'O' ring swivel. 24° cone. Heavy series.
FDHORX-RB	Female DIN 'O' ring swivel. 24° cone. Heavy series.
MDH	Male DIN parallel. 24° inverted cone. Heavy series.
FDLX	Female DIN swivel. 24°/60° cone. Light series.
FDHX	Female DIN swivel. 24°/60° cone. Heavy series.
DBJ	Metric banjo.
MSP	Metric standpipe.
FPX	Female NPSM pipe swivel. 30° cone.
MP	Male NPTF pipe.
MPLN	Male NPTF pipe (Long Nose).
MPX	Male NPTF pipe swivel.
MB	Male SAE 'O' ring boss.
MBX	Male SAE 'O' ring boss swivel.
FFGX	Female French Gaz swivel. 24° cone.
MFG	Male French Gaz parallel. 24° inverted cone.
FP	Female NPTF pipe.
FPFL	Female French Gaz flange high-pressure. 24° Poclairn inverted cone.
MPFL	Male French Gaz flange high-pressure. 24° Poclairn inverted cone.
MKB	Male Kobelco type.
HLE	Hose length extender
PL	Male Press-Lok.
PLSOR	Male Press-Lok Super 'O' ring.
AV	Male agricultural valve.
FPWXL	Female PressureWash swivel.
PWSP	Male PressureWash standpipe with 'O' ring.
MQLH	Male Quick-Lok™ High.
FQLH	Female Quick-Lok™ High.
MQLD	Male Quick-Lok™ Direct.
MQLL	Male Quick-Lok™ Low.





ABOUT GATES

GET WORKING BETTER WITH THE GATES® INTEGRATED SYSTEM APPROACH

TABLE OF CONTENTS

ABOUT GATES

HYDRAULIC HOSE

HYDRAULIC HOSE COUPLINGS

ENGINEERING AND TECHNICAL DATA



Based on the Gates Integrated System approach, our hose and coupling components make it extremely simple to create high-quality hydraulic hose assemblies quickly for the equipment you're using.

All Gates hydraulic products are specifically designed, tested and validated together to produce pre-tested and validated hose/coupling combinations that perform beyond any international standard.

This unique approach is how Gates ensures full compliance with the European Machinery Directive performance requirements and the reason why Gates is known as the world's most trusted hydraulic hose assembly manufacturer.

DID YOU KNOW:

- It's mandatory to mark hose assemblies, showing the manufacturing date and the assembler's name (2006/42/EC - ISO 4413:2010)
- The lifetime of hose assemblies is limited?
- A burst hydraulic hose under pressure can result in serious injuries or even death?
- The assembler can be held responsible for the consequences of a failed hydraulic hose assembly (2006/42/EC - ISO 4413:2010)?
- You cannot mix and match components of different sources that are not validated nor tested (2006/42/EC - ISO 4413:2010)?
- The repair of hose assemblies is forbidden by law (2006/42/EC - ISO 4413:2010)?

HOW DOES THE GATES INTEGRATED SYSTEM APPROACH WORK AND WHAT'S IN IT FOR YOU?



Superior products, manufactured to the stringent tolerances

Our global hoses and couplings are manufactured to rigorous tolerances, making sure that they perform to such a high standard they'll work safely for a longer time.

Benefit from less downtime.

Advanced self-assembly machines and dies, rigorously validated

Our self-assembly machines make it quick and easy for you to produce the hose and coupling combinations you need. Gates dies have a special proprietary profile design that creates an almost perfectly cylindrical and durable crimp. We test and validate them at our factory so you can be sure they'll work time after time in your workshop.

Increase the efficiency in your workshops.

Optimal crimp data, derived from meticulous testing

Each Gates crimper comes with validated crimp settings data for the complete global hose and coupling product range. So there's no need for time consuming trial-and-error to find the ideal settings! Gain fast and easy access to crimping instructions and crimp diameters via eCrimp. gates.eu or the eCrimp app.

Set crimpers with the greatest of ease.

Factory-quality performance above and beyond international standards

All this put together ensures the quality, performance and reliability that Gates is known for. When Gates hose and couplings are crimped in accordance with the Gates Integrated System, they yield factory-quality assemblies fully compliant to European Directives and legislation exceeding all international standards. Gates global wire-braid hose and MegaCrimp™ coupling assemblies are developed to withstand more than 3 times international standards. Gates spiral wire hose and GlobalSpiral coupling assemblies will work beyond a million impulse cycles.

Trust Gates' exceptional performance and reliability.

DELIVERING IMPROVED SAFETY, RELIABILITY AND PRODUCTIVITY THROUGH THE GATES INTEGRATED SYSTEM APPROACH

EXCELLENCE, INNOVATION AND RELIABILITY BUILT IN

Whether you need components or complete assemblies, the Gates option gives you a wide range of important benefits:



TABLE OF CONTENTS

ABOUT GATES

HYDRAULIC HOSE

HYDRAULIC HOSE COUPLINGS

ENGINEERING AND TECHNICAL DATA



LONG-LASTING HOSES – THE BEST CHOICE FOR TOUGH CONDITIONS

Gates global hoses are designed for the harshest fluids and most abrasive environments. On the inside, the full nitrile inner tube resists even the most aggressive oils. On the outside, the tough standard hose covers give you unparalleled abrasion resistance. For the harshest conditions our XtraTuff™, XtraTuff™ Plus or MegaTuff™ covers to give you exceptional resistance to abrasion and ozone.

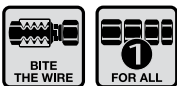

MEGACRIMP & GLOBALSPIRAL COUPLINGS TWO FAMILIES. COMPLETE COVERAGE

MegaCrimp™ is a one-piece coupling that offers a weep free C-insert design, full insertion indication, low insertion force, and doesn't require skiving. The Gates MegaCrimp couplings and wire/textile-braid hoses are designed so that one ferrule fits the entire range for each respective construction.

GlobalSpiral™ couplings are specially engineered to provide superior performance for extreme high-pressure, high-impulse spiral-wire hydraulic hose applications.



SELECTION AND ASSEMBLY MADE EASY

The hose-coupling interface is key to high performance of assemblies and safe hydraulics. From selecting the parts to the final crimp O.D., and everything in between, the interface is essential to keep equipment running and workers safe. All our hoses and couplings are designed together – each with the other in mind. They carry logical part numbers to make identification simple and fast.

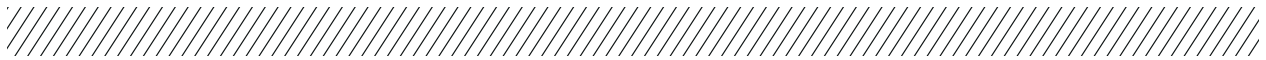

EASIER ROUTING WITH MORE COMPACT ASSEMBLIES

Gates global hoses are the ideal choice for tight, tortuous applications as they're designed to deliver their superior performance at incredibly tight bend radii and are manufactured to need minimal bending force.



HIGH- AND LOW-TEMPERATURE HOSES – DURABILITY AND FLEXIBILITY EVEN AT EXTREME TEMPERATURES

The Gates PolarFlex™ programme uses advanced compounding technology for its hose tube and cover to bring the advantages of the MEGASys™ hose ranges to arctic environments, thus ensuring extended service life, high abrasion resistance and flexibility at extremely low temperatures.

To meet the demands of modern compact engines Gates has developed a range of hoses for extremely low or high-temperature environments, without compromising flexibility, performance or service life.



CLEANER, LEAK-FREE ASSEMBLIES THAT LAST LONGER

All of our hydraulic hose/coupling solutions are no-skive, so your assemblies don't risk contamination you can get with their skived counterparts. Additional benefits to no-skive assemblies are that they resist moisture better than skived ones and that easy assembly saves you time and money.

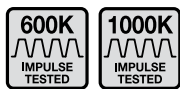

QUALITY ABOVE AND BEYOND ANY GLOBAL STANDARD

Gates global wire-braid hose and MegaCrimp coupling assemblies are able to withstand impulse testing to more than 3 times international standards. Gates global spiral wire hose and GlobalSpiral coupling assemblies will work safely beyond a million cycles. All of this means you get reliability built in as standard.



GATES SOLUTIONS KEEP YOU RUNNING SMOOTHLY

EVOLVE WITH GATES

Our world is evolving. Increased demands for health and safety, along with changing legislation and the rising cost of energy means it's time to upgrade hydraulic systems. We have adopted a strong commitment to sustainability to help our customers face these challenges, delivering durable solutions through our products.

GATES SAFE HYDRAULICS: THINK SAFETY!

In Europe the main safety Directive covering hose and machinery products is the European Machinery Directive 2006/42/EC. This provides the regulatory basis for the harmonisation of essential health and safety requirements for machinery at European Union level.

The Gates Integrated System of hoses, couplings, self-assembly machines and crimp data – used together – ensure you fully comply with this European Machinery Directive.

Your safety and that of your workforce, your customer and the environment is always a top priority for us. That's why we offer our customers guidance on a safety and preventive maintenance via our Safe Hydraulics Programme.

The programme is designed by Gates application engineers and focuses on following topics:

- How to work safely and how to reduce your risks and protect the environment
- The entire safety process: storage, selection, installation and inspection
- How to avoid material and personal hazards and liability issues
- Expert information on safety issues affecting hydraulic hose assemblies

You can contact your local Gates representative to find out more.

PROTECTING HEALTH & ENVIRONMENT - A GATES COMMITMENT TO OUR CUSTOMERS

Gates strives to protect the environment in a variety of ways:

- We encourage the use of alternative lubricants like synthetic and biodegradable oils with our hoses specially designed with nitrile inner tubes
- Gates' unique, self-lubricating and grease-free self-assembly machinery help create a clean working environment resulting in reduced downtime, lower maintenance costs and an overall lower cost of ownership.
- We help eliminate the risk of system contamination no-skive hose/coupling solutions
- Leak-free assemblies exclude environmental contamination
- Gates Corporation is committed to conducting our business with care for the health, safety, and wellness of our customers and of the communities where we operate. As part of that commitment, we comply with all applicable laws and regulations in the jurisdictions where we market our products. All the publicly available Gates sustainability policies are accessible on the company website under the policies section: <https://www.gates.com/gb/en/knowledge-centre/media-library/policies-and-statements.html>









HYDRAULIC HOSE

HYDRAULIC HOSE SELECTION TABLE



TABLE OF CONTENTS
ABOUT GATES
HYDRAULIC HOSE
HYDRAULIC HOSE COUPLINGS
ENGINEERING AND TECHNICAL DATA

		Construction			Temperature °C	Size & Working pressure (MPa)															
		Tube ⁽¹⁾	Reinforcement	Cover ⁽¹⁾		-3	-4	-5	-6	-8	-10	-12	-16	-20	-24	-32					
					5 mm	6 mm	8 mm	10 mm	13 mm	16 mm	19 mm	25 mm	32 mm	38 mm	51 mm						
MEGASYS	MEGASYS SPIRAL WIRE AND SPIRAL HOSES	TO EN / SAE / ISO STANDARD	EFG6K	NBR	4 SW & 6 SW	CR	-40/121				42.0	42.0	42.0	42.0	42.0	42.0	42.0	42.0	42.0	42.0	
			EFG6K-MTF	NBR	4 SW & 6 SW	CR	-40/121				42.0	42.0	42.0	42.0	42.0	42.0	42.0	42.0	42.0	42.0	42.0
			EFG5K	NBR	4 SW & 6 SW	CR	-40/121				35.0	35.0	35.0	35.0	35.0	35.0	35.0	35.0	35.0	35.0	35.0
			EFG5K-XTF	NBR	4 SW & 6 SW	CR	-40/121				35.0	35.0	35.0	35.0	35.0	35.0	35.0	35.0	35.0	35.0	35.0
			EFG5K-MTF	NBR	4 SW & 6 SW	CR	-40/121				35.0	35.0	35.0	35.0	35.0	35.0	35.0	35.0	35.0	35.0	35.0
			MXG5K-XTP	NBR	4 XP	CR	-40/121				35.0	35.0	35.0	35.0	35.0	35.0	35.0	35.0	35.0	35.0	35.0
			EFG4K	NBR	4 SW	CR	-40/121				28.0	28.0	28.0	28.0	28.0	28.0	28.0	28.0	28.0	28.0	28.0
			EFG4K-XTF	NBR	4 SW	CR	-40/121				28.0	28.0	28.0	28.0	28.0	28.0	28.0	28.0	28.0	28.0	28.0
			EFG4K-MTF	NBR	4 SW	CR	-40/121				28.0	28.0	28.0	28.0	28.0	28.0	28.0	28.0	28.0	28.0	28.0
			MXG4K-XTP	NBR	4 XP	CR	-40/121				28.0	28.0	28.0	28.0	28.0	28.0	28.0	28.0	28.0	28.0	28.0
	EFG3K	NBR	4 SW	CR	-40/121												21.0	21.0	21.0		
	EFG3K-MTF	NBR	4 SW	CR	-40/121												21.0	21.0	21.0		
	EFG6KL	NBR	4 SW	CR	-57/100					42.0	42.0	42.0	42.0	42.0	42.0	42.0	42.0	42.0	42.0		
	EFG5KL	NBR	4 SW	CR	-57/100					35.0	35.0	35.0	35.0	35.0	35.0	35.0	35.0	35.0	35.0		
	EFG4KL	NBR	4 SW	CR	-57/100					28.0	28.0	28.0	28.0	28.0	28.0	28.0	28.0	28.0	28.0		
	MEGASYS WIRE AND TEXTILE BRAID HOSES	TO EN / SAE / ISO STANDARD	M6K	NBR	2 WB	NBR/PVC	-40/100		42.0												
			M5K	NBR	2 WB	NBR/PVC	-40/100		35.0	35.0	35.0	35.0									
			M5K-XTF	NBR	2 WB	NBR/PVC	-40/100		35.0			35.0	35.0								
			M5K-MTF	NBR	2 WB	NBR/PVC	-40/100		35.0			35.0	35.0								
			M4K	NBR	2 WB	NBR/PVC	-40/100		28.0	28.0	28.0	28.0	28.0	28.0							
M4K-XTF			NBR	2 WB	NBR/PVC	-40/100		28.0	28.0	28.0	28.0	28.0	28.0								
M4K-MTF			NBR	2 WB	NBR/PVC	-40/100		28.0	28.0	28.0	28.0	28.0	28.0								
M3K			NBR	1WB & 2 WB	NBR/PVC	-40/100		22.5	22.5	22.5	22.5	22.5	22.5	22.5							
M3K-XTF			NBR	1WB & 2 WB	NBR/PVC	-40/100		22.5	22.5	22.5	22.5	22.5	22.5	22.5							
M3K-MTF			NBR	1WB & 2 WB	NBR/PVC	-40/100		22.5	22.5	22.5	22.5	22.5	22.5	22.5							
M2T		NBR	2 WB	NBR/PVC	-40/100		42.0	38.0	35.0	29.6	26.2	24.1	17.2	15.9	14.0	10.3					
M2T-XTF		NBR	2 WB	NBR/PVC	-40/100		42.0	38.0	35.0	29.6	26.2	24.1	17.2	15.9	14.0	10.3					
M2T-MTF		NBR	2 WB	NBR/PVC	-40/100		42.0	38.0	35.0	29.6	26.2	24.1	17.2	15.9	14.0	10.3					
MXT		NBR	WB	NBR/PVC	-40/100		42.0	38.0	33.0	28.0	25.0	21.5	16.5								
MXT-XTP		NBR	WB	NBR/PVC	-40/100		42.0	38.0	33.0	28.0	25.0	21.5	16.5								
CM2TDL-XTF		NBR	2 WB	NBR	-40/100					33.0	27.5										
G2		NBR	2 WB	NBR/PVC	-40/100		40.0	35.0	33.0	27.5	25.0	21.5	16.5	12.5	9.0	8.0					
G1		NBR	1 WB	NBR/PVC	-40/100		22.5	21.5	18.0	16.0	13.0	10.5	9.0	6.4	5.0	4.2					
TH8		PA	2 FB	PU	-53/93		35.0			28.0	24.5	15.8	14.0								
TH7		PA	1 FB + 2 YS	PU	-53/93		19.2	17.5	15.8	14.0			8.7	7.0							
TH7DL	PA	1 FB + 2 YS	PU	-53/93		19.2	17.5	15.8	14.0												
PILOT	NBR	1 WB	NBR/PVC	-40/100		12.0	12.0	12.0	12.0												
SPECIAL HIGH/LOW TEMP	M4KH	NBR	2 WB	CR	-40/121		28.0		28.0	28.0	28.0	28.0									
	M4KH-MTF	NBR	2 WB	CR	-40/121		28.0		28.0	28.0	28.0	28.0									
	M4KL	NBR	2 WB	NBR/PVC	-57/100		28.0	28.0	28.0	28.0	28.0	28.0									
	M3KH	NBR	1WB & 2 WB	CR	-40/121		22.5	22.5	22.5	22.5	22.5	22.5	22.5								
	M3KH-MTF	NBR	1WB & 2 WB	CR	-40/121		22.5	22.5	22.5	22.5	22.5	22.5	22.5								
	G2XH	CPE	2 WB	CSM	-40/150		42.0			35.0	29.0	25.0	21.5	17.5	15.5	12.4	10.3				
	G2H	NBR	2 WB	CSM	-40/135										12.5	9.0	8.0				
	G2H-MTF	NBR	2 WB	CSM	-40/135										12.5	9.0	8.0				
	G2L	NBR	2 WB	CR	-57/100		40.0		33.0	27.5	25.0	21.5	16.5	12.5	9.0	8.0					
	G1H	NBR	1 WB	CSM	-40/135		19.0		15.5	13.8	10.3	8.6	6.9	6.4	5.0	4.2					
G3H	NBR	2 FB	CR	-40/135		8.8		7.9	7.0	6.2	5.2	3.9	2.6								
GTH	NBR	1 FB	CR	-40/135		2.8	2.8	2.8	2.8	2.4	2.1	1.7									
PRO SERIES	MULTI MASTER™ GMV™	NBR	TEXTILE	CR	-40/135								2.4	2.1	1.7	1.0	1.0				
	PROV	NBR	WB	NBR/PVC	-40/100		40.0	35.0	33.0	27.5	25.0	21.5	16.5								
	PRO1T	NBR	1WB	SBR	-40/100		22.5	21.5	18.0	16.0	13.0	10.5	8.8								
	CR2	NBR	2WB	SBR	-40/100		40.0	34.0	33.0	27.5	25.0	21.5	16.5								
	CR1	NBR	1WB	SBR	-40/100		22.5	21.5	18.0	16.0	13.0	10.5	8.8								
IA3K	NBR	1WB	NBR/PVC	-40/100		21.0	21.0	21.0	21.0	21.0	21.0	21.0									

(1) Indicates main component of compound

Abbreviations	
FB	Fibre Braid
SW	Spiral Wire
WB	Wire Braid
XP	Xpiral
YS	Yam Spiral

Abbreviation	Standard
ABS	American Bureau of Shipping
BV	Bureau Veritas
DNV	Det Norske Veritas (North Sea Floating Vessels)
LR	Lloyd's Register
MSHA	Mine Safety and Health Administration

HYDRAULIC HOSE SELECTION TABLE



		International standards			Marine type approvals				MSHA	
		EN	SAE	ISO	DNV	LR	BV	ABS		
MEGASYS SPIRAL WIRE AND SPIRAL HOSES	TO EN / SAE / ISO STANDARD	EFG6K		SAE 100R15	ISO 3862 R15	✓	✓	✓	✓	✓
		EFG6K-MTF		SAE 100R15	ISO 3862 R15	✓				✓
		EFG5K	EN 856 R13	SAE 100R13	ISO 3862 R13	✓	✓	✓	✓	✓
		EFG5K-XTF	EN 856 R13	SAE 100R13	ISO 3862 R13	✓				✓
		EFG5K-MTF	EN 856 R13	SAE 100R13	ISO 3862 R13	✓				✓
		MXG5K-XTP			ISO 18752 350DC	✓	✓	✓	✓	✓
		EFG4K	EN 856 R12	SAE 100R12	ISO 3862 R12	✓	✓	✓	✓	✓
		EFG4K-XTF	EN 856 R12	SAE 100R12	ISO 3862 R12	✓				✓
		EFG4K-MTF	EN 856 R12	SAE 100R12	ISO 3862 R12	✓				✓
		MXG4K-XTP		SAE 100R19	ISO 18752 280DC	✓	✓	✓	✓	✓
		EFG3K	EN 856 R12	SAE 100R12	ISO 3862 R12	✓	✓	✓	✓	✓
		EFG3K-MTF	EN 856 R12	SAE 100R12	ISO 3862 R12	✓				✓
		EFG6KL		SAE 100R15	ISO 3862 R15					✓
	EFG5KL		SAE 100R13	ISO 3862 R13					✓	
EFG4KL		SAE 100R12	ISO 3862 R12					✓		
MEGASYS WIRE-AND TEXTILE BRAID HOSES	TO EN / SAE / ISO STANDARD	M6K				✓	✓	✓		✓
		M5K				✓	✓	✓		✓
		M5K-XTF				✓				✓
		M5K-MTF				✓				✓
		M4K		SAE 100R19	ISO 11237 R19	✓	✓	✓	✓	✓
		M4K-XTF		SAE 100R19	ISO 11237 R19	✓				✓
		M4K-MTF		SAE 100R19	ISO 11237 R19	✓				✓
		M3K		SAE 100R17	ISO 11237 R17	✓	✓	✓	✓	✓
		M3K-XTF		SAE 100R17	ISO 11237 R17	✓				✓
		M3K-MTF		SAE 100R17	ISO 11237 R17	✓				✓
		M2T		SAE 100R16	ISO 11237 R16	✓	✓	✓	✓	✓
		M2T-XTF		SAE 100R16	ISO 11237 R16	✓				✓
		M2T-MTF		SAE 100R16	ISO 11237 R16	✓				✓
		MXT		SAE 100R16	ISO 11237 R16	✓	✓	✓	✓	✓
		MXT-XTP		SAE 100R16	ISO 11237 R16					✓
		CM2TDL-XTF	EN 857 2SC	SAE 100R16	ISO 11237 2SC R16S					✓
		G2	EN 853 2SN	SAE 100R2AT	ISO 1436 2SN R2ATS	✓	✓	✓	✓	✓
		G1	EN 853 1SN	SAE 100R1AT	ISO 1436 1SN R1ATS	✓	✓	✓	✓	✓
	TH8	EN 855 R8	SAE 100R8	ISO 3949 R8						
	TH7	EN 855 R7	SAE 100R7	ISO 3949 R7						
	TH7DL	EN 855 R7	SAE 100R7	ISO 3949 R7						
	PILOT								✓	
	M4KH		SAE 100R19	ISO 11237 R19					✓	
	M4KH-MTF		SAE 100R19	ISO 11237 R19					✓	
	M4KL		SAE 100R19	ISO 11237 R19					✓	
	M3KH		SAE 100R17	ISO 11237 R17					✓	
	M3KH-MTF		SAE 100R17	ISO 11237 R17					✓	
	G2XH	EN 853 2SN	SAE 100R2AT	ISO 1436 2SN R2ATS					✓	
	G2H	EN 853 2SN	SAE 100R2AT	ISO 1436 2SN R2ATS					✓	
	G2H-MTF	EN 853 2SN	SAE 100R2AT	ISO 1436 2SN R2ATS					✓	
G2L	EN 853 2SN	SAE 100R2AT	ISO 1436 2SN R2ATS					✓		
G1H		SAE 100R1						✓		
G3H	EN 854 R3	SAE 100R3	ISO 4079 R3							
GTH	EN 854 R6	SAE 100R6 (-4 to -12)	ISO 4079 R6							
MULTI MASTER™ GMV™		SAE 100R4						✓		
PROV	EN 857 2SC	SAE 100 R16						✓		
PRO1T	EN 857 1SC / EN 853 2SN							✓		
CR2	EN 853 1SN							✓		
CR1								✓		
IA3K		SAE 100 R17						✓		

TABLE OF CONTENTS

ABOUT GATES

HYDRAULIC HOSE

HYDRAULIC HOSE COUPLINGS

ENGINEERING AND TECHNICAL DATA



MEGASYS™

Gates MEGASys hydraulic hose and coupling products offer an integrated solution to combination of technology and performance. The fully integrated MEGASys hose line is designed to provide maximum flexibility and high-quality in a wide range of high-pressure hydraulic applications while simplifying hose selection and assembly fabrication.



**MEGASYS™ SPIRAL WIRE AND
XPIRAL™ HYDRAULIC HOSE**



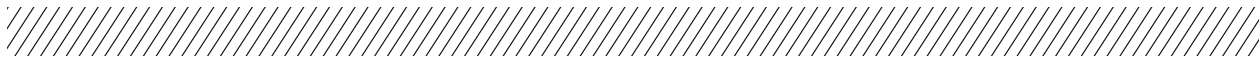

EFG6K

CONSTANT PRESSURE



-size	↻		⊘		⊙		🌸		⤵	⚖	📏
	DN	"	"	mm	PSI	MPa	PSI	MPa	mm	kg/100m	REF.
-6	10	3/8	0.80	20.2	6000	42.0	24000	168.0	65	71	6EFG6K
-8	12	1/2	0.95	24.0	6000	42.0	24000	168.0	90	89	8EFG6K
-10	16	5/8	1.09	27.6	6000	42.0	24000	168.0	100	115	10EFG6K
-12	19	3/4	1.24	31.4	6000	42.0	24000	168.0	120	144	12EFG6K
-16	25	1	1.53	38.7	6000	42.0	24000	168.0	150	223	16EFG6K
-20	31	1.1/4	1.97	50.0	6000	42.0	24000	168.0	210	399	20EFG6K
-24	38	1.1/2	2.26	57.4	6000	42.0	24000	168.0	250	482	24EFG6K
-32	51	2	2.80	71.1	6000	42.0	24000	168.0	635	719	32EFG6K

- RECOMMENDED FOR** Extremely high pressure and high impulse hydraulic applications.
- TUBE** NBR (Nitrile) based.
- REINFORCEMENT** Four (six for -20 to -32) alternating layers of spiralled, high tensile steel wire.
- COVER** CR (Chloroprene) based. MSHA approved.
- TEMPERATURE RANGE** -40°C to +121°C. For water emulsions, etc. see Engineering and technical data page 292.
- STANDARDS** Exceeds ISO 3862 R15. SAE 100R15.
Meets or exceeds performance requirements of EN 856 4SP (-8 to -32) and EN 856 4SH (-12 to -32).
- COUPLINGS** -6 to -20: GlobalSpiral; -24, -32: GlobalSpiral Maximum.
- TYPE APPROVALS** DNV, LR, BV and ABS.
- CHARACTERISTICS/BENEFITS**
- Up to 40% of EN 856 4SP/4SH bend radius at rated working pressure.
 - Extremely flexible.
 - Superior flex impulse performance: tested to 1,000,000 impulse cycles at 50% of SAE 100R15 bend radii (except -32).
 - EFG6K hose is compatible with biodegradable hydraulic fluids like synthetic esters, polyglycols and vegetable oils as well as petroleum-based fluids.
- OPTIONAL**
-  EFG6KL: for low-temperature applications, Gates recommends the EFG6KL range down to -57°C constant.

MEGASYS™ SPIRAL WIRE AND XPIRAL™ HYDRAULIC HOSE



EFG6K MEGATUFF™ COVER

CONSTANT PRESSURE



-size									mm	kg/100m	REF.
	DN	"	"	mm	PSI	MPa	PSI	MPa			
-6	10	3/8	0.80	20.2	6000	42.0	24000	168.0	65	71	6EFG6K-MTF
-8	12	1/2	0.95	24.0	6000	42.0	24000	168.0	90	89	8EFG6K-MTF
-10	16	5/8	1.09	27.6	6000	42.0	24000	168.0	100	115	10EFG6K-MTF
-12	19	3/4	1.24	31.4	6000	42.0	24000	168.0	120	144	12EFG6K-MTF
-16	25	1	1.53	38.7	6000	42.0	24000	168.0	150	223	16EFG6K-MTF
-20	31	1.1/4	1.97	50.0	6000	42.0	24000	168.0	210	399	20EFG6K-MTF
-24	38	1.1/2	2.26	57.4	6000	42.0	24000	168.0	250	482	24EFG6K-MTF
-32	51	2	2.80	71.1	6000	42.0	24000	168.0	635	719	32EFG6K-MTF

RECOMMENDED FOR	Extremely high pressure and high impulse hydraulic applications.
TUBE	NBR (Nitrile) based.
REINFORCEMENT	Four (six for -20 to -32) alternating layers of spiralled, high tensile steel wire.
COVER	CR (Chloroprene) based. MSHA approved.
TEMPERATURE RANGE	-40°C to +121°C. For water emulsions, etc. see Engineering and technical data page 292.
STANDARDS	Exceeds ISO 3862 R15. SAE 100R15. Meets or exceeds performance requirements of EN 856 4SP (-8 to -32) and EN 856 4SH (-12 to -32).
COUPLINGS	-6 to -20: GlobalSpiral; -24, -32: GlobalSpiral Maximum.
TYPE APPROVALS	DNV.
CHARACTERISTICS/BENEFITS	<ul style="list-style-type: none"> ■ Up to 40% of EN 856 4SP/4SH bend radius at rated working pressure. ■ Extremely flexible. ■ Superior flex impulse performance: tested to 1,000,000 impulse cycles at 50% of SAE 100R15 bend radii (except -32). ■ EFG6K-MTF hose is compatible with biodegradable hydraulic fluids like synthetic esters, polyglycols and vegetable oils as well as petroleum-based fluids. ■ Gates special MegaTuff cover offers 300 times the abrasion resistance of the standard EFG6K cover as per ISO 6945, superior ozone and weathering resistance.

IMPORTANT



Please consult Gates' Product Application Engineers for use of MegaTuff™ hose in reverse bending applications.

TABLE OF CONTENTS

ABOUT GATES

HYDRAULIC HOSE

HYDRAULIC HOSE COUPLINGS

ENGINEERING AND TECHNICAL DATA

MEGASYS™ SPIRAL WIRE AND XPIRAL™ HYDRAULIC HOSE



EFG5K

CONSTANT PRESSURE



-size	↻		⊘		⊙		🌀		⚙️	⚖️	📏
	DN	"	"	mm	PSI	MPa	PSI	MPa	mm	kg/100m	REF.
-6	10	3/8	0.80	20.2	5000	35.0	20000	140.0	65	71	6EFG5K
-8	12	1/2	0.95	24.0	5000	35.0	20000	140.0	90	89	8EFG5K
-10	16	5/8	1.09	27.6	5000	35.0	20000	140.0	100	115	10EFG5K
-12	19	3/4	1.24	31.4	5000	35.0	20000	140.0	120	144	12EFG5K
-16	25	1	1.53	38.7	5000	35.0	20000	140.0	150	223	16EFG5K
-20	31	1.1/4	1.97	50.0	5000	35.0	20000	140.0	210	399	20EFG5K
-24	38	1.1/2	2.26	57.4	5000	35.0	20000	140.0	250	482	24EFG5K
-32	51	2	2.80	71.1	5000	35.0	20000	140.0	635	719	32EFG5K

- RECOMMENDED FOR** Extremely high pressure and high impulse hydraulic applications.
- TUBE** NBR (Nitrile) based.
- REINFORCEMENT** Four (six for -20 to -32) alternating layers of spiralled, high tensile steel wire.
- COVER** CR (Chloroprene) based. MSHA approved.
- TEMPERATURE RANGE** -40°C to +121°C. For water emulsions, etc. see Engineering and technical data page 292.
- STANDARDS** Exceeds ISO 3862 R13. EN 856 R13. SAE 100R13.
Meets or exceeds performance requirements of EN 856 4SP (-10 to -32) and EN 856 4SH (-20 to -32).
- COUPLINGS** -6 to -20: GlobalSpiral; -24, -32: GlobalSpiral Maximum.
- TYPE APPROVALS** LR, BV and ABS.
- CHARACTERISTICS/BENEFITS**
- Up to 40% of EN 856 4SP/4SH bend radius at rated working pressure.
 - Extremely flexible.
 - Superior flex impulse performance: tested to 1,000,000 impulse cycles at 50% of EN 856 R13 and SAE 100R13 bend radii (except -32).
 - EFG5K hose is compatible with biodegradable hydraulic fluids like synthetic esters, polyglycols and vegetable oils as well as petroleum-based fluids.
- OPTIONAL**
-  EFG5KL: for low-temperature applications, Gates recommends the EFG5KL range down to -57°C constant.

TABLE OF CONTENTS

ABOUT GATES

HYDRAULIC HOSE

HYDRAULIC HOSE COUPLINGS

ENGINEERING AND TECHNICAL DATA

EFG5K XTRATUFF™ COVER

CONSTANT PRESSURE

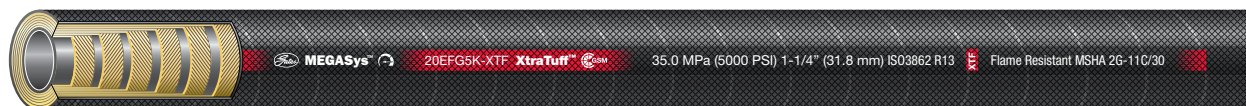

-size	↻		⊘		⊙		🔥		👂		🏋️	📏
	DN	"	"	mm	PSI	MPa	PSI	MPa	mm	kg/100m	REF.	
-6	10	3/8	0.80	20.2	5000	35.0	20000	140.0	65	71	6EFG5K-XTF	
-8	12	1/2	0.95	24.0	5000	35.0	20000	140.0	90	89	8EFG5K-XTF	
-10	16	5/8	1.09	27.6	5000	35.0	20000	140.0	100	115	10EFG5K-XTF	
-12	19	3/4	1.24	31.4	5000	35.0	20000	140.0	120	144	12EFG5K-XTF	
-16	25	1	1.53	38.7	5000	35.0	20000	140.0	150	223	16EFG5K-XTF	
-20	31	1.1/4	1.97	50.0	5000	35.0	20000	140.0	210	399	20EFG5K-XTF	

- RECOMMENDED FOR** Extremely high pressure and high impulse hydraulic applications.
- TUBE** NBR (Nitrile) based.
- REINFORCEMENT** Four (six for -20) alternating layers of spiralled, high tensile steel wire.
- COVER** CR (Chloroprene) based. MSHA approved.
- TEMPERATURE RANGE** -40°C to +121°C. For water emulsions, etc. see Engineering and technical data page 292.
- STANDARDS** Exceeds ISO 3862 R13. EN 856 R13. SAE 100R13.
Meets or exceeds performance requirements of EN 856 4SP (-10 to -20) and EN 856 4SH (-20).
- COUPLINGS** -6 to -20: GlobalSpiral.
- TYPE APPROVALS** DNV.
- CHARACTERISTICS/BENEFITS**
- Up to 40% of EN 856 4SP/4SH bend radius at rated working pressure.
 - Extremely flexible.
 - Superior flex impulse performance: tested to 1,000,000 impulse cycles at 50% of EN 856 R13 and SAE 100R13 bend radii (except -32).
 - EFG5K-XTF hose is compatible with biodegradable hydraulic fluids like synthetic esters, polyglycols and vegetable oils as well as petroleum-based fluids.
 - Gates special XtraTuff cover offers 25 times the abrasion resistance of the standard EFG5K cover as per ISO 6945.



EFG5K MEGATUFF™ COVER

CONSTANT PRESSURE

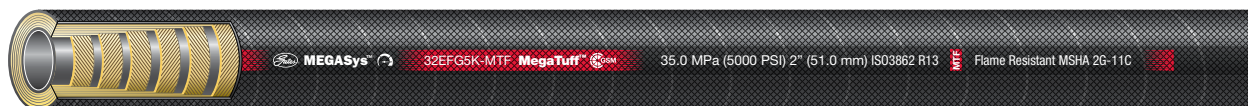

-size	↻		⊘		⊙		🌀		⤴	⚖	📏
	DN	"	"	mm	PSI	MPa	PSI	MPa	mm	kg/100m	REF.
-6	10	3/8	0.80	20.2	5000	35.0	20000	140.0	65	71	6EFG5K-MTF
-8	12	1/2	0.95	24.0	5000	35.0	20000	140.0	90	89	8EFG5K-MTF
-10	16	5/8	1.09	27.6	5000	35.0	20000	140.0	100	115	10EFG5K-MTF
-12	19	3/4	1.24	31.4	5000	35.0	20000	140.0	120	144	12EFG5K-MTF
-16	25	1	1.53	38.7	5000	35.0	20000	140.0	150	223	16EFG5K-MTF
-20	31	1.1/4	1.97	50.0	5000	35.0	20000	140.0	210	399	20EFG5K-MTF
-24	38	1.1/2	2.26	57.4	5000	35.0	20000	140.0	250	482	24EFG5K-MTF
-32	51	2	2.80	71.1	5000	35.0	20000	140.0	635	719	32EFG5K-MTF

- RECOMMENDED FOR** Extremely high pressure and high impulse hydraulic applications.
- TUBE** NBR (Nitrile) based.
- REINFORCEMENT** Four (six for -20 to -32) alternating layers of spiralled, high tensile steel wire.
- COVER** CR (Chloroprene) based. MSHA approved.
- TEMPERATURE RANGE** -40°C to +121°C. For water emulsions, etc. see Engineering and technical data page 292.
- STANDARDS** Exceeds ISO 3862 R13. EN 856 R13. SAE 100R13. Meets or exceeds performance requirements of EN 856 4SP (-10 to -32) and EN 856 4SH (-20 to -32).
- COUPLINGS** -6 to -20: GlobalSpiral; -24, -32: GlobalSpiral Maximum.
- TYPE APPROVALS** DNV.
- CHARACTERISTICS/BENEFITS**
 - Up to 40% of EN 856 4SP/4SH bend radius at rated working pressure.
 - Extremely flexible.
 - Superior flex impulse performance: tested to 1,000,000 impulse cycles at 50% of EN 856 R13 and SAE 100R13 bend radii (except -32).
 - EFG5K-MTF hose is compatible with biodegradable hydraulic fluids like synthetic esters, polyglycols and vegetable oils as well as petroleum-based fluids.
 - Gates special MegaTuff cover offers 300 times the abrasion resistance of the standard EFG5K cover as per ISO 6945, superior ozone and weathering resistance.

IMPORTANT



Please consult Gates' Product Application Engineers for use of MegaTuff™ hose in reverse bending applications.

TABLE OF CONTENTS

ABOUT GATES

HYDRAULIC HOSE

HYDRAULIC HOSE COUPLINGS

ENGINEERING AND TECHNICAL DATA



MXG5K XTRATUFF™ PLUS COVER

CONSTANT PRESSURE



-size	↻		⊘		⊙		🌀		⤴	⚖	📏
	DN	"	"	mm	PSI	MPa	PSI	MPa	mm	kg/100m	REF.
-6	10	3/8	0.71	18.0	5000	35.0	20000	140.0	65	43.8	6MXG5K-XTP
-8	12	1/2	0.85	21.6	5000	35.0	20000	140.0	90	61.0	8MXG5K-XTP
-10	16	5/8	1.03	26.1	5000	35.0	20000	140.0	100	88.3	10MXG5K-XTP
-12	19	3/4	1.16	29.6	5000	35.0	20000	140.0	120	107.0	12MXG5K-XTP

RECOMMENDED FOR

High pressure hydraulic applications. Easy to route and to install in tight areas. Alternative to spiral hoses in high pressure lines where flexibility is required.

TUBE

NBR (nitrile) based.

REINFORCEMENT

Woven spiral reinforcement with four layers of high-tensile steel wire.

COVER

Black, XtraTuff Plus synthetic rubber. MSHA approved.

TEMPERATURE RANGE

-40°C to +121°C. For water emulsions, etc. see Engineering and technical data page 292.

STANDARDS

Exceeds ISO 18752 350DC (GS couplings). Exceeds ISO 18752 350CC (G couplings). Exceeds performance criteria of ISO 3862 R13. Exceeds performance requirements of EN 856 4SP (-10 and -12).

COUPLINGS

GlobalSpiral (all sizes). MegaCrimp (size -6 to -8).

TYPE APPROVALS

DNV, LR, BV and ABS..

CHARACTERISTICS/BENEFITS

- Proprietary application of materials science and processing technology.
- Superior impulse performance: MXG5K-XTP utilizes GlobalSpiral (GS) couplings with 1,000,000 cycle impulse life and MegaCrimp (G) couplings are also valid for MXG5K-XTP size -06 and -08 with 600,000 cycle impulse life.
- Impulse tested to the same parameters as Gates EFG5K spiral hose (pressure, temperature and bend radius).
- Enhanced ozone & abrasion resistance.
- Highly flexible & lightweight.

IMPORTANT

MXG5K-XTP use the ferrules indicated in below table.



SIZE	GlobalSpiral™ GS Ferrules
-6	6GS1F-2
-8	8GS1F-2
-10	10GSID1F-4
-12	12GS1F-2



EFG4K

CONSTANT PRESSURE



-size	DN		mm		PSI		MPa		mm	kg/100m	REF.
	DN	"	"	mm	PSI	MPa	PSI	MPa			
-6	10	3/8	0.80	20.2	4000	28.0	16000	112.0	65	71	6EFG4K
-8	12	1/2	0.94	24.0	4000	28.0	16000	112.0	90	89	8EFG4K
-10	16	5/8	1.09	27.6	4000	28.0	16000	112.0	100	113	10EFG4K
-12	19	3/4	1.21	30.7	4000	28.0	16000	112.0	120	128	12EFG4K
-16	25	1	1.50	38.0	4000	28.0	16000	112.0	150	188	16EFG4K
-20	31	1.1/4	1.85	47.0	4000	28.0	16000	112.0	210	283	20EFG4K

RECOMMENDED FOR	Extremely high pressure and high impulse hydraulic applications.
TUBE	NBR (Nitrile) based.
REINFORCEMENT	Four alternating layers of spiralled, high tensile steel wire.
COVER	CR (Chloroprene) based. MSHA approved.
TEMPERATURE RANGE	-40°C to +121°C. For water emulsions, etc. see Engineering and technical data page 292.
STANDARDS	Exceeds ISO 3862 R12. EN 856 R12. SAE 100R12. Meets or exceeds performance requirements of EN 856 4SP (-16, -20).
COUPLINGS	GlobalSpiral.
TYPE APPROVALS	DNV, LR, BV and ABS.
CHARACTERISTICS/BENEFITS	<ul style="list-style-type: none"> ■ 40% of EN 856 4SP bend radius at rated working pressure. ■ Most flexible EN 856 R12 / SAE 100R12 hose in the industry. ■ Superior flex impulse performance: tested to 1,000,000 impulse cycles at 50% of EN 856 R12 and SAE 100R12 bend radii. ■ EFG4K hose is compatible with biodegradable hydraulic fluids like synthetic esters, polyglycols and vegetable oils as well as petroleum-based fluids.
OPTIONAL	 EFG4KL: for low-temperature applications, Gates recommends the EFG4KL range down to -57°C constant.

EFG4K XTRATUFF™ COVER

CONSTANT PRESSURE

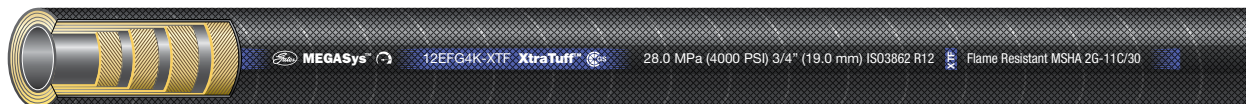

-size	↻		⊘		⊙		🔥		👂		📊	📏
	DN	"	"	mm	PSI	MPa	PSI	MPa	mm	kg/100m	REF.	
-6	10	3/8	0.80	20.2	4000	28.0	16000	112.0	65	71	6EFG4K-XTF	
-8	12	1/2	0.94	24.0	4000	28.0	16000	112.0	90	89	8EFG4K-XTF	
-10	16	5/8	1.09	27.6	4000	28.0	16000	112.0	100	113	10EFG4K-XTF	
-12	19	3/4	1.21	30.7	4000	28.0	16000	112.0	120	128	12EFG4K-XTF	
-16	25	1	1.50	38.0	4000	28.0	16000	112.0	150	188	16EFG4K-XTF	
-20	31	1.1/4	1.85	47.0	4000	28.0	16000	112.0	210	283	20EFG4K-XTF	

RECOMMENDED FOR	Extremely high pressure and high impulse hydraulic applications.
TUBE	NBR (Nitrile) based.
REINFORCEMENT	Four alternating layers of spiralled, high tensile steel wire.
COVER	CR (Chloroprene) based. MSHA approved.
TEMPERATURE RANGE	-40°C to +121°C. For water emulsions, etc. see Engineering and technical data page 292.
STANDARDS	Exceeds ISO 3862 R12. EN 856 R12. SAE 100R12. Meets or exceeds performance requirements of EN 856 4SP (-16, -20).
COUPLINGS	GlobalSpiral.
TYPE APPROVALS	DNV.
CHARACTERISTICS/BENEFITS	<ul style="list-style-type: none"> ■ 40% of EN 856 4SP bend radius at rated working pressure. ■ Most flexible EN 856 R12 / SAE 100R12 hose in the industry. ■ Superior flex impulse performance: tested to 1,000,000 impulse cycles at 50% of EN 856 R12 and SAE 100R12 bend radii. ■ EFG4K-XTF hose is compatible with biodegradable hydraulic fluids like synthetic esters, polyglycols and vegetable oils as well as petroleum-based fluids. ■ Gates special XtraTuff cover offers 25 times the abrasion resistance of the standard EFG4K cover as per ISO 6945.

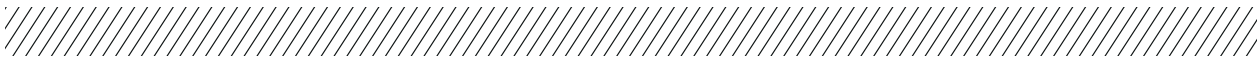

EFG4K MEGATUFF™ COVER

CONSTANT PRESSURE

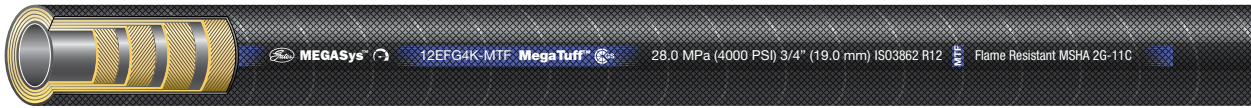

TABLE OF CONTENTS

ABOUT GATES

HYDRAULIC HOSE

HYDRAULIC HOSE COUPLINGS

ENGINEERING AND TECHNICAL DATA

-size	DN		mm		PSI		MPa		mm	kg/100m	REF.
	DN	"	"	mm	PSI	MPa	PSI	MPa			
-6	10	3/8	0.80	20.2	4000	28.0	16000	112.0	65	71	6EFG4K-MTF
-8	12	1/2	0.94	24.0	4000	28.0	16000	112.0	90	89	8EFG4K-MTF
-10	16	5/8	1.09	27.6	4000	28.0	16000	112.0	100	113	10EFG4K-MTF
-12	19	3/4	1.21	30.7	4000	28.0	16000	112.0	120	128	12EFG4K-MTF
-16	25	1	1.50	38.0	4000	28.0	16000	112.0	150	188	16EFG4K-MTF
-20	31	1.1/4	1.85	47.0	4000	28.0	16000	112.0	210	283	20EFG4K-MTF

- RECOMMENDED FOR** Extremely high pressure and high impulse hydraulic applications.
- TUBE** NBR (Nitrile) based.
- REINFORCEMENT** Four alternating layers of spiralled, high tensile steel wire.
- COVER** CR (Chloroprene) based. MSHA approved.
- TEMPERATURE RANGE** -40°C to +121°C. For water emulsions, etc. see Engineering and technical data page 292.
- STANDARDS** Exceeds ISO 3862 R12. EN 856 R12. SAE 100R12.
Meets or exceeds performance requirements of EN 856 4SP (-16, -20).
- COUPLINGS** GlobalSpiral.
- TYPE APPROVALS** DNV.
- CHARACTERISTICS/BENEFITS**
- 40% of EN 856 4SP bend radius at rated working pressure.
 - Most flexible EN 856 R12 / SAE 100R12 hose in the industry.
 - Superior flex impulse performance: tested to 1,000,000 impulse cycles at 50% of EN 856 R12 and SAE 100R12 bend radii.
 - EFG4K-MTF hose is compatible with biodegradable hydraulic fluids like synthetic esters, polyglycols and vegetable oils as well as petroleum-based fluids.
 - Gates special MegaTuff cover offers 300 times the abrasion resistance of the standard EFG4K cover as per ISO 6945, superior ozone and weathering resistance.
- IMPORTANT**



Please consult Gates' Product Application Engineers for use of MegaTuff™ hose in reverse bending applications.



MXG4K XTRATUFF™ PLUS COVER

CONSTANT PRESSURE



-size	↻		⊘		⊙		🌸		👂		🏋️	📏
	DN	"	"	mm	PSI	MPa	PSI	MPa	mm	kg/100m	REF.	
-6	10	3/8	0.70	17.7	4000	28.0	16000	112.0	65	38	6MXG4K-XTP	
-8	12	1/2	0.82	20.7	4000	28.0	16000	112.0	90	52	8MXG4K-XTP	
-10	16	5/8	0.99	25.2	4000	28.0	16000	112.0	100	69	10MXG4K-XTP	
-12	19	3/4	1.14	28.9	4000	28.0	16000	112.0	120	95	12MXG4K-XTP	
-16	25	1	1.50	38.0	4000	28.0	16000	112.0	150	157	16MXG4K-XTP	

RECOMMENDED FOR

High pressure hydraulic applications. Easy to route and to install in tight areas. Alternative to spiral hoses in high pressure lines where flexibility is required.

TUBE

NBR (nitrile) based.

REINFORCEMENT

Woven spiral reinforcement with four layers of high-tensile steel wire.

COVER

Black, XtraTuff Plus synthetic rubber. MSHA approved.

TEMPERATURE RANGE

-40°C to +121°C. For water emulsions, etc. see Engineering and technical data page 292.

STANDARDS

Exceeds ISO 18752 280DC (GS couplings). Exceeds ISO 18752 280CC (G couplings). SAE 100R19. Exceeds performance criteria of ISO 3862 R12. Size -16 also rated for EN 856 4SP.

COUPLINGS

GlobalSpiral (all sizes). MegaCrimp (size -6 to -12).

TYPE APPROVALS

DNV, LR, BV and ABS.

CHARACTERISTICS/BENEFITS

- Proprietary application of materials science and processing technology.
- Superior impulse performance: MXG4K-XTP utilizes GlobalSpiral (GS) couplings with 1,000,000 cycle impulse life and MegaCrimp (G) couplings are also valid for MXG4K-XTP from size -06 to -12 with 600,000 cycle impulse life.
- Impulse tested to the same parameters as Gates EFG4K spiral hose (pressure, temperature and bend radius).
- Highly flexible & lightweight.
- Enhanced ozone & abrasion resistance.

IMPORTANT

MXG4K-XTP use the ferrules indicated in below table..



SIZE	GlobalSpiral™ GS Ferrules
-6	GS1F-2
-8	GS1F-2
-10	GS1F-2
-12	GS1F-2
-16	GS1F-4



EFG3K

CONSTANT PRESSURE



-size	↻		⊘		⊙		🌸		⤴	⚖	📏
	DN	"	"	mm	PSI	MPa	PSI	MPa	mm	kg/100m	REF.
-20	31	1.1/4	1.85	47.0	3000	21.0	12000	84.0	210	282	20EFG3K
-24	38	1.1/2	2.11	53.6	3000	21.0	12000	84.0	250	320	24EFG3K
-32	51	2	2.63	66.8	3000	21.0	12000	84.0	635	439	32EFG3K

- RECOMMENDED FOR** Extremely high pressure and high impulse hydraulic applications.
- TUBE** NBR (Nitrile) based.
- REINFORCEMENT** Four alternating layers of spiralled, high tensile steel wire.
- COVER** CR (Chloroprene) based. MSHA approved.
- TEMPERATURE RANGE** -40°C to +121°C. For water emulsions, etc. see Engineering and technical data page 292.
- STANDARDS** Exceeds ISO 3862 R12. EN 856 R12. SAE 100R12.
Meets or exceeds performance requirements of EN 856 4SP.
- COUPLINGS** -20: GlobalSpiral; -24 to -32: GlobalSpiral Plus.
- TYPE APPROVALS** DNV, LR, BV and ABS.
- CHARACTERISTICS/BENEFITS**
- Up to 40% of EN 856 4SP bend radius at rated working pressure.
 - Extremely flexible.
 - Superior flex impulse performance: tested to 1,000,000 impulse cycles at 50% of EN 856 R12 and SAE 100R12 bend radii (except -32).
 - EFG3K hose is compatible with biodegradable hydraulic fluids like synthetic esters, polyglycols and vegetable oils as well as petroleum-based fluids.

TABLE OF CONTENTS

ABOUT GATES

HYDRAULIC HOSE

HYDRAULIC HOSE COUPLINGS

ENGINEERING AND TECHNICAL DATA

EFG3K MEGATUFF™ COVER

CONSTANT PRESSURE



-size	↻		⊘		⊙		🌸		👂		🏋️	📏
	DN	"	"	mm	PSI	MPa	PSI	MPa	mm	kg/100m	REF.	
-20	31	1.1/4	1.85	47.0	3000	21.0	12000	84.0	210	282	20EFG3K-MTF	
-24	38	1.1/2	2.11	53.6	3000	21.0	12000	84.0	250	320	24EFG3K-MTF	
-32	51	2	2.63	66.8	3000	21.0	12000	84.0	635	439	32EFG3K-MTF	

- RECOMMENDED FOR** Extremely high pressure and high impulse hydraulic applications.
- TUBE** NBR (Nitrile) based.
- REINFORCEMENT** Four alternating layers of spiralled, high tensile steel wire.
- COVER** CR (Chloroprene) based. MSHA approved.
- TEMPERATURE RANGE** -40°C to +121°C. For water emulsions, etc. see Engineering and technical data page 292.
- STANDARDS** Exceeds ISO 3862 R12. EN 856 R12. SAE 100R12.
Meets or exceeds performance requirements of EN 856 4SP.
- COUPLINGS** -20: GlobalSpiral; -24 to -32: GlobalSpiral Plus.
- TYPE APPROVALS** DNV.
- CHARACTERISTICS/BENEFITS**
- Up to 40% of EN 856 4SP bend radius at rated working pressure.
 - Extremely flexible.
 - Superior flex impulse performance: tested to 1,000,000 impulse cycles at 50% of EN 856 R12 and SAE 100R12 bend radii (except -32).
 - EFG3K-MTF hose is compatible with biodegradable hydraulic fluids like synthetic esters, polyglycols and vegetable oils as well as petroleum-based fluids.
 - Gates special MegaTuff cover offers 300 times the abrasion resistance of the standard EFG3K cover as per ISO 6945, superior ozone and weathering resistance.
- IMPORTANT**
- Please consult Gates' Product Application Engineers for use of MegaTuff™ hose in reverse bending applications.

TABLE OF CONTENTS

ABOUT GATES

HYDRAULIC HOSE

HYDRAULIC HOSE COUPLINGS

ENGINEERING AND TECHNICAL DATA



EFG6KL

CONSTANT PRESSURE



-size	↻		⊘		💡		🌸		👤		📦
	DN	"	"	mm	PSI	MPa	PSI	MPa	mm	kg/100m	REF.
-8	12	1/2	0.95	24.0	6000	42.0	24000	168.0	90	90	8EFG6KL
-10	16	5/8	1.09	27.6	6000	42.0	24000	168.0	100	115	10EFG6KL
-12	19	3/4	1.24	31.5	6000	42.0	24000	168.0	120	143	12EFG6KL
-16	25	1	1.53	38.9	6000	42.0	24000	168.0	150	192	16EFG6KL

RECOMMENDED FOR Extremely high pressure and high impulse hydraulic applications at extremely low temperatures.

TUBE NBR (Nitrile) based.

REINFORCEMENT Four alternating layers of spiralled, high tensile steel wire.

COVER CR (Chloroprene) based. MSHA approved.

TEMPERATURE RANGE -57°C to +100°C constant and +121°C intermittent.
For water emulsions, etc. see Engineering and technical data page 292.

STANDARDS Exceeds ISO 3862 R15. SAE 100R15.
Meets or exceeds performance requirements of EN 856 4SP / 4SH.

COUPLINGS GlobalSpiral.

- CHARACTERISTICS/BENEFITS**
- 40% of EN 856 4SP/4SH bend radius at rated working pressure.
 - Extremely flexible.
 - Superior flex impulse performance: tested to 1,000,000 impulse cycles at 50% of SAE 100R15 bend radii.
 - EFG6KL hose is compatible with biodegradable hydraulic fluids like synthetic esters, polyglycols and vegetable oils as well as petroleum-based fluids.

MEGASYS™ SPIRAL WIRE AND XPIRAL™ HYDRAULIC HOSE



EFG5KL

CONSTANT PRESSURE



-size	↻		⊘		⊙		🔥		👂		🏋️	📏
	DN	"	"	mm	PSI	MPa	PSI	MPa	mm	kg/100m	REF.	
-6	10	3/8	0.80	20.2	5000	35.0	20000	140.0	65	71	6EFG5KL	
-8	12	1/2	0.95	24.0	5000	35.0	20000	140.0	90	89	8EFG5KL	
-10	16	5/8	1.09	27.6	5000	35.0	20000	140.0	100	115	10EFG5KL	
-12	19	3/4	1.24	31.4	5000	35.0	20000	140.0	120	144	12EFG5KL	
-16	25	1	1.53	38.7	5000	35.0	20000	140.0	150	223	16EFG5KL	
-20	31	1.1/4	1.97	50.0	5000	35.0	20000	140.0	210	399	20EFG5KL	
-24	38	1.1/2	2.26	57.4	5000	35.0	20000	140.0	250	482	24EFG5KL	

RECOMMENDED FOR Extremely high pressure and high impulse hydraulic applications at extremely low temperatures.

TUBE NBR (Nitrile) based.

REINFORCEMENT Four (six for -20 and -24) alternating layers of spiralled, high tensile steel wire.

COVER CR (Chloroprene) based. MSHA approved.

TEMPERATURE RANGE -57°C to +100°C constant and +121°C intermittent. For water emulsions, etc. see Engineering and technical data page 292.

STANDARDS Exceeds ISO 3862 R13. SAE 100R13.
Meets or exceeds performance requirements of EN 856 4SP.

COUPLINGS GlobalSpiral.

- CHARACTERISTICS/BENEFITS**
- 40% of EN 856 4SP/4SH bend radius at rated working pressure.
 - Extremely flexible.
 - Superior flex impulse performance: tested to 1,000,000 impulse cycles at 50% of SAE 100R13 bend radii.
 - EFG5KL hose is compatible with biodegradable hydraulic fluids like synthetic esters, polyglycols and vegetable oils as well as petroleum-based fluids.

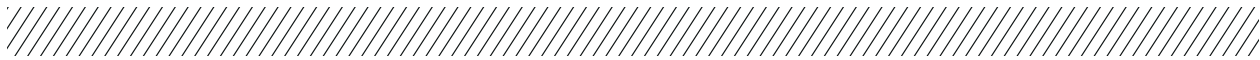

EFG4KL

CONSTANT PRESSURE



↻			⊘		⊙		🌸		📏		📊
-size	DN	"	"	mm	PSI	MPa	PSI	MPa	mm	kg/100m	REF.
-6	10	3/8	0.81	20.6	4000	28.0	16000	112.0	65	71	6EFG4KL
-8	12	1/2	0.95	24.0	4000	28.0	16000	112.0	90	89	8EFG4KL
-12	19	3/4	1.21	30.7	4000	28.0	16000	112.0	120	128	12EFG4KL
-16	25	1	1.49	37.8	4000	28.0	16000	112.0	150	188	16EFG4KL
-20	31	1.1/4	1.85	47.0	4000	28.0	16000	112.0	210	283	20EFG4KL

RECOMMENDED FOR Extremely high pressure and high impulse hydraulic applications at extremely low temperatures.

TUBE NBR (Nitrile) based.

REINFORCEMENT Four alternating layers of spiralled, high tensile steel wire.

COVER CR (Chloroprene) based. MSHA approved.

TEMPERATURE RANGE -57°C to +100°C constant and +121°C intermittent.
For water emulsions, etc. see Engineering and technical data page 292.

STANDARDS Exceeds ISO 3862 R12. SAE 100R12.
Meets or exceeds performance requirements of EN 856 4SP.

COUPLINGS GlobalSpiral.

- CHARACTERISTICS/BENEFITS**
- 40% of EN 856 4SP bend radius at rated working pressure.
 - Extremely flexible.
 - Superior flex impulse performance: tested to 1,000,000 impulse cycles at 50% of SAE 100R12 bend radii.
 - EFG4KL hose is compatible with biodegradable hydraulic fluids like synthetic esters, polyglycols and vegetable oils as well as petroleum-based fluids.



**MEGASYS™ WIRE
AND TEXTILE BRAID
HYDRAULIC HOSE**



MEGASYS™ WIRE AND TEXTILE BRAID HYDRAULIC HOSE

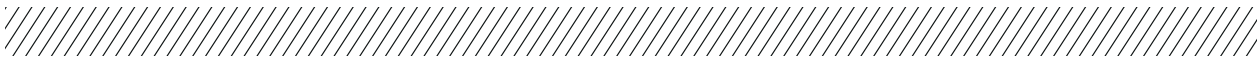

M6K

CONSTANT PRESSURE

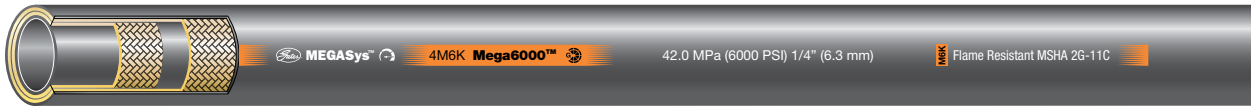

-size	DN	"	"	mm	PSI	MPa	PSI	MPa	mm	kg/100m	REF.
-4	6	1/4	0.58	14.9	6000	42.0	24000	168.0	50	35	4M6K

RECOMMENDED FOR	High pressure hydraulic applications. Easy to route and to install in tight areas.
TUBE	NBR (Nitrile) based.
REINFORCEMENT	Two braids of high tensile steel wire.
COVER	NBR/PVC based. MSHA approved.
TEMPERATURE RANGE	-40°C to +100°C. For water emulsions, etc. see Engineering and technical data page 292.
STANDARDS	Gates proprietary. Meets or exceeds EN 857 2SC performance requirements.
COUPLINGS	MegaCrimp™.
TYPE APPROVALS	DNV, LR and BV.
CHARACTERISTICS/BENEFITS	<ul style="list-style-type: none"> ■ 70% of EN 857 2SC and 50% of EN 853 2SN bend radius at rated working pressure. ■ Superior flex impulse performance: tested to 600,000 impulse cycles. ■ Lightweight. ■ M6K hose is compatible with biodegradable hydraulic fluids like synthetic esters, polyglycols and vegetable oils as well as petroleum-based fluids.

TABLE OF CONTENTS

ABOUT GATES

HYDRAULIC HOSE

HYDRAULIC HOSE COUPLINGS

ENGINEERING AND TECHNICAL DATA

MEGASYS™ WIRE AND TEXTILE BRAID HYDRAULIC HOSE



M5K

CONSTANT PRESSURE



-size	↻		⊘		⊙		🔥		⚖️		REF.
	DN	"	"	mm	PSI	MPa	PSI	MPa	mm	kg/100m	
-4	6	1/4	0.54	13.7	5000	35.0	20000	140.0	50	30	4M5K
-5	8	5/16	0.61	15.4	5000	35.0	20000	140.0	55	34	5M5K
-6	10	3/8	0.69	17.5	5000	35.0	20000	140.0	65	41	6M5K
-8	12	1/2	0.86	21.9	5000	35.0	20000	140.0	90	66	8M5K

RECOMMENDED FOR	High pressure hydraulic applications. Easy to route and to install in tight areas.
TUBE	NBR (Nitrile) based.
REINFORCEMENT	Two braids of high tensile steel wire.
COVER	NBR/PVC based. MSHA approved.
TEMPERATURE RANGE	-40°C to +100°C. For water emulsions, etc. see Engineering and technical data page 292.
STANDARDS	Gates proprietary. Meets or exceeds EN 857 2SC performance requirements.
COUPLINGS	MegaCrimp™.
TYPE APPROVALS	DNV, LR and BV.
CHARACTERISTICS/BENEFITS	<ul style="list-style-type: none"> ■ 70% of EN 857 2SC and 50% of EN 853 2SN bend radius at rated working pressure. ■ Superior flex impulse performance: tested to 600,000 impulse cycles. ■ Lightweight. ■ M5K hose is compatible with biodegradable hydraulic fluids like synthetic esters, polyglycols and vegetable oils as well as petroleum-based fluids.

TABLE OF CONTENTS

ABOUT GATES

HYDRAULIC HOSE

HYDRAULIC HOSE COUPLINGS

ENGINEERING AND TECHNICAL DATA



M5K XTRATUFF™ COVER

CONSTANT PRESSURE



-size	↻		⊘		⊙		🌸		⤴	⚖	📏
	DN	"	"	mm	PSI	MPa	PSI	MPa	mm	kg/100m	REF.
-4	6	1/4	0.54	13.7	5000	35.0	20000	140.0	50	30	4M5K-XTF
-6	10	3/8	0.69	17.5	5000	35.0	20000	140.0	65	41	6M5K-XTF
-8	12	1/2	0.86	21.9	5000	35.0	20000	140.0	90	66	8M5K-XTF

- RECOMMENDED FOR** High pressure hydraulic applications. Easy to route and to install in tight areas.
- TUBE** NBR (Nitrile) based.
- REINFORCEMENT** Two braids of high tensile steel wire.
- COVER** NBR/PVC based. MSHA approved.
- TEMPERATURE RANGE** -40°C to +100°C. For water emulsions, etc. see Engineering and technical data page 292.
- STANDARDS** Gates proprietary.
Meets or exceeds EN 857 2SC performance requirements.
- COUPLINGS** MegaCrimp™.
- TYPE APPROVALS** DNV.
- CHARACTERISTICS/BENEFITS**
- 70% of EN 857 2SC and 50% of EN 853 2SN bend radius at rated working pressure.
 - Superior flex impulse performance: tested to 600,000 impulse cycles.
 - Lightweight.
 - M5K-XTF hose is compatible with biodegradable hydraulic fluids like synthetic esters, polyglycols and vegetable oils as well as petroleum-based fluids.
 - Gates special XtraTuff cover offers 25 times the abrasion resistance of the standard M5K cover as per ISO 6945.

M5K MEGATUFF™ COVER

CONSTANT PRESSURE



-size									mm	kg/100m	REF.
	DN	"	"	mm	PSI	MPa	PSI	MPa			
-4	6	1/4	0.54	13.7	5000	35.0	20000	140.0	50	30	4M5K-MTF
-6	10	3/8	0.69	17.5	5000	35.0	20000	140.0	65	41	6M5K-MTF
-8	12	1/2	0.86	21.9	5000	35.0	20000	140.0	90	66	8M5K-MTF

RECOMMENDED FOR

High pressure hydraulic applications. Easy to route and to install in tight areas.

TUBE

NBR (Nitrile) based.

REINFORCEMENT

Two braids of high tensile steel wire.

COVER

NBR/PVC based. MSHA approved.

TEMPERATURE RANGE

-40°C to +100°C. For water emulsions, etc. see Engineering and technical data page 292.

STANDARDS

Gates proprietary.
Meets or exceeds EN 857 2SC performance requirements.

COUPLINGS

MegaCrimp™.

TYPE APPROVALS

DNV.

CHARACTERISTICS/BENEFITS

- 70% of EN 857 2SC and 50% of EN 853 2SN bend radius at rated working pressure.
- Superior flex impulse performance: tested to 600,000 impulse cycles.
- Lightweight.
- M5K-MTF hose is compatible with biodegradable hydraulic fluids like synthetic esters, polyglycols and vegetable oils as well as petroleum-based fluids.
- Gates special MegaTuff cover offers 300 times the abrasion resistance of the standard M5K cover as per ISO 6945, superior ozone and weathering resistance.

IMPORTANT



Please consult Gates' Product Application Engineers for use of MegaTuff™ hose in reverse bending applications.

MEGASYS™ WIRE AND TEXTILE BRAID HYDRAULIC HOSE

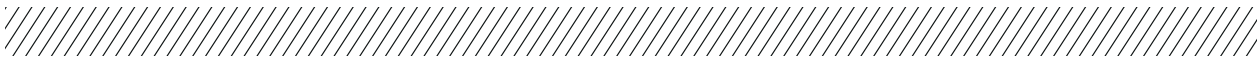

M4K

CONSTANT PRESSURE

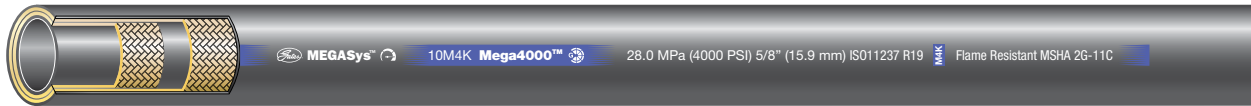

-size	↻		⊘		⊙		🌿		⤴	⚖	📏
	DN	"	"	mm	PSI	MPa	PSI	MPa	mm	kg/100m	REF.
-4	6	1/4	0.54	13.7	4000	28.0	16000	112.0	40	33	4M4K
-5	8	5/16	0.61	15.4	4000	28.0	16000	112.0	45	34	5M4K
-6	10	3/8	0.69	17.5	4000	28.0	16000	112.0	50	46	6M4K
-8	12	1/2	0.82	20.8	4000	28.0	16000	112.0	70	51	8M4K
-10	16	5/8	0.98	25.0	4000	28.0	16000	112.0	75	74	10M4K
-12	19	3/4	1.15	29.1	4000	28.0	16000	112.0	95	93	12M4K

- RECOMMENDED FOR** High pressure hydraulic applications. Easy to route and to install in extremely tight areas.
- TUBE** NBR (Nitrile) based.
- REINFORCEMENT** Two braids of high tensile steel wire.
- COVER** NBR/PVC based. MSHA approved.
- TEMPERATURE RANGE** -40°C to +100°C. For water emulsions, etc. see Engineering and technical data page 292.
- STANDARDS** Exceeds ISO 11237 R19. SAE 100R19.
Meets or exceeds EN 857 2SC performance requirements.
- COUPLINGS** MegaCrimp™.
- TYPE APPROVALS** DNV, LR, BV and ABS.
- CHARACTERISTICS/BENEFITS**
- 50% of EN 857 2SC and 40% of EN 853 2SN bend radius at rated working pressure.
 - Alternative to spiral hoses in high pressure lines where flexibility is required.
 - Superior flex impulse performance: tested to 600,000 impulse cycles.
 - Lightweight.
 - M4K hose is compatible with biodegradable hydraulic fluids like synthetic esters, polyglycols and vegetable oils as well as petroleum-based fluids.

OPTIONAL



For high-temperature applications, Gates recommends the M4KH hose range up to +1 °C constant.



M4KL: for low-temperature applications, Gates recommends the M4KL range down to -57°C constant.

TABLE OF CONTENTS

ABOUT GATES

HYDRAULIC HOSE

HYDRAULIC HOSE COUPLINGS

ENGINEERING AND TECHNICAL DATA

M4K XTRATUFF™ COVER

CONSTANT PRESSURE

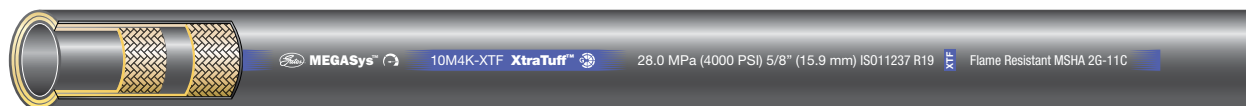

-size	↻		⊘		⊙		🌿		👤		REF.
	DN	"	"	mm	PSI	MPa	PSI	MPa	mm	kg/100m	
-4	6	1/4	0.54	13.7	4000	28.0	16000	112.0	40	33	4M4K-XTF
-5	8	5/16	0.61	15.4	4000	28.0	16000	112.0	45	34	5M4K-XTF
-6	10	3/8	0.69	17.5	4000	28.0	16000	112.0	50	46	6M4K-XTF
-8	12	1/2	0.82	20.8	4000	28.0	16000	112.0	70	51	8M4K-XTF
-10	16	5/8	0.98	25.0	4000	28.0	16000	112.0	75	74	10M4K-XTF
-12	19	3/4	1.15	29.1	4000	28.0	16000	112.0	95	93	12M4K-XTF

RECOMMENDED FOR

High pressure hydraulic applications. Easy to route and to install in extremely tight areas.

TUBE

NBR (Nitrile) based.

REINFORCEMENT

Two braids of high tensile steel wire.

COVER

NBR/PVC based. MSHA approved.

TEMPERATURE RANGE

-40°C to +100°C. For water emulsions, etc. see Engineering and technical data page 292.

STANDARDS

Exceeds ISO 11237 R19. SAE 100R19.
Meets or exceeds EN 857 2SC performance requirements.

COUPLINGS

MegaCrimp™.

TYPE APPROVALS

DNV.

CHARACTERISTICS/BENEFITS

- 50% of EN 857 2SC and 40% of EN 853 2SN bend radius at rated working pressure.
- Alternative to spiral hoses in high pressure lines where flexibility is required.
- Superior flex impulse performance: tested to 600,000 impulse cycles.
- Lightweight.
- M4K-XTF hose is compatible with biodegradable hydraulic fluids like synthetic esters, polyglycols and vegetable oils as well as petroleum-based fluids.
- Gates special XtraTuff cover offers 25 times the abrasion resistance of the standard M4K cover as per ISO 6945.

OPTIONAL



For high-temperature applications, Gates recommends the M4KH hose range up to +1 °C constant.



M4K MEGATUFF™ COVER

CONSTANT PRESSURE

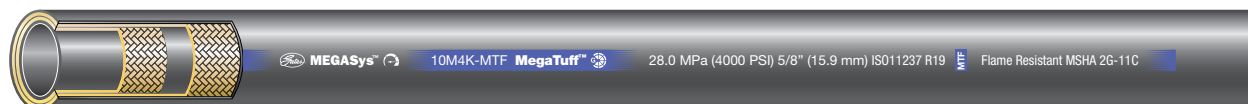

-size	↻		⊘		⊙		🌿		👤	🏋️	📏
	DN	"	"	mm	PSI	MPa	PSI	MPa	mm	kg/100m	REF.
-4	6	1/4	0.54	13.7	4000	28.0	16000	112.0	40	33	4M4K-MTF
-5	8	5/16	0.61	15.4	4000	28.0	16000	112.0	45	34	5M4K-MTF
-6	10	3/8	0.69	17.5	4000	28.0	16000	112.0	50	46	6M4K-MTF
-8	12	1/2	0.82	20.8	4000	28.0	16000	112.0	70	51	8M4K-MTF
-10	16	5/8	0.98	25.0	4000	28.0	16000	112.0	75	74	10M4K-MTF
-12	19	3/4	1.15	29.1	4000	28.0	16000	112.0	95	93	12M4K-MTF

RECOMMENDED FOR High pressure hydraulic applications. Easy to route and to install in extremely tight areas.

TUBE NBR (Nitrile) based.

REINFORCEMENT Two braids of high tensile steel wire.

COVER NBR/PVC based. MSHA approved.

TEMPERATURE RANGE -40°C to +100°C. For water emulsions, etc. see Engineering and technical data page 292.

STANDARDS Exceeds ISO 11237 R19. SAE 100R19.
Meets or exceeds EN 857 2SC performance requirements.

COUPLINGS MegaCrimp™.

TYPE APPROVALS DNV.

- CHARACTERISTICS/BENEFITS**
- 50% of EN 857 2SC and 40% of EN 853 2SN bend radius at rated working pressure.
 - Alternative to spiral hoses in high pressure lines where flexibility is required.
 - Superior flex impulse performance: tested to 600,000 impulse cycles.
 - Lightweight.
 - M4K-MTF hose is compatible with biodegradable hydraulic fluids like synthetic esters, polyglycols and vegetable oils as well as petroleum-based fluids.
 - Gates special MegaTuff cover offers 300 times the abrasion resistance of the standard M4K cover as per ISO 6945, superior ozone and weathering resistance.

OPTIONAL  For high-temperature applications, Gates recommends the M4KH-MTF hose range up to +1 °C constant.

IMPORTANT  Please consult Gates' Product Application Engineers for use of MegaTuff™ hose in reverse bending applications.

TABLE OF CONTENTS

ABOUT GATES

HYDRAULIC HOSE

HYDRAULIC HOSE COUPLINGS

ENGINEERING AND TECHNICAL DATA

MEGASYS™ WIRE AND TEXTILE BRAID HYDRAULIC HOSE

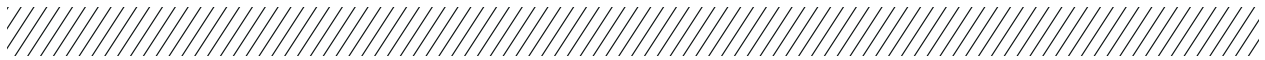

M3K

CONSTANT PRESSURE

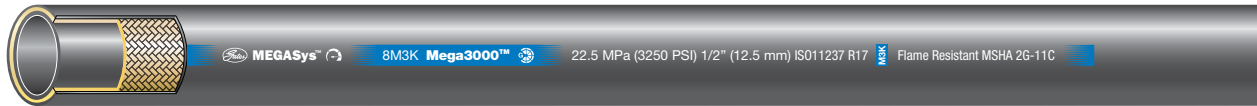

-size	↻		⊘		⊙		🔥		⤴	⚖	📏
	DN	"	"	mm	PSI	MPa	PSI	MPa	mm	kg/100m	REF.
-4	6	1/4	0.48	12.2	3250	22.5	13000	90.0	40	17	4M3K
-5	8	5/16	0.59	15.1	3250	22.5	13000	90.0	45	26	5M3K
-6	10	3/8	0.63	16.0	3250	22.5	13000	90.0	50	28	6M3K
-8	12	1/2	0.80	20.2	3250	22.5	13000	90.0	70	41	8M3K
-10	16	5/8	0.99	25.2	3250	22.5	13000	90.0	75	73	10M3K
-12	19	3/4	1.14	29.0	3250	22.5	13000	90.0	95	91	12M3K
-16	25	1	1.48	37.7	3250	22.5	13000	90.0	115	155	16M3K

RECOMMENDED FOR

High pressure hydraulic applications. Easy to route and to install in extremely tight areas.

TUBE

NBR (Nitrile) based.

REINFORCEMENT

-4 to -8: one braid of high tensile steel wire; -10 to -16: two braids of high tensile steel wire.

COVER

NBR/PVC based. MSHA approved.

TEMPERATURE RANGE

-40°C to +100°C. For water emulsions, etc. see Engineering and technical data page 292.

STANDARDS

Exceeds ISO 11237 R17. SAE 100R17.
Meets or exceeds EN 857 1SC/2SC performance requirements.

COUPLINGS

MegaCrimp™.

TYPE APPROVALS

DNV, LR, BV and ABS.

CHARACTERISTICS/BENEFITS

- 70% of EN 857 1SC/2SC and 50% of EN 853 1SN/2SN bend radius at rated working pressure.
- Superior flex impulse performance: tested to 600,000 impulse cycles.
- Exceeds working pressure requirements of R17.
- Lightweight.
- M3K hose is compatible with biodegradable hydraulic fluids like synthetic esters, polyglycols and vegetable oils as well as petroleum-based fluids.

OPTIONAL



For high-temperature applications, Gates recommends the M3KH hose range up to +121°C constant.



M3K XTRATUFF™ COVER

CONSTANT PRESSURE

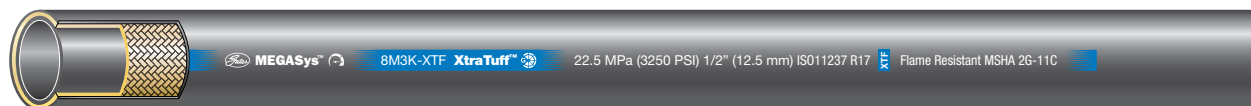

-size	DN		mm		PSI		MPa		mm	kg/100m	REF.
	DN	"	"	mm	PSI	MPa	PSI	MPa			
-4	6	1/4	0.48	12.2	3250	22.5	13000	90.0	40	17	4M3K-XTF
-5	8	5/16	0.59	15.1	3250	22.5	13000	90.0	45	26	5M3K-XTF
-6	10	3/8	0.63	16.0	3250	22.5	13000	90.0	50	28	6M3K-XTF
-8	12	1/2	0.80	20.2	3250	22.5	13000	90.0	70	41	8M3K-XTF
-10	16	5/8	0.99	25.2	3250	22.5	13000	90.0	75	73	10M3K-XTF
-12	19	3/4	1.14	29.0	3250	22.5	13000	90.0	95	91	12M3K-XTF
-16	25	1	1.48	37.7	3250	22.5	13000	90.0	115	155	16M3K-XTF

RECOMMENDED FOR

High pressure hydraulic applications. Easy to route and to install in extremely tight areas.

TUBE

NBR (Nitrile) based.

REINFORCEMENT

-4 to -8: one braid of high tensile steel wire; -10 to -16: two braids of high tensile steel wire.

COVER

NBR/PVC based. MSHA approved.

TEMPERATURE RANGE

-40°C to +100°C. For water emulsions, etc. see Engineering and technical data page 292.

STANDARDS

Exceeds ISO 11237 R17. SAE 100R17.
Meets or exceeds EN 857 1SC/2SC performance requirements.

COUPLINGS

MegaCrimp™.

TYPE APPROVALS

DNV.

CHARACTERISTICS/BENEFITS

- 70% of EN 857 1SC/2SC and 50% of EN 853 1SN/2SN bend radius at rated working pressure.
- Superior flex impulse performance: tested to 600,000 impulse cycles.
- Exceeds working pressure requirements of R17.
- Lightweight.
- M3K-XTF hose is compatible with biodegradable hydraulic fluids like synthetic esters, polyglycols and vegetable oils as well as petroleum-based fluids.
- Gates special XtraTuff cover offers 25 times the abrasion resistance of the standard M3K cover as per ISO 6945.

TABLE OF CONTENTS

ABOUT GATES

HYDRAULIC HOSE

HYDRAULIC HOSE COUPLINGS

ENGINEERING AND TECHNICAL DATA

M3K MEGATUFF™ COVER

CONSTANT PRESSURE

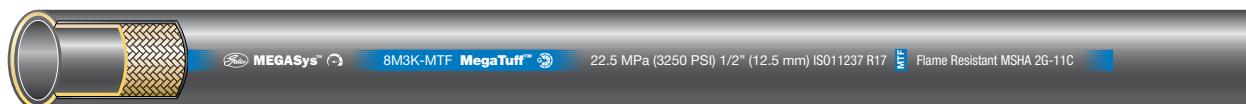

-size											REF.
	DN	"	"	mm	PSI	MPa	PSI	MPa	mm	kg/100m	
-4	6	1/4	0.48	12.2	3250	22.5	13000	90.0	40	17	4M3K-MTF
-5	8	5/16	0.59	15.1	3250	22.5	13000	90.0	45	26	5M3K-MTF
-6	10	3/8	0.63	16.0	3250	22.5	13000	90.0	50	28	6M3K-MTF
-8	12	1/2	0.80	20.2	3250	22.5	13000	90.0	70	41	8M3K-MTF
-10	16	5/8	0.99	25.2	3250	22.5	13000	90.0	75	73	10M3K-MTF
-12	19	3/4	1.14	29.0	3250	22.5	13000	90.0	95	91	12M3K-MTF
-16	25	1	1.48	37.7	3250	22.5	13000	90.0	115	155	16M3K-MTF

RECOMMENDED FOR

High pressure hydraulic applications. Easy to route and to install in extremely tight areas.

TUBE

NBR (Nitrile) based.

REINFORCEMENT

-4 to -8: one braid of high tensile steel wire; -10 to -16: two braids of high tensile steel wire.

COVER

NBR/PVC based. MSHA approved.

TEMPERATURE RANGE

-40°C to +100°C. For water emulsions, etc. see Engineering and technical data page 292.

STANDARDS

Exceeds ISO 11237 R17. SAE 100R17.
Meets or exceeds EN 857 1SC/2SC performance requirements.

COUPLINGS

MegaCrimp™.

TYPE APPROVALS

DNV.

CHARACTERISTICS/BENEFITS

- 70% of EN 857 1SC/2SC and 50% of EN 853 1SN/2SN bend radius at rated working pressure.
- Superior flex impulse performance: tested to 600,000 impulse cycles.
- Exceeds working pressure requirements of R17.
- Lightweight.
- M3K-MTF hose is compatible with biodegradable hydraulic fluids like synthetic esters, polyglycols and vegetable oils as well as petroleum-based fluids.

OPTIONAL



For high-temperature applications, Gates recommends the M3KH-MTF hose range up to +121°C constant.

IMPORTANT



Please consult Gates' Product Application Engineers for use of MegaTuff™ hose in reverse bending applications.



M2T

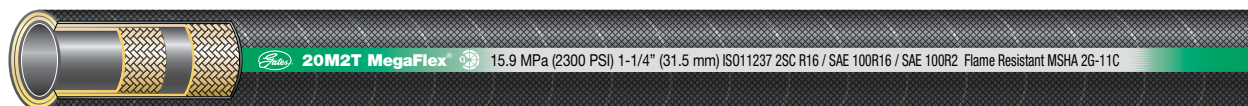

-size	↺		↻		⚙		🌿		👤	🏋	📏
	DN	"	"	mm	PSI	MPa	PSI	MPa	mm	kg/100m	REF.
-4	6	1/4	0.56	14.0	6000	42.0	24000	168.0	40	30	4M2T
-5	8	5/16	0.60	15.2	5500	38.0	22000	152.0	45	33	5M2T
-6	10	3/8	0.70	17.8	5000	35.0	20000	140.0	50	45	6M2T
-8	12	1/2	0.82	20.8	4300	29.6	17200	118.4	70	55	8M2T
-10	16	5/8	0.95	24.1	3800	26.2	15200	104.8	75	67	10M2T
-12	19	3/4	1.11	28.2	3500	24.1	14000	96.4	95	80	12M2T
-16	25	1	1.39	35.3	2500	17.2	10000	68.8	115	141	16M2T
-20	31	1.1/4	1.67	42.3	2300	15.9	9200	63.6	210	225	20M2T
-24	38	1.1/2	2.00	50.8	2000	14.0	8000	56.0	250	263	24M2T
-32	51	2	2.53	64.3	1500	10.3	6000	41.2	315	335	32M2T

- RECOMMENDED FOR** High pressure hydraulic applications. Easy to route and to install in tight areas.
- TUBE** NBR (Nitrile) based.
- REINFORCEMENT** Two braids of high tensile steel wire.
- COVER** NBR/PVC based. MSHA approved.
- TEMPERATURE RANGE** -40°C to +100°C. For water emulsions, etc. see Engineering and technical data page 292.
- STANDARDS** Exceeds ISO 11237 R16.
Exceeds ISO 1436 2SN R2 and SAE 100R2 performance.
Exceeds EN 857 2SC and EN 853 2SN performance.
- COUPLINGS** -4 to -20: MegaCrimp™; -24, -32: GlobalSpiral Plus.
- TYPE APPROVALS** DNV, LR, BV and ABS.
- CHARACTERISTICS/BENEFITS**
 - Superior flex impulse performance: tested to 600,000 impulse cycles at 50% of EN8572SCbendradii.
 - Higher working pressure than ISO 11237 2SC R16.
 - Lightweight.
 - M2T hose is compatible with biodegradable hydraulic fluids like synthetic esters, polyglycols and vegetable oils as well as petroleum-based fluids.

TABLE OF CONTENTS

ABOUT GATES

HYDRAULIC HOSE

HYDRAULIC HOSE COUPLINGS

ENGINEERING AND TECHNICAL DATA

M2T XTRATUFF™ COVER



-size									mm	kg/100m	REF.
	DN	"	"	mm	PSI	MPa	PSI	MPa			
-4	6	1/4	0.56	14.0	6000	42.0	24000	168.0	40	30	4M2T-XTF
-5	8	5/16	0.60	15.2	5500	38.0	22000	152.0	45	33	5M2T-XTF
-6	10	3/8	0.70	17.8	5000	35.0	20000	140.0	50	45	6M2T-XTF
-8	12	1/2	0.82	20.8	4300	29.6	17200	118.4	70	55	8M2T-XTF
-10	16	5/8	0.95	24.1	3800	26.2	15200	104.8	75	67	10M2T-XTF
-12	19	3/4	1.11	28.2	3500	24.1	14000	96.4	95	80	12M2T-XTF
-16	25	1	1.39	35.3	2500	17.2	10000	68.8	115	141	16M2T-XTF
-20	31	1.1/4	1.67	42.3	2300	15.9	9200	63.6	210	225	20M2T-XTF
-24	38	1.1/2	2.00	50.8	2000	14.0	8000	56.0	250	263	24M2T-XTF
-32	51	2	2.53	64.3	1500	10.3	6000	41.2	315	335	32M2T-XTF

- RECOMMENDED FOR** High pressure hydraulic applications. Easy to route and to install in tight areas.
- TUBE** NBR (Nitrile) based.
- REINFORCEMENT** Two braids of high tensile steel wire.
- COVER** NBR (Nitrile) based. MSHA approved.
- TEMPERATURE RANGE** -40°C to +100°C. For water emulsions, etc. see Engineering and technical data page 292.
- STANDARDS** Exceeds ISO 11237 R16.
Exceeds ISO 1436 2SN R2 and SAE 100R2 performance.
Exceeds EN 857 2SC and EN 853 2SN performance.
- COUPLINGS** -4 to -20: MegaCrimp™; -24, -32: GlobalSpiral Plus.
- TYPE APPROVALS** DNV.
- CHARACTERISTICS/BENEFITS**
- Superior flex impulse performance: tested to 600,000 impulse cycles at 50% of EN8572SCbendradii.
 - Higher working pressure than ISO 11237 2SC R16.
 - Lightweight.
 - M2T-XTF hose is compatible with biodegradable hydraulic fluids like synthetic esters, polyglycols and vegetable oils as well as petroleum-based fluids.
 - Gates special XtraTuff cover offers 25 times the abrasion resistance of the standard M2T cover as per ISO 6945.



M2T MEGATUFF™ COVER



-size	↻		⊘		⊙		🌿		⤴	⚖	📏
	DN	"	"	mm	PSI	MPa	PSI	MPa	mm	kg/100m	REF.
-4	6	1/4	0.56	14.0	6000	42.0	24000	168.0	40	30	4M2T-MTF
-5	8	5/16	0.60	15.2	5500	38.0	22000	152.0	45	33	5M2T-MTF
-6	10	3/8	0.70	17.8	5000	35.0	20000	140.0	50	45	6M2T-MTF
-8	12	1/2	0.82	20.8	4300	29.6	17200	118.4	70	55	8M2T-MTF
-10	16	5/8	0.95	24.1	3800	26.2	15200	104.8	75	67	10M2T-MTF
-12	19	3/4	1.11	28.2	3500	24.1	14000	96.4	95	80	12M2T-MTF
-16	25	1	1.39	35.3	2500	17.2	10000	68.8	115	141	16M2T-MTF

RECOMMENDED FOR	High pressure hydraulic applications. Easy to route and to install in tight areas.
TUBE	NBR (Nitrile) based.
REINFORCEMENT	Two braids of high tensile steel wire.
COVER	NBR (Nitrile) based. MSHA approved.
TEMPERATURE RANGE	-40°C to +100°C. For water emulsions, etc. see Engineering and technical data page 292.
STANDARDS	Exceeds ISO 11237 R16. Exceeds ISO 1436 2SN R2 and SAE 100R2 performance. Exceeds EN 857 2SC and EN 853 2SN performance.
COUPLINGS	MegaCrimp™.
TYPE APPROVALS	DNV.
CHARACTERISTICS/BENEFITS	<ul style="list-style-type: none"> ■ Superior flex impulse performance: tested to 600,000 impulse cycles at 50% of EN8572SCbendradii. ■ Higher working pressure than ISO 11237 2SC R16. ■ Lightweight. ■ M2T-MTF hose is compatible with biodegradable hydraulic fluids like synthetic esters, polyglycols and vegetable oils as well as petroleum-based fluids. ■ Gates special MegaTuff cover offers 300 times the abrasion resistance of the standard M2T cover as per ISO 6945, superior ozone and weathering resistance.



MXT



-size											
	DN	"	"	mm	PSI	MPa	PSI	MPa	mm	kg/100m	REF.
-4	6	1/4	0.56	14.0	6000	42.0	24000	168.0	40	30	4MXT
-5	8	5/16	0.60	15.2	5500	38.0	22000	152.0	45	33	5MXT
-6	10	3/8	0.68	17.1	4800	33.0	19200	132.0	65	39	6MXT
-8	12	1/2	0.80	20.2	4000	28.0	16000	112.0	70	46	8MXT
-10	16	5/8	0.95	24.0	3625	25.0	14500	100.0	75	57	10MXT
-12	19	3/4	1.08	27.4	3100	21.5	12400	86.0	120	70	12MXT
-16	25	1	1.38	35.1	2400	16.5	9600	66.0	150	100	16MXT

RECOMMENDED FOR

High pressure hydraulic applications. Easy to route and install in tight areas. Cross-functional and multi-spec hydraulic solution.

TUBE

NBR (Nitrile) based.

REINFORCEMENT

Braided high-tensile steel wire.

COVER

NBR/PVC based. MSHA approved.

TEMPERATURE RANGE

-40°C to +100°C. For water emulsions, etc. see Engineering and technical data page 292.

STANDARDS

Exceeds SAE 100R 16, ISO 11237 R16 and ISO 11237 R17 (-4 to -12).
Exceeds EN 853 2SN and EN 857 2SC performance.
Exceeds ISO 1436 R2 and ISO 11237 R19 (-4 to -8) performance.

COUPLINGS

MegaCrimp™.

CHARACTERISTICS/BENEFITS

- Superior flex impulse performance: tested to 600,000 impulse cycles, which is 3 times the impulse criteria.
- Lower force-to-bend for faster and more ergonomic installation.
- Lightweight for easier handling and reduced equipment weight.
- MXT hose is compatible with biodegradable hydraulic fluids like synthetic esters, polyglycols and vegetable oils as well as petroleum-based fluids.
- Patented construction.



MXT XTRATUFF™ PLUS COVER

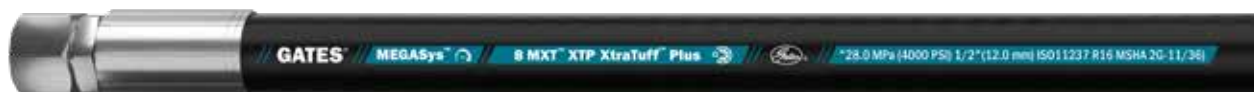

-size	↻		⊘		⊙		🌿		⤵	⚖	📏
	DN	"	"	mm	PSI	MPa	PSI	MPa	mm	kg/100m	REF.
-4	6	1/4	0.56	14.0	6000	42.0	24000	168.0	40	30	4MXT-XTP
-5	8	5/16	0.60	15.2	5500	38.0	22000	152.0	45	33	5MXT-XTP
-6	10	3/8	0.68	17.1	4800	33.0	19200	132.0	65	39	6MXT-XTP
-8	12	1/2	0.80	20.2	4000	28.0	16000	112.0	70	46	8MXT-XTP
-10	16	5/8	0.95	24.0	3625	25.0	14500	100.0	100	57	10MXT-XTP
-12	19	3/4	1.08	27.4	3100	21.5	12400	86.0	120	70	12MXT-XTP
-16	25	1	1.38	35.1	2400	16.5	9600	66.0	150	100	16MXT-XTP

- RECOMMENDED FOR** High pressure hydraulic applications. Easy to route and install in tight areas. Multi-spec hydraulic solution with improved ozone and abrasion resistance.
- TUBE** NBR (Nitrile) based.
- REINFORCEMENT** Braided high-tensile steel wire.
- COVER** Gates proprietary. MSHA approved.
- TEMPERATURE RANGE** -40°C to +100°C. For water emulsions, etc. see Engineering and technical data page 292.
- STANDARDS** Exceeds SAE 100R 16, ISO 11237 R16 and ISO 11237 R17 (-4 to -12).
Exceeds EN 853 2SN and EN 857 2SC performance.
Exceeds ISO 1436 R2 and ISO 11237 R19 (-4 to -8) performance.
- COUPLINGS** MegaCrimp™.
- CHARACTERISTICS/BENEFITS**
 - Superior flex impulse performance: tested to 600,000 impulse cycles, which is 3 times the impulse criteria of EN 857 2SC.
 - Lower force-to-bend for faster and more ergonomic installation.
 - Lightweight for easier handling and reduced equipment weight.
 - MXT-XTP hose is compatible with biodegradable hydraulic fluids like synthetic esters, polyglycols and vegetable oils as well as petroleum-based fluids.
 - Enhanced ozone & abrasion resistance.

TABLE OF CONTENTS

ABOUT GATES

HYDRAULIC HOSE

HYDRAULIC HOSE COUPLINGS

ENGINEERING AND TECHNICAL DATA

CM2TDL XTRATUFF™ COVER

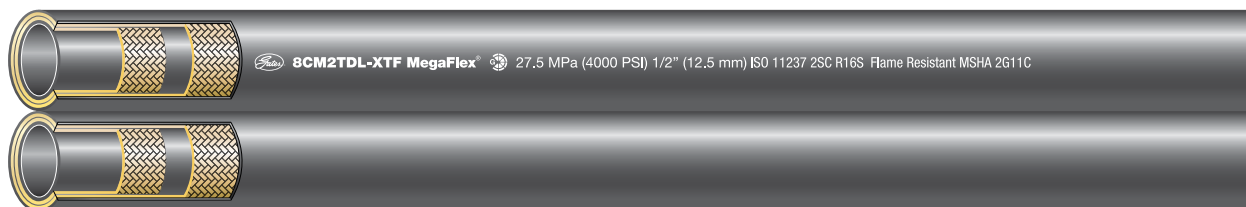

-size	↔		⊘		⊙		🔥		📏		REF.
	DN	"	"	mm	PSI	MPa	PSI	MPa	mm	kg/100m	
-6	10	3/8	0.70	17.7	4800	33.0	19200	132.0	65	86	6CM2TDL-XTF
-8	12	1/2	0.82	20.8	4000	27.5	16000	110.0	90	104	8CM2TDL-XTF

- RECOMMENDED FOR** High pressure and return lines such as boom arm and forklift applications.
- TUBE** NBR (Nitrile) based.
- REINFORCEMENT** Two braids of high tensile steel wire.
- COVER** NBR (Nitrile) based. MSHA approved.
- TEMPERATURE RANGE** -40°C to +100°C. For water emulsions, etc. see Engineering and technical data page 292.
- STANDARDS** Exceeds ISO 11237 2SC R16S. EN 857 2SC. SAE 100R16.
- COUPLINGS** MegaCrimp™.
- CHARACTERISTICS/BENEFITS**
- 70% of EN 857 2SC bend radius at rated working pressure.
 - Superior flex impulse performance.
 - Lightweight.
 - CM2T - Twin hose is compatible with biodegradable hydraulic fluids like synthetic esters, polyglycols and vegetable oils as well as petroleum-based fluids.
 - No need to use clamps as the two lines are vulcanised together to form one single unit.
 - Gates special XtraTuff™ cover which offers 25 times the abrasion resistance of the standard CM2T cover as per ISO 6945.
- IMPORTANT**
- Gates recommends minimum split length of 250 mm depending on the application. Do not expose hose reinforcement when splitting hoses.



G2

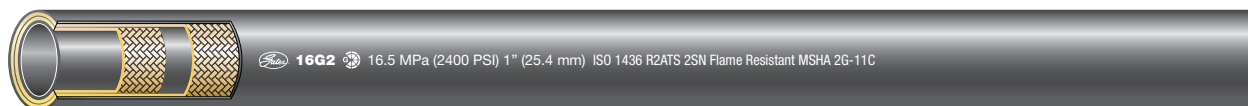

-size	DN		mm		PSI		MPa		mm	kg/100m	REF.
	DN	"	"	mm	PSI	MPa	PSI	MPa			
-4	6	1/4	0.58	15.0	5800	40.0	23200	160.0	50	35	4G2
-5	8	5/16	0.64	16.3	5000	35.0	20000	140.0	55	39	5G2
-6	10	3/8	0.73	18.8	4800	33.0	19200	132.0	65	51	6G2
-8	12	1/2	0.86	21.8	4000	27.5	16000	112.0	90	61	8G2
-10	16	5/8	0.98	25.1	3625	25.0	14500	100.0	100	73	10G2
-12	19	3/4	1.14	29.0	3100	21.5	12400	86.0	120	91	12G2
-16	25	1	1.48	37.6	2400	16.5	9600	66.0	150	129	16G2
-20	31	1.1/4	1.87	47.5	1825	12.5	7300	50.0	210	225	20G2
-24	38	1.1/2	2.15	54.6	1300	9.0	5200	36.0	250	263	24G2
-32	51	2	2.65	67.3	1175	8.0	4700	32.0	315	335	32G2

- RECOMMENDED FOR** High pressure hydraulic applications.
- TUBE** NBR (Nitrile) based.
- REINFORCEMENT** Two braids of high tensile steel wire.
- COVER** NBR/PVC based. MSHA approved.
- TEMPERATURE RANGE** -40°C to +100°C. For water emulsions, etc. see Engineering and technical data page 292.
- STANDARDS** Exceeds ISO 1436 2SN R2ATS. EN 853 2SN. SAE 100R2AT.
- COUPLINGS** -4 to -20: MegaCrimp™; -24, -32: GlobalSpiral Plus.
- TYPE APPROVALS** DNV, GL, LR, BV and ABS.
- CHARACTERISTICS/BENEFITS**
 - 50% of SAE 100R2 bend radius at rated working pressure.
 - Superior flex impulse performance: tested to 600,000 impulse cycles.
 - G2 hose is compatible with biodegradable hydraulic fluids like synthetic esters, polyglycols and vegetable oils as well as petroleum-based fluids.



- OPTIONAL**
 -  G2XH: For high-temperature applications, Gates recommends the G2XH hose range up to +150°C constant.
 -  G2L: for low-temperature applications, Gates recommends the G2L range down to -57°C constant.

TABLE OF CONTENTS

ABOUT GATES

HYDRAULIC HOSE

HYDRAULIC HOSE COUPLINGS

ENGINEERING AND TECHNICAL DATA

MEGASYS™ WIRE AND TEXTILE BRAID HYDRAULIC HOSE

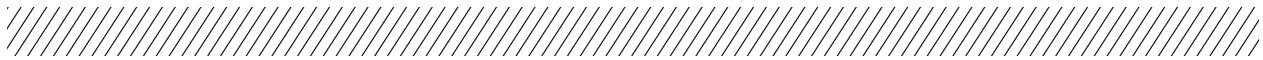

G1

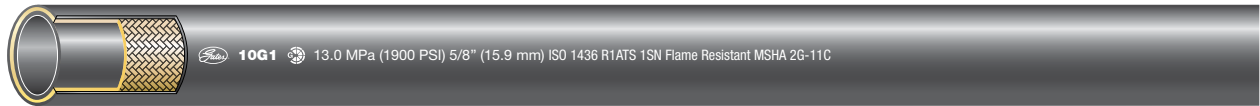

-size											REF.
	DN	"	"	mm	PSI	MPa	PSI	MPa	mm	kg/100m	
-4	6	1/4	0.53	13.5	3250	22.5	13000	90.0	50	22	4G1
-5	8	5/16	0.59	15.1	3100	21.5	12400	86.0	55	26	5G1
-6	10	3/8	0.69	17.1	2600	18.0	10400	72.0	65	32	6G1
-8	12	1/2	0.82	20.3	2325	16.0	9300	64.0	90	39	8G1
-10	16	5/8	0.94	23.5	1900	13.0	7600	52.0	100	46	10G1
-12	19	3/4	1.10	27.6	1525	10.5	6100	42.0	120	59	12G1
-16	25	1	1.41	35.4	1275	9.0	5100	36.0	150	84	16G1
-20	31	1.1/4	1.71	43.4	925	6.4	3700	25.6	210	128	20G1
-24	38	1.1/2	1.96	49.8	725	5.0	2900	20.0	250	145	24G1
-32	51	2	2.52	64.0	600	4.2	2400	16.8	315	205	32G1

RECOMMENDED FOR

Medium pressure hydraulic applications.

TUBE

NBR (Nitrile) based.

REINFORCEMENT

One braid of high tensile steel wire.

COVER

NBR/PVC based. MSHA approved.

TEMPERATURE RANGE

-40°C to +100°C. For water emulsions, etc. see Engineering and technical data page 292.

STANDARDS

Exceeds ISO 1436 1SN R1ATS. EN 853 1SN. SAE 100R1AT.

COUPLINGS

-4 to -20: MegaCrimp™; -24, -32: GlobalSpiral Plus.

TYPE APPROVALS

DNV, GL, LR, BV and ABS.

CHARACTERISTICS/BENEFITS

- 50% of SAE 100R1 bend radius at rated working pressure.
- Superior flex impulse performance: tested to 600,000 impulse cycles.
- G1 hose is compatible with biodegradable hydraulic fluids like synthetic esters, polyglycols and vegetable oils as well as petroleum-based fluids.

OPTIONAL



G1H: For high-temperature applications, Gates recommends the G1H hose range up to +135°C constant.

MEGASYS™ WIRE AND TEXTILE BRAID HYDRAULIC HOSE



TH8

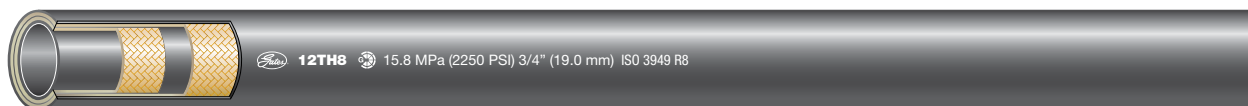

-size	DN		mm		PSI		MPa		mm	kg/100m	REF.
	DN	"	"	mm	PSI	MPa	PSI	MPa			
-4	6	1/4	0.61	15.5	5000	35.0	20000	140	50	18	4TH8
-6	10	3/8	0.75	19.1	4000	28.0	16000	112	65	31	6TH8
-8	12	1/2	0.87	22.1	3500	24.5	14000	98.0	100	34	8TH8
-12	19	3/4	1.13	28.7	2250	15.8	9000	63.2	165	38	12TH8
-16	25	1	1.45	36.8	2000	14.0	8000	56.0	250	57	16TH8

- RECOMMENDED FOR** High pressure hydraulic applications, especially material handling equipment with mast and pulley systems like forklifts, aerial lifting, hydraulic boom cranes and many others.
- TUBE** PA (Nylon) based.
- REINFORCEMENT** Two fibre braids.
- COVER** PU (Polyurethane) based. Black TH8 is perforated for use in general hydraulic and pneumatic service.
- TEMPERATURE RANGE** -53 °C to +93 °C. For water emulsions, etc. see Engineering and technical data page 292.
- STANDARDS** Exceeds ISO 3949 R8. EN 855 R8. SAE 100R8.
- COUPLINGS** MegaCrimp™.
- OPTIONAL**  TH8NC: Sizes -04, -06 and -08 are also available in a non-conductive version. TH8NC has an orange polyurethane cover and is non-perforated for applications requiring electrical non-conductivity. TH8NC meets the SAE 100R8 Electrical Conductivity Test.

TABLE OF CONTENTS

ABOUT GATES

HYDRAULIC HOSE

HYDRAULIC HOSE COUPLINGS

ENGINEERING AND TECHNICAL DATA

MEGASYS™ WIRE AND TEXTILE BRAID HYDRAULIC HOSE



TH7

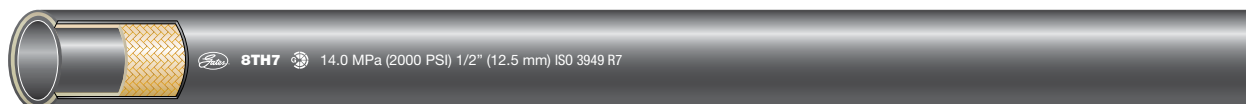

-size											
	DN	"	"	mm	PSI	MPa	PSI	MPa	mm	kg/100m	REF.
-3	5	3/16	0.41	10.4	3000	20.7	12000	82.7	20	8	3TH7S
-4	6	1/4	0.50	12.7	2750	19.2	11000	76.8	30	8	4TH7S
-5	8	5/16	0.56	14.7	2500	17.5	10000	70.0	45	10	5TH7S
-6	10	3/8	0.64	16.4	2250	15.8	9000	63.2	50	14	6TH7S
-8	12	1/2	0.80	20.3	2000	14.0	8000	56.0	75	21	8TH7S
-12	19	3/4	1.05	26.6	1250	8.7	5000	34.8	130	29	12TH7
-16	25	1	1.32	33.4	1000	7.0	4000	28.0	250	40	16TH7

RECOMMENDED FOR

High pressure hydraulic applications, especially material handling equipment with mast and pulley systems like forklifts, aerial lifting, hydraulic boom cranes and many others.

TUBE

PA (Nylon) based.

REINFORCEMENT

-4 to -6: spiralled synthetic fibre; -8 to -12: one fibre braid.

COVER

PU (Polyurethane) based. Black TH7 is perforated for use in general hydraulic and pneumatic service.

TEMPERATURE RANGE

-53°C to +93°C. For water emulsions, etc. see Engineering and technical data page 292.

STANDARDS

Exceeds ISO 3949 R7. EN 855 R7. SAE 100R7.

COUPLINGS

MegaCrimp™.

OPTIONAL



TH7NC: The complete range (-4 up to -16) is also available in a non-conductive version. TH7NC has an orange polyurethane cover and is non-perforated for applications requiring electrical non-conductivity. TH7NC meets the SAE 100R7 Electrical Conductivity Test.

TABLE OF CONTENTS

ABOUT GATES

HYDRAULIC HOSE

HYDRAULIC HOSE
COUPLINGS

ENGINEERING AND
TECHNICAL DATA



TH7DL

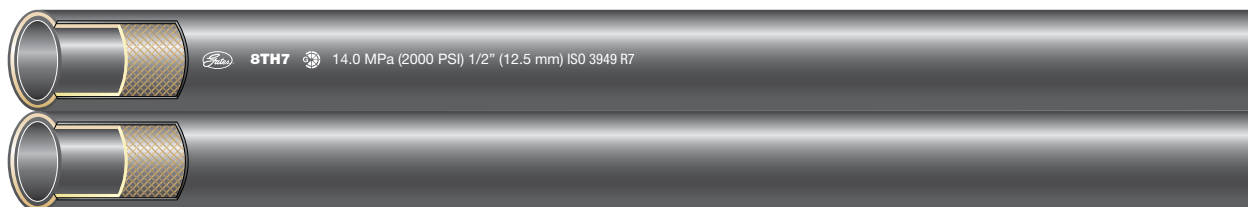

-size	↔		○		⌚		🌀		🔧		🏋️	📏
	DN	"	"	mm	PSI	MPa	PSI	MPa	mm	kg/100m	REF.	
-4	6	1/4	0.50	12.7	2750	19.2	11000	76.8	30	17	4TH7DL	
-5	8	5/16	0.56	14.7	2500	17.5	10000	70.0	45	21	5TH7DL	
-6	10	3/8	0.64	16.4	2250	15.8	9000	63.2	50	28	6TH7DL	
-8	12	1/2	0.80	20.3	2000	14.0	8000	56.0	75	42	8TH7DL	

RECOMMENDED FOR	High pressure hydraulic applications, especially material handling equipment with mast and pulley systems like forklifts, aerial lifting, hydraulic boom cranes and many others.
TUBE	PA (Nylon) based.
REINFORCEMENT	-4 to -6: spiralled synthetic fibre; -8 to -12: one fibre braid.
COVER	PU (Polyurethane) based. Black TH7DL is perforated for use in general hydraulic and pneumatic service.
TEMPERATURE RANGE	-53°C to +93°C. For water emulsions, etc. see Engineering and technical data page 292.
STANDARDS	Exceeds ISO 3949 R7. EN 855 R7. SAE 100R7.
COUPLINGS	MegaCrimp™.
OPTIONAL	 TH7DLNC: Sizes -04, -06 and -08 are also available in a non-conductive version. TH7DLNC has an orange polyurethane cover and is non-perforated for applications requiring electrical non-conductivity. TH7DLNC meets the SAE 100R7 Electrical Conductivity Test.

TABLE OF CONTENTS

ABOUT GATES

HYDRAULIC HOSE

HYDRAULIC HOSE COUPLINGS

ENGINEERING AND TECHNICAL DATA

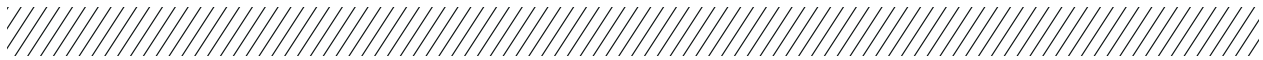

PILOT

CONSTANT PRESSURE

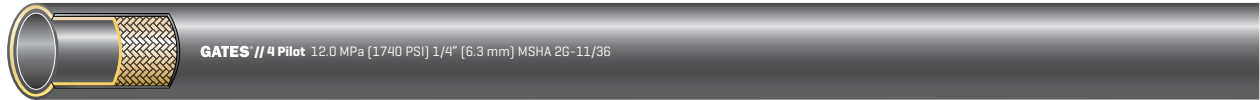

-size											REF.
	DN	"	"	mm	PSI	MPa	PSI	MPa	mm	kg/100m	
-3	5	3/16	0.37	9.3	1740	12.0	6960	48.0	20	9	3 Pilot
-4	6	1/4	0.44	11.2	1740	12.0	6960	48.0	25	14	4 Pilot
-5	8	5/16	0.54	13.6	1740	12.0	6960	48.0	30	21	5 Pilot
-6	10	3/8	0.63	15.9	1740	12.0	6960	48.0	45	23	6 Pilot

RECOMMENDED FOR

Hydraulic pilot control applications in confined spaces in industrial, construction and agricultural equipment, designed for superior signal response.

TUBE

NBR (Nitrile).

REINFORCEMENT

One braid of high tensile steel wire.

COVER

NBR/PVC based. MSHA approved.

TEMPERATURE RANGE

-40°C to +100°C. For water emulsions, etc.

STANDARDS

Gates proprietary.

COUPLINGS

P1T.

CHARACTERISTICS/BENEFITS

- Very high flexibility, lightweight and extremely tight bend radii. Superior resistance to kinking.
- Developed for high hose-to-hose abrasion resistance.
- Tested to 1 million impulse cycles.
- Superior signal response through minimal expansion under pressure.

IMPORTANT



PILOT use the ferrules indicated in below table.

SIZE	P1T Ferrule
-3	3MP1F-1
-4	4MP1F-1
-5	5MP1F-1
-6	6MP1F-1

MEGASYS™ WIRE AND TEXTILE BRAID HYDRAULIC HOSE



M4KH

CONSTANT PRESSURE

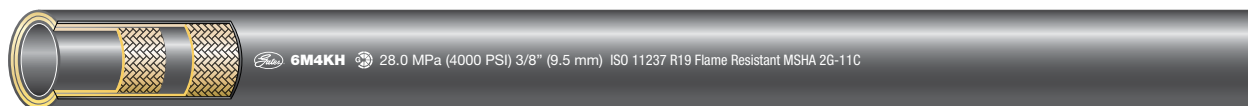

-size	DN		mm		PSI		MPa		mm	kg/100m	REF.
	DN	"	"	mm	PSI	MPa	PSI	MPa			
-4	6	1/4	0.54	13.7	4000	28.0	16000	112.0	50	33	4M4KH
-6	10	3/8	0.70	17.5	4000	28.0	16000	112.0	65	46	6M4KH
-8	12	1/2	0.82	20.8	4000	28.0	16000	112.0	90	57	8M4KH
-10	16	5/8	0.98	25.0	4000	28.0	16000	112.0	100	82	10M4KH
-12	19	3/4	1.17	29.6	4000	28.0	16000	112.0	120	109	12M4KH

- RECOMMENDED FOR** High pressure hydraulic applications. Easy to route and to install in tight areas.
- TUBE** NBR (Nitrile) based.
- REINFORCEMENT** Two braids of high tensile steel wire.
- COVER** CR (Chloroprene) based. MSHA approved.
- TEMPERATURE RANGE** -40°C to +121°C. For water emulsions, etc. see Engineering and technical data page 292.
- STANDARDS** Exceeds ISO 11237 R19. SAE 100R19.
Meets or exceeds EN 857 2SC performance requirements.
- COUPLINGS** MegaCrimp™.
- CHARACTERISTICS/BENEFITS**
 - 70% of EN 857 2SC and 50% of EN 853 2SN bend radius at rated working pressure.
 - Alternative to spiral hoses in high pressure lines where flexibility is required.
 - Superior flex impulse performance: tested to 600,000 impulse cycles.
 - Lightweight.
 - M4KH hose is compatible with biodegradable hydraulic fluids like synthetic esters, polyglycols and vegetable oils as well as petroleum-based fluids.

TABLE OF CONTENTS

ABOUT GATES

HYDRAULIC HOSE

HYDRAULIC HOSE COUPLINGS

ENGINEERING AND TECHNICAL DATA

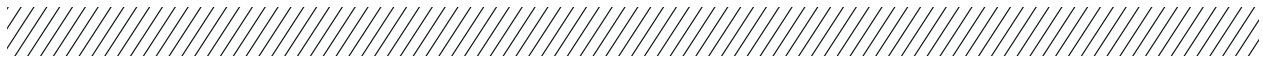

M4KH MEGATUFF™ COVER

CONSTANT PRESSURE

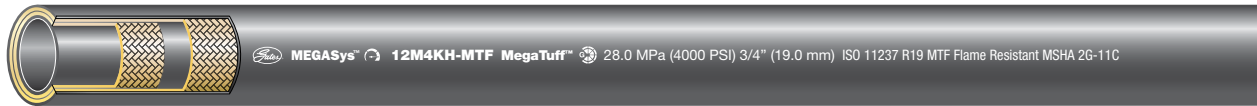

-size	↻		⊘		⊙		🔥		👂		🏋️	📏
	DN	"	"	mm	PSI	MPa	PSI	MPa	mm	kg/100m	REF.	
-10	16	5/8	0.98	25.0	4000	28.0	16000	112.0	100	82	10M4KH-MTF	
-12	19	3/4	1.17	29.6	4000	28.0	16000	112.0	120	109	12M4KH-MTF	

RECOMMENDED FOR

High pressure hydraulic applications. Easy to route and to install in tight areas.

TUBE

NBR (Nitrile) based.

REINFORCEMENT

Two braids of high tensile steel wire.

COVER

CR (Chloroprene) based. MSHA approved.

TEMPERATURE RANGE

-40°C to +121°C. For water emulsions, etc. see Engineering and technical data page 292.

STANDARDS

Exceeds ISO 11237 R19. SAE 100R19.
Meets or exceeds EN 857 2SC performance requirements.

COUPLINGS

MegaCrimp™.

CHARACTERISTICS/BENEFITS

- 70% of EN 857 2SC and 50% of EN 853 2SN bend radius at rated working pressure.
- Alternative to spiral hoses in high pressure lines where flexibility is required.
- Superior flex impulse performance: tested to 600,000 impulse cycles.
- Lightweight.
- M4KH-MTF hose is compatible with biodegradable hydraulic fluids like synthetic esters, polyglycols and vegetable oils as well as petroleum-based fluids.
- Gates special MegaTuff cover offers 300 times the abrasion resistance of the standard M4KH cover as per ISO 6945, superior ozone and weathering resistance.

IMPORTANT



Please consult Gates' Product Application Engineers for use of MegaTuff™ hose in reverse bending applications.

MEGASYS™ WIRE AND TEXTILE BRAID HYDRAULIC HOSE



M4KL

CONSTANT PRESSURE

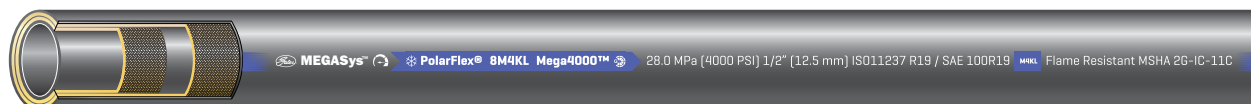

-size	DN		mm		PSI		MPa		mm	kg/100m	REF.
	DN	"	"	mm	PSI	MPa	PSI	MPa			
-4	6	1/4	0.54	14.0	4000	28.0	16000	112.0	50	30	4M4KL
-5	8	5/16	0.60	15.2	4000	28.0	16000	112.0	55	34	5M4KL
-6	10	3/8	0.69	17.7	4000	28.0	16000	112.0	65	43	6M4KL
-8	12	1/2	0.82	20.7	4000	28.0	16000	112.0	90	52	8M4KL
-10	16	5/8	0.98	25.0	4000	28.0	16000	112.0	100	73	10M4KL
-12	19	3/4	1.16	29.6	4000	28.0	16000	112.0	120	100	12M4KL

RECOMMENDED FOR	High pressure hydraulic applications at extremely low temperatures. Easy to route and to install in tight areas.
TUBE	NBR (Nitrile) based.
REINFORCEMENT	Two braids of high tensile wire.
COVER	NBR/PVC based. MSHA approved.
TEMPERATURE RANGE	-57°C to +100°C. For water emulsions, etc. see Engineering and technical data page 292.
STANDARDS	Exceeds ISO 11237 R19. SAE 100R19. Meets or exceeds EN 857 2SC and EN 853 2SN performance requirements.
COUPLINGS	MegaCrimp™.
CHARACTERISTICS/BENEFITS	<ul style="list-style-type: none"> ■ 70% of EN 857 2SC and 50% of EN 853 2SN bend radius at rated working pressure. ■ Alternative to spiral hoses in high pressure lines where flexibility is required. ■ Lightweight. ■ M4KL hose is compatible with biodegradable hydraulic fluids like synthetic esters, polyglycols and vegetable oils as well as petroleum-based fluids.

TABLE OF CONTENTS

ABOUT GATES

HYDRAULIC HOSE

HYDRAULIC HOSE COUPLINGS

ENGINEERING AND TECHNICAL DATA

MEGASYS™ WIRE AND TEXTILE BRAID HYDRAULIC HOSE



M3KH

CONSTANT PRESSURE

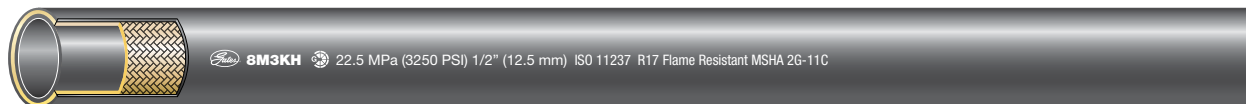

-size	↻		⊘		⊙		🔥		👉		🏋️	📏
	DN	"	"	mm	PSI	MPa	PSI	MPa	mm	kg/100m	REF.	
-4	6	1/4	0.48	12.2	3250	22.5	13000	90.0	50	19	4M3KH	
-5	8	5/16	0.60	15.1	3250	22.5	13000	90.0	55	26	5M3KH	
-6	10	3/8	0.65	16.0	3250	22.5	13000	90.0	65	31	6M3KH	
-8	12	1/2	0.80	20.2	3250	22.5	13000	90.0	90	41	8M3KH	
-10	16	5/8	0.99	25.2	3250	22.5	13000	90.0	100	73	10M3KH	
-12	19	3/4	1.14	29.0	3250	22.5	13000	90.0	120	91	12M3KH	
-16	25	1	1.48	37.7	3250	22.5	13000	90.0	150	155	16M3KH	

RECOMMENDED FOR

High pressure hydraulic applications. Easy to route and to install in tight areas.

TUBE

NBR (Nitrile) based.

REINFORCEMENT

-4 to -8: one braid of high tensile steel wire; -10 to -16: two braids of high tensile steel wire.

COVER

CR (Chloroprene) based. MSHA approved.

TEMPERATURE RANGE

-40°C to +121°C. For water emulsions, etc. see Engineering and technical data page 292.

STANDARDS

Exceeds ISO 11237 R17. SAE 100R17.
Meets or exceeds EN 857 1SC/2SC performance requirements.

COUPLINGS

MegaCrimp™.

CHARACTERISTICS/BENEFITS

- 70% of EN 857 2SC and 50% of EN 853 2SN bend radius at rated working pressure.
- Alternative to spiral hoses in high pressure lines where flexibility is required.
- Superior flex impulse performance: tested to 600,000 impulse cycles.
- Lightweight.
- M3KH hose is compatible with biodegradable hydraulic fluids like synthetic esters, polyglycols and vegetable oils as well as petroleum-based fluids.



M3KH MEGATUFF™ COVER

CONSTANT PRESSURE

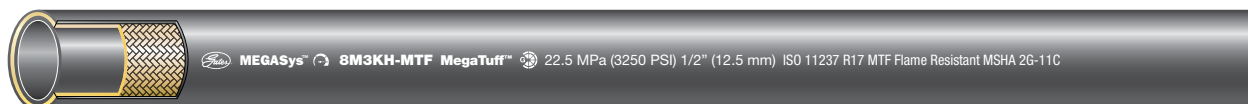

-size	↻		⊘		⊙		🌿		⤴	⚖	📏
	DN	"	"	mm	PSI	MPa	PSI	MPa	mm	kg/100m	REF.
-4	6	1/4	0.48	12.2	3250	22.5	13000	90.0	50	19	4M3KH-MTF
-6	10	3/8	0.65	16.0	3250	22.5	13000	90.0	65	31	6M3KH-MTF
-8	12	1/2	0.80	20.2	3250	22.5	13000	90.0	90	41	8M3KH-MTF
-10	16	5/8	0.99	25.2	3250	22.5	13000	90.0	100	73	10M3KH-MTF
-12	19	3/4	1.15	29.0	3250	22.5	13000	90.0	120	91	12M3KH-MTF
-16	25	1	1.48	37.7	3250	22.5	13000	90.0	150	155	16M3KH-MTF

- RECOMMENDED FOR** High pressure hydraulic applications. Easy to route and to install in tight areas.
- TUBE** NBR (Nitrile) based.
- REINFORCEMENT** -4 to -8: one braid of high tensile steel wire; -10 to -16: two braids of high tensile steel wire.
- COVER** CR (Chloroprene) based. MSHA approved.
- TEMPERATURE RANGE** -40°C to +121°C. For water emulsions, etc. see Engineering and technical data page 292.
- STANDARDS** Exceeds ISO 11237 R17. SAE 100R17.
Meets or exceeds EN 857 1SC/2SC performance requirements.
- COUPLINGS** MegaCrimp™.
- CHARACTERISTICS/BENEFITS**
- 70% of EN 857 2SC and 50% of EN 853 2SN bend radius at rated working pressure.
 - Alternative to spiral hoses in high pressure lines where flexibility is required.
 - Superior flex impulse performance: tested to 600,000 impulse cycles.
 - Lightweight.
 - M3KH-MTF hose is compatible with biodegradable hydraulic fluids like synthetic esters, polyglycols and vegetable oils as well as petroleum-based fluids.
 - Gates special MegaTuff cover offers 300 times the abrasion resistance of the standard M3KH cover as per ISO 6945, superior ozone and weathering resistance.

IMPORTANT



Please consult Gates' Product Application Engineers for use of MegaTuff™ hose in reverse bending applications.

TABLE OF CONTENTS

ABOUT GATES

HYDRAULIC HOSE

HYDRAULIC HOSE COUPLINGS

ENGINEERING AND TECHNICAL DATA

G2XH



-size									mm	kg/100m	REF.
	DN	"	"	mm	PSI	MPa	PSI	MPa			
-4	6	1/4	0.59	14.9	6000	42.0	24000	168.0	100	42	4G2XH
-6	10	3/8	0.74	18.8	5000	35.0	20000	132.0	130	54	6G2XH
-8	12	1/2	0.86	21.8	4250	29.0	17000	116.0	180	65	8G2XH
-10	16	5/8	0.99	25.1	3625	25.0	14500	100.0	200	77	10G2XH
-12	19	3/4	1.15	29.1	3100	21.5	12400	86.0	240	94	12G2XH
-16	25	1	1.48	37.6	2500	17.5	10000	70.0	300	141	16G2XH
-20	31	1.1/4	1.86	47.2	2250	15.5	9000	62.0	420	212	20G2XH
-24	38	1.1/2	2.15	54.6	1800	12.4	6000	42.0	500	207	24G2XH
-32	51	2	2.65	67.3	1500	10.3	5200	35.9	630	293	32G2XH

- RECOMMENDED FOR TUBE** High-temperature, high pressure hydraulic applications such as engine compartments, foundries, ...
CPE (Chlorinated polyethylene) based.
- REINFORCEMENT** Two braids of high tensile steel wire.
- COVER** CSM (Chlorosulfonated polyethylene) based. Blue. MSHA approved.
- TEMPERATURE RANGE** -40°C to +150°C. For water emulsions, etc. see Engineering and technical data page 292.
- STANDARDS** Exceeds ISO 1436 2SN R2ATS. EN 853 2SN. SAE 100R2AT.
- COUPLINGS** -4 to -20: MegaCrimp™; -24 to -32: GlobalSpiral Plus.
- CHARACTERISTICS/BENEFITS**
- Superior flex impulse performance: tested to 600,000 impulse cycles.
 - G2XH hose is compatible with biodegradable hydraulic fluids like synthetic esters, polyglycols and vegetable oils as well as petroleum-based fluids and phosphate esters.



G2H



-size	↻		⊘		⊘		🌸		⤴		⚖	📏
	DN	"	"	mm	PSI	MPa	PSI	MPa	mm	kg/100m	REF.	
-20	31	1.1/4	1.87	47.5	1825	12.5	7300	50.0	420	226	20G2H	
-24	38	1.1/2	2.15	54.6	1300	9.0	5200	36.0	500	248	24G2H	
-32	51	2	2.62	67.3	1175	8.0	4700	32.0	630	315	32G2H	

RECOMMENDED FOR High-temperature, high pressure hydraulic applications such as engine compartments, foundries, ...

TUBE NBR (Nitrile) based.

REINFORCEMENT Two braids of high tensile steel wire.

COVER CSM (Chlorosulfinated polyethylene) based. MSHA approved.

TEMPERATURE RANGE -40°C to +135°C constant and +150°C intermittent.
For water emulsions, etc. see Engineering and technical data page 292.

STANDARDS Meets ISO 1436 2SN R2ATS / EN 853 2SN. Exceeds SAE 100R2AT.

COUPLINGS -20: MegaCrimp™; -24 to -32: GlobalSpiral Plus.

- CHARACTERISTICS/BENEFITS**
- Superior flex impulse performance: tested to 600,000 impulse cycles.
 - G2H hose is compatible with biodegradable hydraulic fluids like synthetic esters, polyglycols and vegetable oils as well as petroleum-based fluids.

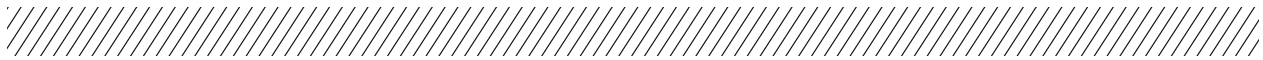

G2H MEGATUFF™ COVER

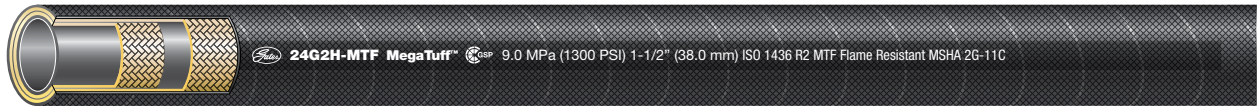

-size											REF.
	DN	"	"	mm	PSI	MPa	PSI	MPa	mm	kg/100m	
-20	31	1.1/4	1.87	47.5	1825	12.5	7300	50.0	420	226	20G2H-MTF
-24	38	1.1/2	2.15	54.6	1300	9.0	5200	36.0	500	248	24G2H-MTF
-32	51	2	2.65	67.3	1175	8.0	4700	32.0	630	315	32G2H-MTF

RECOMMENDED FOR High-temperature, high pressure hydraulic applications such as engine compartments, foundries, ...

TUBE NBR (Nitrile) based.

REINFORCEMENT Two braids of high tensile steel wire.

COVER CSM (Chlorosulfonated polyethylene) based. MSHA approved.

TEMPERATURE RANGE -40°C to +135°C constant and +150°C intermittent.
For water emulsions, etc. see Engineering and technical data page 292.

STANDARDS Meets ISO 1436 2SN R2ATS / EN 853 2SN. Exceeds SAE 100R2AT.

COUPLINGS -20: MegaCrimp™; -24 to -32: GlobalSpiral Plus.

CHARACTERISTICS/BENEFITS

- Superior flex impulse performance: tested to 600,000 impulse cycles.
- G2H-MTF hose is compatible with biodegradable hydraulic fluids like synthetic esters, polyglycols and vegetable oils as well as petroleum-based fluids.
- Gates special MegaTuff cover offers 300 times the abrasion resistance of the standard G2H cover as per ISO 6945, superior ozone and weathering resistance.

IMPORTANT  Please consult Gates' Product Application Engineers for use of MegaTuff™ hose in reverse bending applications.



G2L



-size	↻		⊘		⊙		🌸		⤴	⚖	📏
	DN	"	"	mm	PSI	MPa	PSI	MPa	mm	kg/100m	REF.
-4	6	1/4	0.59	15.0	5800	40.0	23200	160.0	100	36	4G2L
-6	10	3/8	0.74	18.8	4800	33.0	19200	132.0	130	53	6G2L
-8	12	1/2	0.86	21.8	4000	27.5	16000	112.0	180	64	8G2L
-10	16	5/8	0.99	25.1	3625	25.0	14500	100.0	200	76	10G2L
-12	19	3/4	1.14	29.0	3100	21.5	12400	86.0	240	91	12G2L
-16	25	1	1.48	37.6	2400	16.5	9600	66.0	300	136	16G2L
-20	31	1.1/4	1.87	47.5	1825	12.5	7300	50.0	420	212	20G2L
-24	38	1.1/2	2.12	53.8	1300	9.0	5200	36.0	500	223	24G2L
-32	51	2	2.62	66.5	1175	8.0	4700	32.0	630	319	32G2L

- RECOMMENDED FOR** High pressure hydraulic applications at extremely low temperatures.
- TUBE** NBR (Nitrile) based.
- REINFORCEMENT** Two braids of high tensile steel wire.
- COVER** CR (Chloroprene) based. MSHA approved.
- TEMPERATURE RANGE** -57°C to +100°C. For water emulsions, etc. see Engineering and technical data page 292.
- STANDARDS** Exceeds ISO 1436 2SN R2ATS. EN 853 2SN. SAE 100R2AT.
- COUPLINGS** -4 to -20: MegaCrimp™; -24 to -32: GlobalSpiral Plus.
- CHARACTERISTICS/BENEFITS**
 - Unique low temperature tube for extended service life at extremely low temperatures.
 - Superior flex impulse performance: tested to 600,000 impulse cycles.
 - G2L hose is compatible with biodegradable hydraulic fluids like synthetic esters, polyglycols and vegetable oils as well as petroleum-based fluids.

TABLE OF CONTENTS

ABOUT GATES

HYDRAULIC HOSE

HYDRAULIC HOSE COUPLINGS

ENGINEERING AND TECHNICAL DATA



G1H



-size									mm	kg/100m	REF.
	DN	"	"	mm	PSI	MPa	PSI	MPa			
-4	6	1/4	0.53	13.5	2750	19.0	11000	76.8	50	22	4G1H
-6	10	3/8	0.69	17.1	2250	15.5	9000	62.8	65	35	6G1H
-8	12	1/2	0.80	20.3	2000	13.8	8000	56.0	90	43	8G1H
-10	16	5/8	0.94	23.5	1500	10.3	6000	42.0	100	49	10G1H
-12	19	3/4	1.10	27.6	1250	8.6	5000	35.8	120	64	12G1H
-16	25	1	1.41	35.4	1000	6.9	4000	28.0	150	91	16G1H
-20	31	1.1/4	1.72	43.7	925	6.4	3700	25.6	210	128	20G1H
-24	38	1.1/2	1.96	49.8	725	5.0	2900	20.0	250	146	24G1H
-32	51	2	2.52	64.0	600	4.2	2400	16.8	315	207	32G1H

- RECOMMENDED FOR** High-temperature, medium pressure hydraulic applications such as engine compartments, foundries, ...
- TUBE** NBR (Nitrile) based.
- REINFORCEMENT** One braid of high tensile steel wire.
- COVER** CSM (Chlorosulfonated polyethylene) based. MSHA approved.
- TEMPERATURE RANGE** -40°C to +135°C constant and +150°C intermittent.
For water emulsions, etc. see Engineering and technical data page 292.
- STANDARDS** SAE 100R1.
- COUPLINGS** -4 to -20: MegaCrimp™; -24 to -32: GlobalSpiral Plus.
- CHARACTERISTICS/BENEFITS**
- 50% of SAE 100R1 bend radius at rated working pressure.
 - Superior flex impulse performance: tested to 600,000 impulse cycles.

MEGASYS™ WIRE AND TEXTILE BRAID HYDRAULIC HOSE



G3H

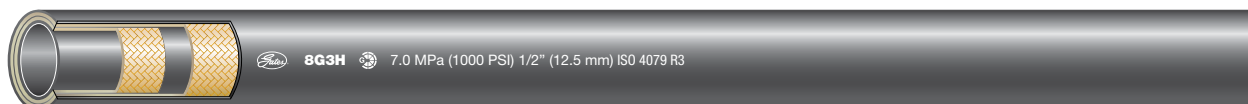

-size	DN		mm		PSI		MPa		mm	kg/100m	REF.
	DN	"	"	mm	PSI	MPa	PSI	MPa			
-4	6	1/4	0.56	14.2	1250	8.8	5000	35.0	75	19	4G3H
-6	10	3/8	0.75	19.1	1125	7.9	4500	31.5	100	33	6G3H
-8	12	1/2	0.94	23.9	1000	7.0	4000	28.0	125	48	8G3H
-10	16	5/8	1.10	27.9	900	6.2	3600	24.8	140	57	10G3H
-12	19	3/4	1.25	31.8	750	5.2	3000	21.0	150	71	12G3H
-16	25	1	1.50	38.1	565	3.9	2260	15.8	200	92	16G3H
-20	31	1.1/4	1.75	44.5	375	2.6	1500	10.5	250	110	20G3H

- RECOMMENDED FOR** High-temperature, low pressure hydraulic oil lines, anti-freeze solutions and water.
- TUBE** NBR (Nitrile) based.
- REINFORCEMENT** Two fibre braids.
- COVER** CR (Chloroprene) based.
- TEMPERATURE RANGE** -40°C to +135°C constant and +150°C intermittent.
For water emulsions, etc. see Engineering and technical data page 292.
- STANDARDS** Exceeds ISO 4079 R3. EN 854 R3. SAE 100R3.
- COUPLINGS** -4 to -10: MegaCrimp; for replacement of crimped assemblies with larger inner diameter we recommend to use ACR MegaTech™.

TABLE OF CONTENTS

ABOUT GATES

HYDRAULIC HOSE

HYDRAULIC HOSE COUPLINGS

ENGINEERING AND TECHNICAL DATA

MEGASYS™ WIRE AND TEXTILE BRAID HYDRAULIC HOSE



GTH

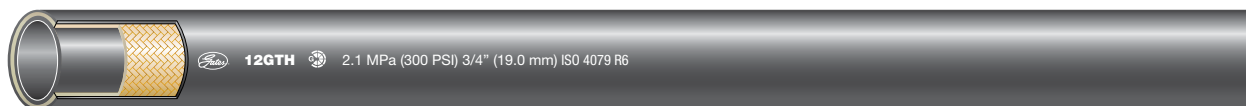

-size											REF.
	DN	"	"	mm	PSI	MPa	PSI	MPa	mm	kg/100m	
-4	6	1/4	0.50	12.7	400	2.8	1600	11.2	65	13	4GTH
-5	8	5/16	0.56	14.3	400	2.8	1600	11.2	75	15	5GTH
-6	10	3/8	0.63	15.9	400	2.8	1600	11.2	75	17	6GTH
-8	12	1/2	0.78	19.8	400	2.8	1600	11.2	100	23	8GTH
-10	16	5/8	0.91	23.0	350	2.4	1400	9.6	125	28	10GTH
-12	19	3/4	1.06	26.9	300	2.1	1200	8.4	150	38	12GTH
-16	25	1	1.32	33.5	250	1.7	1000	6.9	165	47	16GTH

- RECOMMENDED FOR** High-temperature, low pressure hydraulic oil lines, heavy-duty transmission oil cooler lines and glycol anti-freeze solutions.
- TUBE** NBR (Nitrile) based.
- REINFORCEMENT** One fibre braid.
- COVER** CR (Chloroprene) based.
- TEMPERATURE RANGE** -40°C to +135°C constant and +150°C intermittent.
For water emulsions, etc. see Engineering and technical data page 292.
- STANDARDS** Meets ISO 4079 R6 / EN 854 R6 / SAE 100R6 (-4 to -12).
- COUPLINGS** MegaCrimp™.

TABLE OF CONTENTS

ABOUT GATES

HYDRAULIC HOSE

HYDRAULIC HOSE
COUPLINGS

ENGINEERING AND
TECHNICAL DATA



MULTI MASTER™ GMV™



-size	↔		⊘		⌚		🌀		⌚		kg/100m	REF.
	DN	"	"	mm	PSI	MPa	PSI	MPa	mm			
-12	19	3/4	1.20	30.5	350	2.4	1400	9.6	20	60	MULTIMAS GMV 3/4"	
-16	25	1	1.41	35.8	300	2.1	1200	8.4	25	70	MULTIMAS GMV 1"	
-20	32	1.1/4	1.66	42.2	250	1.7	1000	6.8	30	90	MULTIMAS GMV 1.1/4"	
-24	38	1.1/2	1.90	48.3	150	1.0	600	4.1	40	130	MULTIMAS GMV 1.1/2"	
-32	51	2	2.39	60.7	150	1.0	600	4.1	50	140	MULTIMAS GMV 2"	
-40	64	2.1/2	2.94	74.7	150	1.0	600	4.1	65	180	MULTIMAS GMV 2.1/2"	
-48	76	3	3.44	87.4	150	1.0	600	4.1	75	220	MULTIMAS GMV 65 3"	
-64	102	4	4.48	113.8	150	1.0	600	4.1	100	340	MULTIMAS GMV 4"	
-96	152	6	6.55	166.4	150	1.0	600	4.1	150	600	MULTIMAS GMV 6"	

RECOMMENDED FOR

Applications requiring excellent flexibility and maximum resistance to air, water, coolant, petroleum lubricating oils and refined fuels.

Hydraulic return and suction lines transferring refined fuels or other petroleum products and SAE 20R5 coolant lines.

TUBE

NBR (Nitrile) based. Black. Meets ARPM Class A and SAE 20 Class B.

REINFORCEMENT

Synthetic, high tensile textile reinforcement with steel wire helix.

COVER

CR (Chloroprene) based. Black, corrugated. MSHA approved. Meets SAE 20 Class C.

TEMPERATURE RANGE

-40°C to +135°C. For fuel +49°C and coolant +100°C. For water emulsions, etc. see Engineering and technical data page 292.

STANDARDS

Meets SAE 100R4 / SAE 30R5 / SAE 20R5 (except for tube dimensions).

COUPLINGS

-12 to -20 : MegaCrimp™ ; -24 and -32 : GlobalSpiral Plus ; -40, -48 and -64 : GL Clamp over beaded nipple in low-pressure applications.

TYPE APPROVALS

DNV, GL and ABS.

CHARACTERISTICS/BENEFITS

- Highly flexible.
- 1:1 bend radius. Shorter routings using less hose.
- Easy to install.
- Kink resistant.
- Compatible with biodegradable hydraulic fluids like synthetic esters, polyglycols and vegetable oils as well as petroleum-based fluids.

IMPORTANT



Increased operating temperatures will reduce hose assembly service life. Do not transfer fuels over +49°C.



PRO™ SERIES

Gates PRO Series hydraulic hoses deliver performance and reliability in one- or two-wire braid construction. Engineered for less demanding hydraulic applications, our line of professional-grade hoses are designed to balance product performance and investment for everyday use. All sizes deliver consistent performance to EN industry specifications.



PROV



-size	↻		⊘		⊙		🌸		⤴	⚖	📏
	DN	"	"	mm	PSI	MPa	PSI	MPa	mm	kg/100m	REF.
-4	6	1/4	0.52	13.1	5800	40.0	23200	160.0	50	25	4PROV
-5	8	5/16	0.58	14.7	5000	35.0	20000	140.0	55	30	5PROV
-6	10	3/8	0.65	16.6	4800	33.0	19200	132.0	65	33	6PROV
-8	12	1/2	0.80	20.3	4000	27.5	16000	110.0	90	46	8PROV
-10	16	5/8	0.93	23.6	3625	25.0	14500	100.0	100	54	10PROV
-12	19	3/4	1.08	27.4	3100	21.5	12400	86.0	120	67	12PROV
-16	25	1	1.39	35.4	2400	16.5	9600	66.0	150	102	16PROV

- RECOMMENDED FOR TUBE** High pressure hydraulic application. Easy to route and install in tight areas.
- REINFORCEMENT** NBR (Nitrile) based.
- COVER** Braided high-tensile steel wire.
- TEMPERATURE RANGE** NBR/PVC based. MSHA approved.
- STANDARDS** -40°C to +100°C. For water emulsions, etc. see Engineering and technical data page 292.
- COUPLINGS** EN 857 2SC. SAE 100 R16. ISO 11237 2SC R16.
- IMPORTANT** EX.



PROV use the ferrules indicated in below table.

SIZE	EX Ferrule
-4	4EX1F-1
-5	5EX1F-1
-6	6EXVF-1
-8	8EXVF-1
-10	10EXVF-1
-12	12EX1F-1
-16	16EXVF-1

TABLE OF CONTENTS

ABOUT GATES

HYDRAULIC HOSE

HYDRAULIC HOSE COUPLINGS

ENGINEERING AND TECHNICAL DATA

PRO™ SERIES HYDRAULIC HOSE



PRO1T



-size											REF.
	DN	"	"	mm	PSI	MPa	PSI	MPa	mm	kg/100m	
-4	6	1/4	0.49	12.5	3250	22.5	13000	90.0	75	19	4PRO1T
-5	8	5/16	0.54	13.6	3100	21.5	12400	86.0	85	21	5PRO1T
-6	10	3/8	0.62	15.8	2600	18.0	10400	72.0	90	28	6PRO1T
-8	12	1/2	0.75	19.0	2325	16.0	9300	64.0	130	34	8PRO1T
-10	16	5/8	0.89	22.5	1900	13.0	7600	52.0	150	43	10PRO1T
-12	19	3/4	1.02	25.9	1525	10.5	6100	42.0	180	50	12PRO1T
-16	25	1	1.31	33.4	1275	8.8	5100	35.2	230	82	16PRO1T

RECOMMENDED FOR	High pressure hydraulic application. Easy to route and install in tight areas.
TUBE	NBR (Nitrile) based.
REINFORCEMENT	One braid of high-tensile steel wire.
COVER	SBR (Styrene-Butadiene) based. MSHA approved.
TEMPERATURE RANGE	-40°C to +100°C. For water emulsions, etc. see Engineering and technical data page 292.
STANDARDS	EN 857 1SC. ISO 11237 1SC.
COUPLINGS	EX.

TABLE OF CONTENTS

ABOUT GATES

HYDRAULIC HOSE

HYDRAULIC HOSE
COUPLINGS

ENGINEERING AND
TECHNICAL DATA



CR2



-size	↻		⊘		⊘		🌸		⚖️		REF.
	DN	"	"	mm	PSI	MPa	PSI	MPa	mm	kg/100m	
-4	6	1/4	0.57	14.5	5800	40.0	23200	160.0	100	33	4CR2
-5	8	5/16	0.64	16.3	5000	34.0	20000	140.0	115	39	5CR2
-6	10	3/8	0.73	18.5	4800	33.0	19200	132.0	130	57	6CR2
-8	12	1/2	0.85	21.6	4000	27.5	16000	110.0	180	60	8CR2
-10	16	5/8	0.98	24.9	3625	25.0	14500	100.0	200	70	10CR2
-12	19	3/4	1.14	29.0	3125	21.5	12500	86.0	240	86	12CR2
-16	25	1	1.46	37.1	2400	16.5	9600	66.0	300	126	16CR2

- RECOMMENDED FOR** High pressure hydraulic application.
- TUBE** NBR (Nitrile) based.
- REINFORCEMENT** Two braids of high-tensile steel wire.
- COVER** SBR (Styrene-Butadiene) based. MSHA approved.
- TEMPERATURE RANGE** -40°C to +100°C. For water emulsions, etc. see Engineering and technical data page 292.
- STANDARDS** EN 853 2SN.
- COUPLINGS** EX.

PRO™ SERIES HYDRAULIC HOSE

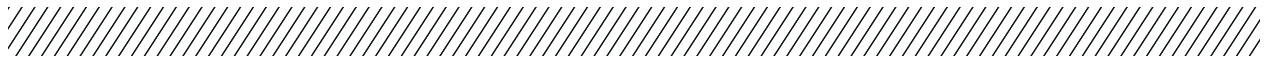

CR1

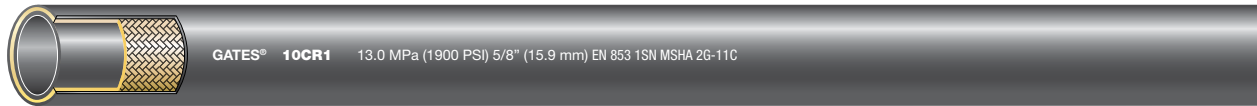

-size									mm	kg/100m	REF.
	DN	"	"	mm	PSI	MPa	PSI	MPa			
-4	6	1/4	0.52	13.2	3250	22.5	13000	90.0	100	21	4CR1
-5	8	5/16	0.59	15.1	3100	21.5	12400	86.0	115	26	5CR1
-6	10	3/8	0.66	16.8	2600	18.0	10400	72.0	130	34	6CR1
-8	12	1/2	0.78	19.8	2325	16.0	9300	64.0	180	39	8CR1
-10	16	5/8	0.91	23.1	1900	13.0	7600	52.0	200	43	10CR1
-12	19	3/4	1.07	27.2	1525	10.5	6100	42.0	240	55	12CR1
-16	25	1	1.38	35.1	1275	8.8	5100	35.2	300	82	16CR1

RECOMMENDED FOR	High pressure hydraulic application.
TUBE	NBR (Nitrile) based.
REINFORCEMENT	One braid of high-tensile steel wire.
COVER	SBR (Styrene-Butadiene) based. MSHA approved.
TEMPERATURE RANGE	-40°C to +100°C. For water emulsions, etc. see Engineering and technical data page 292.
STANDARDS	EN 853 1SN.
COUPLINGS	EX.

TABLE OF CONTENTS

ABOUT GATES

HYDRAULIC HOSE

HYDRAULIC HOSE
COUPLINGS

ENGINEERING AND
TECHNICAL DATA



IA3K



-size	DN		mm		PSI		MPa		mm	kg/100m	REF.
	DN	"	"	mm	PSI	MPa	PSI	MPa			
-4	6	1/4	0.48	12.2	3000	21.0	12000	84.0	50	18	4IA3K
-5	8	5/16	0.54	13.6	3000	21.0	12000	84.0	55	21	5IA3K
-6	10	3/8	0.63	15.9	3000	21.0	12000	84.0	65	28	6IA3K
-8	12	1/2	0.78	19.8	3000	21.0	12000	84.0	90	42	8IA3K
-10	16	5/8	0.93	23.6	3000	21.0	12000	84.0	100	52	10IA3K

- RECOMMENDED FOR** High pressure hydraulic application. Easy to route and install in tight areas.
- TUBE** NBR (Nitrile) based.
- REINFORCEMENT** One braid of high-tensile steel wire.
- COVER** NBR/PVC based. MSHA approved.
- TEMPERATURE RANGE** -40°C to +100°C. For water emulsions, etc. see Engineering and technical data page 292.
- STANDARDS** SAE 100 R17. ISO 18752 Type A.
- COUPLINGS** EX.

TABLE OF CONTENTS

ABOUT GATES

HYDRAULIC HOSE

HYDRAULIC HOSE COUPLINGS

ENGINEERING AND TECHNICAL DATA



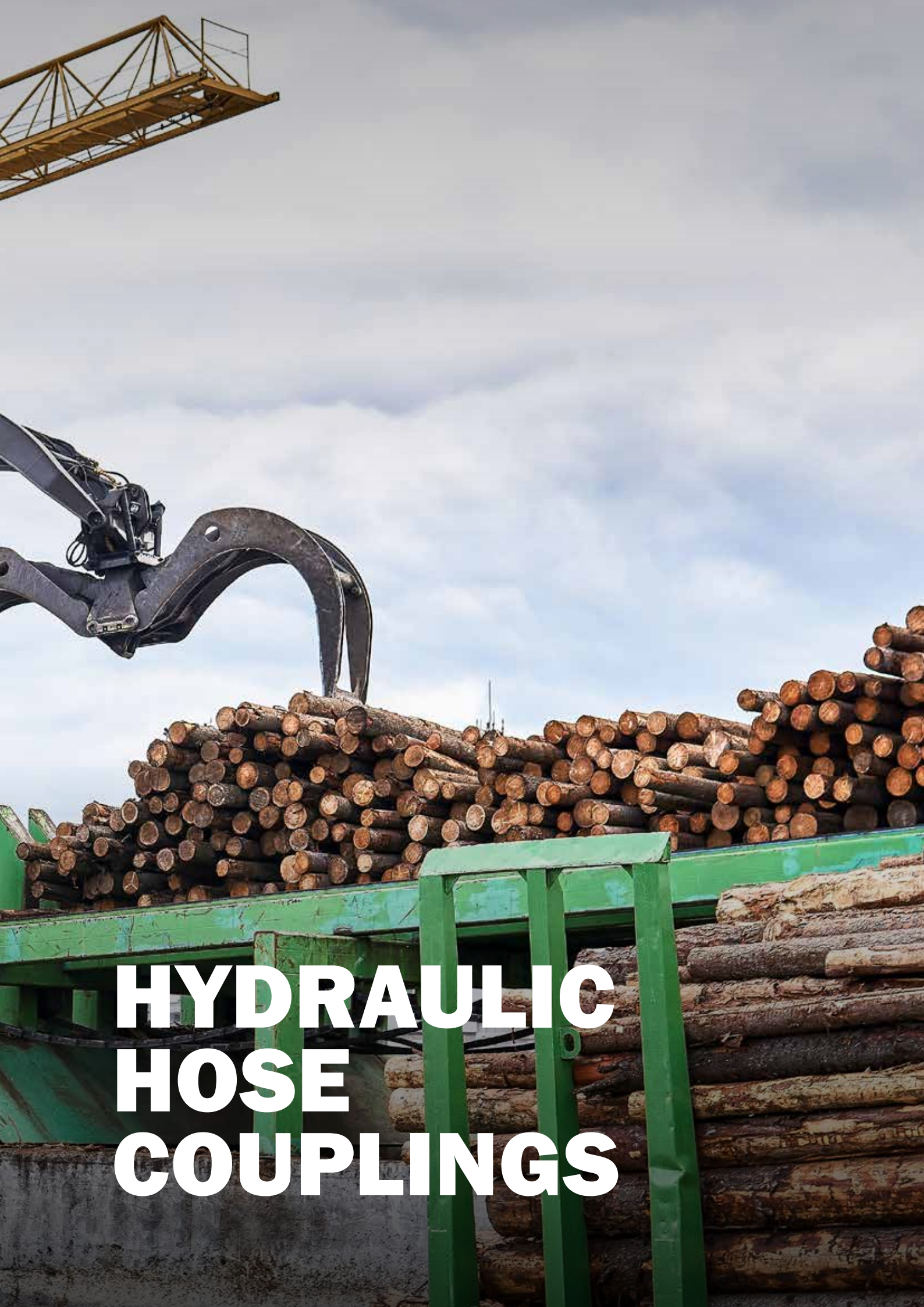

HYDRAULIC HOSE COUPLINGS

COUPLING SELECTION TABLE



MEGASYS COUPLINGS FOR SPIRAL WIRE AND XPIRAL HYDRAULIC HOSE

GlobalSpiral Maximum

EFG6K (-24:-32), EFG5K (-24:-32) , EFG5KL (-24)

BSP				JIC
BSP FBSPORX p. 102	BSP FBSPORX45 p. 102	BSP FBSPORX90 p. 102	BSP MBSPP p. 103	JIC FJX p. 103

JIC			SAE	
JIC FJX45 p. 103	JIC FJX90 p. 104	JIC MJ p. 104	SAE FFORX p. 104	SAE FFORX45 p. 105

SAE				
SAE FFORX90 p. 105	SAE FL p. 105	SAE FL45 p. 106	SAE FL90 p. 106	SAE FLHCFM p. 106

SAE				
SAE FLHCFM45 p. 107	SAE FLHCFM90 p. 107	SAE FLH p. 107	SAE FLH22 p. 108	SAE FLH30 p. 108

TABLE OF CONTENTS

ABOUT GATES

HYDRAULIC HOSE



HYDRAULIC HOSE COUPLINGS

ENGINEERING AND TECHNICAL DATA

COUPLING SELECTION TABLE

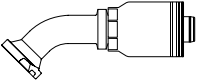
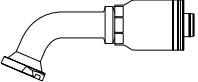
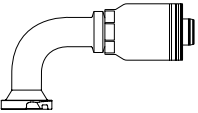
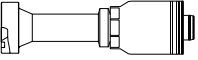
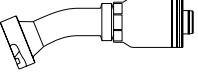

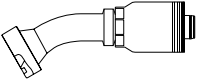
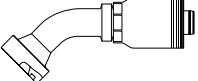
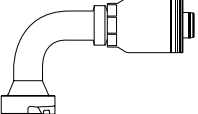
SAE			CATERPILLAR	
				
SAE FLH45 p. 108	SAE FLH60 p. 109	SAE FLH90 p. 109	FLC p. 109	FLC22 p. 110

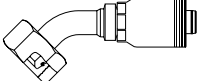
CATERPILLAR			DIN	
				
FLC30 p. 110	FLC45 p. 110	FLC90 p. 111	DIN 24° FDHORX p. 111	DIN 24° FDHORX45 p. 111

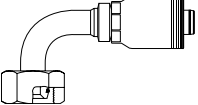
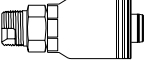
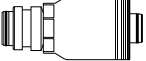
DIN	NPTF	PRESS-LOK SUPER
		
DIN 24° FDHORX90 p. 112	NPTF MP p. 112	PLSOR p. 112

GlobalSpiral

EFG6K (-06:-20), EFG5K (-06:-20), MXG5K, EFG4K, MXG4K, EFG3K (-20:-32), EFG6KL, EFG5KL (-06:-20), EFG4KL

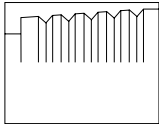
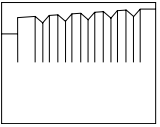
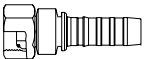
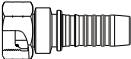
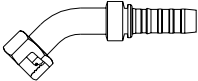
FERRULES		BSP		
				
NO-SKIVE FERRULES FOR SPIRAL WIRE HOSE p. 113	NO-SKIVE FERRULES FOR SPIRAL HOSE p. 113	BSP FBSPORX p. 114	BSP FBSPORX-RB p. 115	BSP FBSPORX45 p. 115

COUPLING SELECTION TABLE



TABLE OF CONTENTS

ABOUT GATES

HYDRAULIC HOSE

HYDRAULIC HOSE COUPLINGS

ENGINEERING AND TECHNICAL DATA

BSP				JIC
BSP FBSPORX90 p. 116	BSP FBSPORX180 p. 116	BSP MBSPP p. 117	BSP MBSPP-RB p. 117	JIC 37° FJX p. 118

JIC				
JIC 37° FJX45 p. 119	JIC 37° FJX90S p. 119	JIC 37° FJX90M p. 120	JIC 37° FJX90L p. 120	JIC 37° MJ p. 121

JIS	SAE			
JIS FKX p. 121	SAE FFORX p. 122	SAE FFORX45 p. 123	SAE FFORX90S p. 124	SAE FFORX90M p. 125

SAE				
SAE FFORX90L p. 125	SAE MFFOR p. 126	SAE FL p. 126	SAE FL22 p. 127	SAE FL30 p. 127

SAE				
SAE FL45 p. 128	SAE FL60 p. 128	SAE FL67 p. 129	SAE FL90S p. 129	SAE FL90M p. 130

COUPLING SELECTION TABLE



SAE

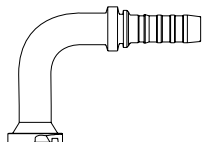

SAE FL90L
p. 131

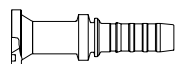

SAE FLH
p. 131

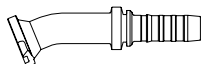

SAE FLH22
p. 132

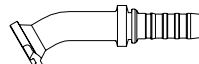

SAE FLH30
p. 132

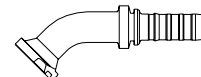

SAE FLH45
p. 133

SAE

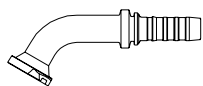

SAE FLH60
p. 133

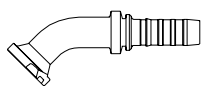

SAE FLH67
p. 134

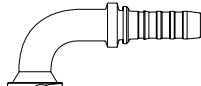

SAE FLH90S
p. 134

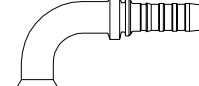

SAE FLH90M
p. 135

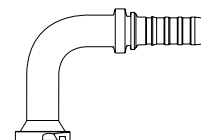

SAE FLH90L
p. 135

SAE	KOMATSU			CATERPILLAR
-----	---------	--	--	-------------

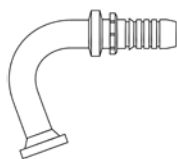

SAE FLH130
p. 136

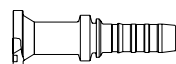

FLK
p. 136

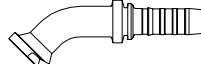

FLK45
p. 137

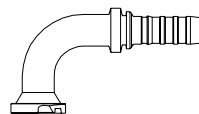

FLK90
p. 137

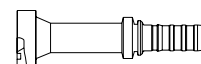

FLC
p. 138

CATERPILLAR

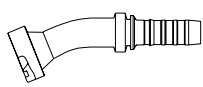

FLC22
p. 138

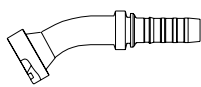

FLC30
p. 139

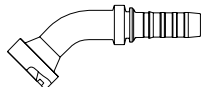

FLC45
p. 139

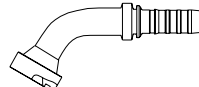

FLC60
p. 140

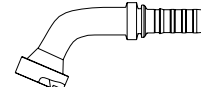

FLC67
p. 140

CATERPILLAR	DIN			
-------------	-----	--	--	--

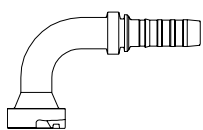

FLC90
p. 141

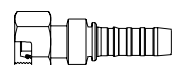

DIN 24° FDLORX
p. 141

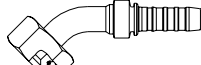

DIN 24° FDLORX45
p. 142

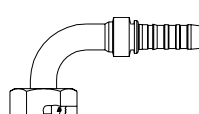

DIN 24° FDLORX90
p. 142



DIN 24° MDL
p. 143

COUPLING SELECTION TABLE



TABLE OF CONTENTS

ABOUT GATES

HYDRAULIC HOSE

HYDRAULIC HOSE COUPLINGS

ENGINEERING AND TECHNICAL DATA

DIN				
DIN 24° FDHORX p. 144	DIN 24° FDHORX-RB p. 144	DIN 24° FDHORX45 p. 145	DIN 24° FDHORX90 p. 145	DIN 24° MDH p. 146
NPTF	UNF	FRENCH GAZ		
NPTF MP p. 146	UNF MB p. 147	FG FFGX p. 147	FG FFGX90 p. 148	FG MFG p. 148
FRENCH GAZ		KOBELCO	HOSE LENGTH EXTENDER	
FG FPFL p. 149	FG MPFL p. 149	FG MPFL90 p. 150	KOBELCO MKB p. 150	HLE p. 151
HOSE LENGTH EXTENDER	PRESS-LOK	PRESS-LOK SUPER		
HLE90 p. 151	PL p. 152	PLSOR p. 152		

COUPLING SELECTION TABLE



MEGASYS COUPLINGS FOR WIRE AND TEXTILE BRAIDED HYDRAULIC HOSE

Global Low

MultiMaster GMV (-40;-64)

JIC	SAE			
JIC 37° FJX p. 154	SAE FL p. 154	SAE FL22 p. 155	SAE FL30 p. 155	SAE FL45 p. 156

SAE		
SAE FL60 p. 156	SAE FL67 p. 157	SAE FL90 p. 157

GlobalSpiral Plus

M2T (-24:-32), G2 (-24:-32), G1 (-24:-32), MultiMaster GMV (-24:-32), G2XH (-24:-32), G2H (-24:-32), G2L (-24:-32), G1H (-24:-32)

FERRULES	BSP			
NO-SKIVE FERRULES p. 158	BSP FBSPORX p. 158	BSP FBSPORX45 p. 158	BSP FBSPORX90 p. 159	BSP MBSPP p. 159

JIC				SAE
JIC 37° FJX p. 159	JIC 37° FJX45 p. 160	JIC 37° FJX90 p. 160	JIC 37° MJ p. 160	SAE FFORX p. 161

COUPLING SELECTION TABLE



TABLE OF CONTENTS

ABOUT GATES

HYDRAULIC HOSE

HYDRAULIC HOSE COUPLINGS

ENGINEERING AND TECHNICAL DATA

SAE

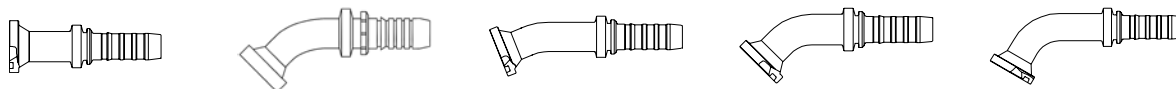

SAE FL p. 161	SAE FL22 p. 161	SAE FL30 p. 162	SAE FL45 p. 162	SAE FL60 p. 162
-------------------------	---------------------------	---------------------------	---------------------------	---------------------------

SAE DIN

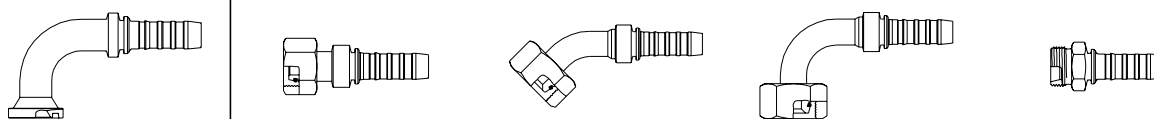

SAE FL90 p. 163	DIN 24° FDLORX p. 163	DIN 24° FDLORX45 p. 163	DIN 24° FDLORX90 p. 164	DIN 24° MDL p. 164
---------------------------	---------------------------------	-----------------------------------	-----------------------------------	------------------------------

DIN NPTF

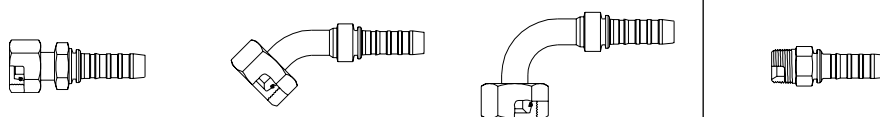

DIN 24° FDHORX p. 164	DIN 24° FDHORX45 p. 165	DIN 24° FDHORX90 p. 165	NPTF MP p. 165
---------------------------------	-----------------------------------	-----------------------------------	--------------------------

MegaCrimp™

M6K, MXG5K (-06:-08), M5K, MXG4K (-06:-12), M4K, M3K, M2T (-04:-20), MXT, CM2TDL-XTF, G1 (-04:-20), TH8, TH7, TH7DL, G3H (-04:-10), GTH, MultiMaster GMV (-04:-20), M4KH, M4KL, M3KH, G2XH (-04:-20), G2H (-20), G2L (-04:-20), G1H (-04:-20)

BSP

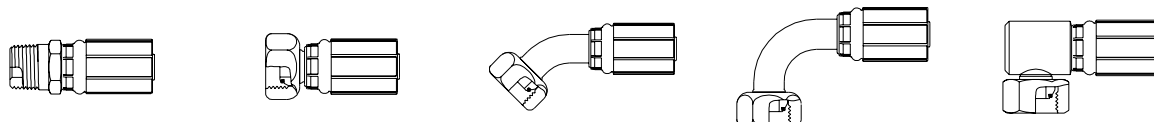

BSP MBSPT p. 166	BSP FBSPORX p. 167	BSP FBSPORX45 p. 168	BSP FBSPORX90 p. 169	BSP FBSPORX90BL p. 170
----------------------------	------------------------------	--------------------------------	--------------------------------	----------------------------------

COUPLING SELECTION TABLE

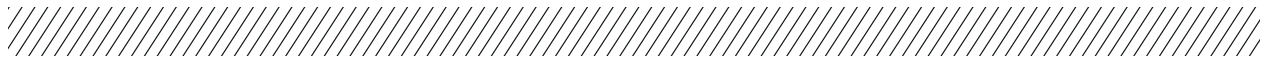

BSP				
BSP FBSPORX180 p. 170	BSP MBSPP p. 171	BSP MBSPPBKHD p. 172	BSP FBFFX p. 172	BSP MBFF p. 173

BSP	JIC			
BSP BANJO p. 173	JIC 37° FJX p. 174	JIC 37° FJX45 p. 175	JIC 37° FJX90S p. 176	JIC 37° FJX90M p. 177

JIC	JIS		SAE
JIC 37° FJX90L p. 178	JIC 37° MJ p. 179	JIS FJISX p. 180	SAE FFORX p. 181

SAE				
SAE FFORX45S p. 182	SAE FFORX90S p. 183	SAE FFORX90M p. 184	SAE FFORX90L p. 185	SAE MFFOR p. 186

SAE				
SAE MFFORBKHD p. 186	SAE 45° FSX p. 187	SAE 45° FSX45 p. 188	SAE 45° FSX90 p. 188	SAE 45° MS p. 189

TABLE OF CONTENTS
ABOUT GATES
HYDRAULIC HOSE
HYDRAULIC HOSE COUPLINGS
ENGINEERING AND TECHNICAL DATA

COUPLING SELECTION TABLE

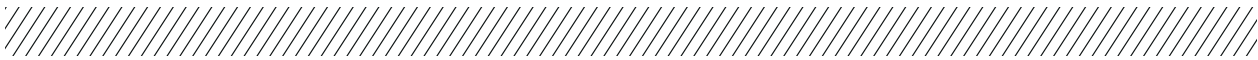

TABLE OF CONTENTS

ABOUT GATES

HYDRAULIC HOSE

HYDRAULIC HOSE COUPLINGS

ENGINEERING AND TECHNICAL DATA

SAE

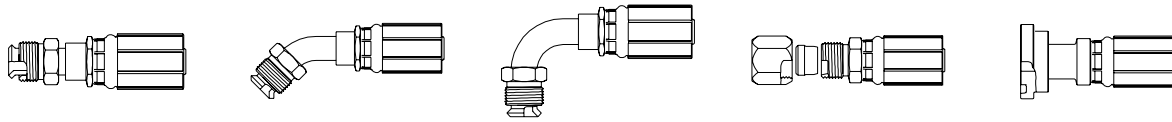

SAE 45° MIX
p. 189

SAE 45° MIX45
p. 190

SAE 45° MIX90
p. 190

SAE 24° MFA
p. 191

SAE FL
p. 191

SAE

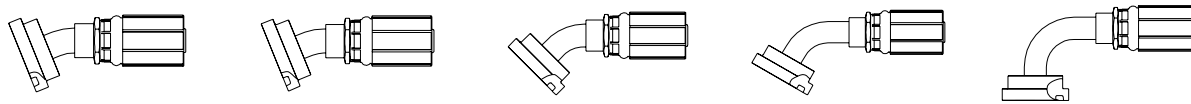

SAE FL22
p. 192

SAE FL30
p. 192

SAE FL45
p. 193

SAE FL60
p. 193

SAE FL90
p. 194

SAE	KOMATSU			DIN
				
SAE FLH90 p. 194	FLK p. 195	FLK45 p. 195	FLK90 p. 196	DIN 24° FDLORX p. 197

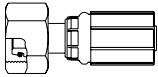
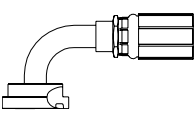
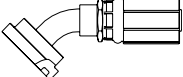
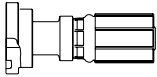
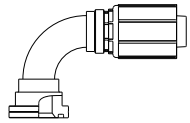

SAE FLH90
p. 194

FLK
p. 195

FLK45
p. 195

FLK90
p. 196

DIN 24° FDLORX
p. 197

DIN

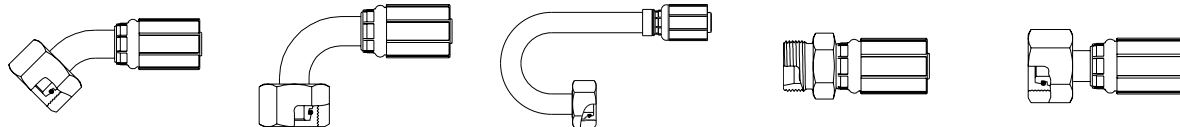

DIN 24° FDLORX45
p. 198

DIN 24° FDLORX90
p. 199

DIN 24° FDLORX180
p. 200

DIN 24° MDL
p. 200

DIN 24° FDHORX
p. 201

DIN

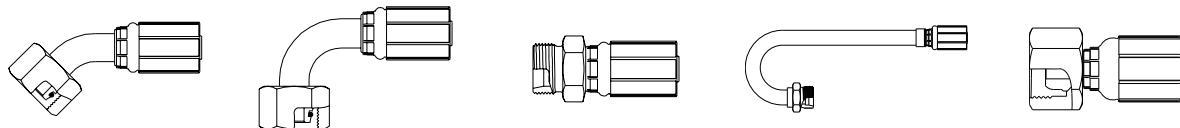

DIN 24° FDHORX45
p. 202

DIN 24° FDHORX90
p. 203

DIN 24° MDH
p. 204

DIN 24° MDH180
p. 204

DIN 24° / 60° FDLX
p. 205

COUPLING SELECTION TABLE



DIN			NPTF	
DIN 24° / 60° FDHX p. 205	METRIC MSP p. 206	METRIC DBJ p. 207	NPTF FPX p. 208	NPTF MP p. 209

NPTF			UNF	
NPTF MPLN p. 210	NPTF FP p. 210	NPTF MPX p. 211	NPTF MPX90 p. 211	UNF MB p. 212

UNF			FRENCH GAZ	
UNF MBX p. 213	UNF MBX45BL p. 213	UNF MBX90 p. 214	UNF MBX90BL p. 214	FG FFGX p. 215

FRENCH GAZ			HLE	PRESS-LOK
FG FFGX45 p. 215	FG FFGX90 p. 216	FG MFG p. 216	HLE p. 217	PL p. 217

AGRICULTURAL VALVE	POWERWASH		QUICK-LOK HIGH	
AV p. 218	PRESSUREWASH FPWXL p. 218	PRESSUREWASH PWSP p. 219	QUICK-LOK HIGH MQLH p. 219	QUICK-LOK HIGH MQLH45 p. 220

TABLE OF CONTENTS

ABOUT GATES

HYDRAULIC HOSE

HYDRAULIC HOSE COUPLINGS

ENGINEERING AND TECHNICAL DATA

COUPLING SELECTION TABLE

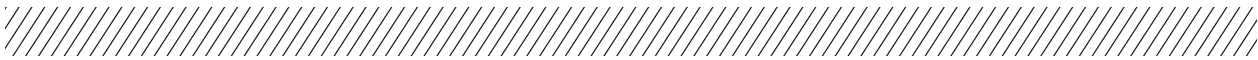

QUICK-LOK HIGH

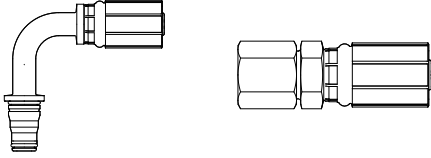

QUICK-LOK HIGH MQLH90
p. 220

QUICK-LOK HIGH FQLH
p. 221

MEGASYS COUPLINGS FOR PILOT HYDRAULIC HOSE

P1T

FERRULES	BSP			JIC
NO-SKIVE FERRULES p. 223	BSP FBSPORX p. 223	BSP FBSPORX45 p. 223	BSP FBSPORX90 p. 224	JIC 37° FJX p. 224

JIC	SAE			DIN
JIC 37° MJ p. 224	SAE FFORX p. 225	SAE FFORX45 p. 225	SAE FFORX90 p. 225	DIN 24° FDLORX p. 226

DIN			METRIC	Quick-Lok Direct
DIN 24° FDLORX45 p. 226	DIN 24° FDLORX90 p. 226	DIN 24° MDL p. 227	METRIC DBJ p. 227	MQLD p. 227

TABLE OF CONTENTS

ABOUT GATES

HYDRAULIC HOSE



HYDRAULIC HOSE COUPLINGS

ENGINEERING AND TECHNICAL DATA

COUPLING SELECTION TABLE

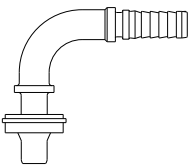

Quick-Lok Direct			Quick-Lok Low	
				
MQLD45 p. 228	MQLD90 p. 228	QLD RELEASE TOOL p. 228	MQLL p. 229	MQLL45 p. 229

Quick-Lok Low	
	
MQLL90 p. 229	QLL RELEASE TOOL p. 230

PRO SERIES COUPLINGS FOR PRO SERIES HYDRAULIC HOSE

EX

PROV, PRO1T, CR2, CR1, IA3K

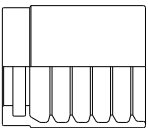
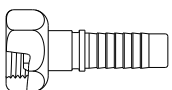
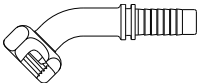
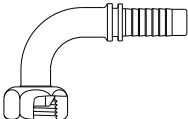
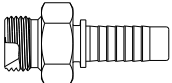
FERRULES	BSP			
				
NO-SKIVE FERRULES p. 232	BSP FBSPPX p. 233	BSP FBSPPX45 p. 233	BSP FBSPPX90 p. 234	BSP MBSPP p. 234

BSP	JIC			
				
BSP BSPBJ p. 235	JIC 37° FJX p. 235	JIC 37° FJX45S p. 236	JIC 37° FJX90S p. 236	JIC 37° MJ p. 237

TABLE OF CONTENTS
ABOUT GATES
HYDRAULIC HOSE
HYDRAULIC HOSE COUPLINGS
ENGINEERING AND TECHNICAL DATA

COUPLING SELECTION TABLE

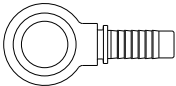
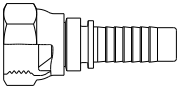
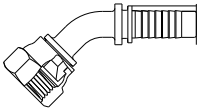
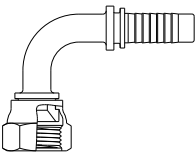
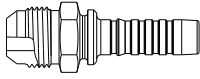

TABLE OF CONTENTS

ABOUT GATES

HYDRAULIC HOSE

HYDRAULIC HOSE COUPLINGS

ENGINEERING AND TECHNICAL DATA

SAE				DIN
SAE FFORX p. 238	SAE FFORX45S p. 238	SAE FFORX90S p. 239	SAE MFFOR p. 239	DIN 24° FDLORX p. 240

DIN				
DIN 24° FDLORX45 p. 241	DIN 24° FDLORX90 p. 242	DIN 24° MDL p. 243	DIN 24° FDHORX p. 244	DIN 24° FDHORX45 p. 245

DIN		METRIC		NPTF
DIN 24° FDHORX90 p. 246	DIN 24° MDH p. 247	METRIC MSP p. 247	METRIC DBJ p. 248	NPTF MP p. 248

ACCESSORIES

FLANGES

SAE

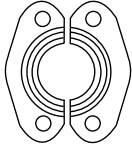

SAE PA-FL FLANGE KIT
p. 250

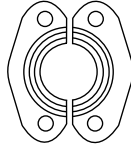

SAE PH-FLH FLANGE KIT
p. 250

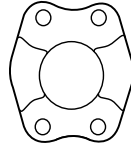

SAE PH-FLH MONOBLOC KIT
p. 251

BANJO BOLTS & SEALS

BSP



BSP BONDED SEAL
p. 252

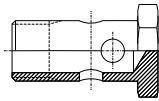

BSP BANJO BOLT (SINGLE)
p. 253

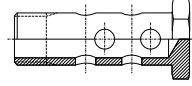

BSP BANJO BOLT (DOUBLE)
p. 253

DIN



DIN BONDED SEAL
p. 252

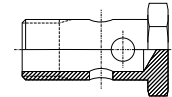

METRIC BANJO BOLT (SINGLE)
p. 254

DIN

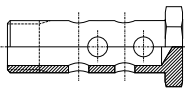

METRIC BANJO BOLT (DOUBLE)
p. 254



MEGASYS™

Gates MEGASys hydraulic hose and coupling products offer an integrated solution to combination of technology and performance. The fully integrated MEGASys hose line is designed to provide maximum flexibility and high-quality in a wide range of high-pressure hydraulic applications while simplifying hose selection and assembly fabrication.



**MEGASYS™ COUPLINGS
FOR SPIRAL WIRE AND
XPIRAL™ HYDRAULIC HOSE**



BSP FBSPORX

Female BSP 'O' ring swivel.
60° cone.

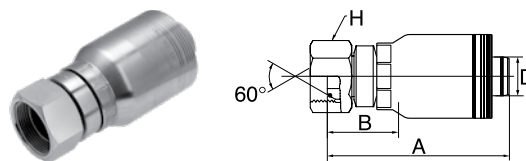

D				A B H			REF.
-size	DN	"		mm	mm	mm	GSM
-24	40	1.1/2	G 1.1/2" - 11 BSP	154.0	59.0	55.0	24GSM24FBSPORX
-32	50	2	G 2" - 11 BSP	184.0	70.0	70.0	32GSM32FBSPORX

-24 size is 35.0 MPa (5000 psi); -32 size is 28.0 MPa (4000 psi).

BSP FBSPORX45

Female BSP 'O' ring swivel. 60° cone.
45° swept elbow.

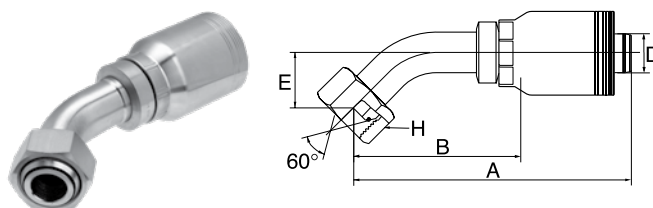

D				A B E H				REF.
-size	DN	"		mm	mm	mm	mm	GSM
-24	40	1.1/2	G 1.1/2" - 11 BSP	242.5	147.5	49.7	55.0	24GSM24FBSPORX45
-32	50	2	G 2" - 11 BSP	307.6	193.6	75.0	70.0	32GSM32FBSPORX45

-24 size is 35.0 MPa (5000 psi); -32 size is 28.0 MPa (4000 psi).

BSP FBSPORX90

Female BSP 'O' ring swivel. 60° cone.
90° swept elbow.

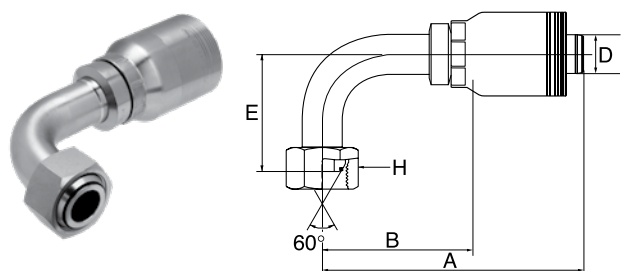

D				A B E H				REF.
-size	DN	"		mm	mm	mm	mm	GSM
-24	40	1.1/2	G 1.1/2" - 11 BSP	222.6	127.6	100.0	55.0	24GSM24FBSPORX90
-32	50	2	G 2" - 11 BSP	276.5	162.5	150.0	70.0	32GSM32FBSPORX90

-24 size is 35.0 MPa (5000 psi); -32 size is 28.0 MPa (4000 psi).

Unless otherwise stated the coupling meets the pressure rating requirements of the respective international standard.

TABLE OF CONTENTS

ABOUT GATES

HYDRAULIC HOSE

HYDRAULIC HOSE COUPLINGS

ENGINEERING AND TECHNICAL DATA

BSP MBSPP

Male BSP parallel. 60° inverted cone.

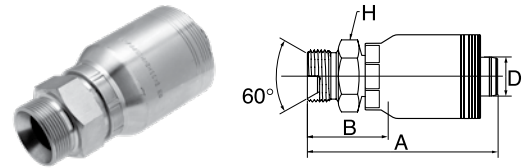

D			G	A B H			REF. GSM
-size	DN	"		mm	mm	mm	
-24	40	1.1/2	G 1.1/2" - 11 BSP	163.0	68.0	55.0	24GSM24MBSPP
-32	50	2	G 2" - 11 BSP	188.0	74.0	70.0	32GSM32MBSPP

-24 size is 35.0 MPa (5000 psi); -32 size is 28.0 MPa (4000 psi).

JIC FJX

Female JIC swivel. 37° inverted cone.

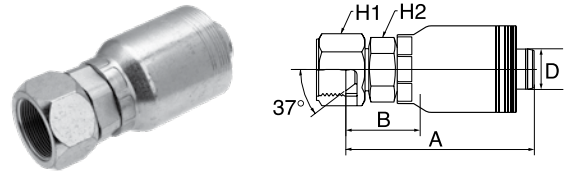

D			G	A B H1 H2				REF. GSM
-size	DN	"		mm	mm	mm	mm	
-24	40	1.1/2	1.7/8" - 12 UN	152.9	57.9	60.0	55.0	24GSM24FJX
-32	50	2	2.1/2" - 12 UN	180.5	66.5	75.0	70.0	32GSM32FJX

-24 to -32 size are 35.0 MPa (5000 psi).

JIC FJX45

Female JIC swivel. 37° inverted cone.
45° swept elbow.

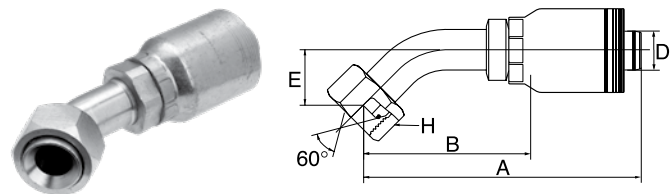

D			G	A B E H1 H2					REF. GSM
-size	DN	"		mm	mm	mm	mm	mm	
-24	40	1.1/2	1.7/8" - 12 UN	226.1	130.9	34.0	60.0	55.0	24GSM24FJX45-034

-24 size is 35.0 MPa (5000 psi).

Unless otherwise stated the coupling meets the pressure rating requirements of the respective international standard.

JIC FJX90

Female JIC swivel. 37° inverted cone.
90° swept elbow.

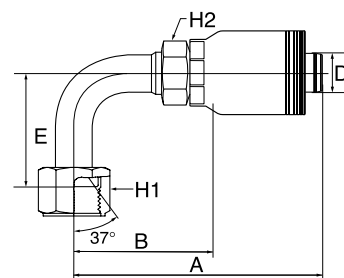

D			1.7/8" - 12 UN	A B E H1 H2					REF. GSM
-size	DN	"		mm	mm	mm	mm	mm	
-24	40	1.1/2	1.7/8" - 12 UN	227.5	132.3	86.0	60.0	55.0	24GSM24FJX90M

-24 size is 35.0 MPa (5000 psi). / M: Medium drop per ISO 12151-5.

JIC MJ

Male JIC parallel. 37° cone.

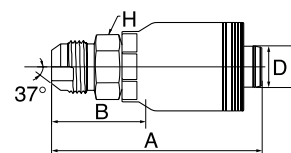

D			1.7/8" - 12 UN	A B H			REF. GSM
-size	DN	"		mm	mm	mm	
-24	40	1.1/2	1.7/8" - 12 UN	162.3	67.3	50.0	24GSM24MJ
-32	50	2	2.1/2" - 12 UN	196.2	82.2	65.0	32GSM32MJ

-24 to -32 size are 35.0 MPa (5000 psi).

SAE FFORX

Female SAE flat face 'O' ring swivel.

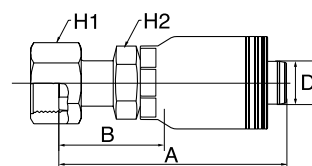

D			2" - 12 UN	A B H1 H2				REF. GSM
-size	DN	"		mm	mm	mm	mm	
-24	40	1.1/2	2" - 12 UN	164.4	69.4	60.0	55.0	24GSM24FFORX

-24 size is 28.0 MPa (4000 psi).

Unless otherwise stated the coupling meets the pressure rating requirements of the respective international standard.

TABLE OF CONTENTS

ABOUT GATES

HYDRAULIC HOSE

HYDRAULIC HOSE COUPLINGS

ENGINEERING AND TECHNICAL DATA

SAE FFORX45

Female SAE flat face 'O' ring swivel.
45° swept elbow.

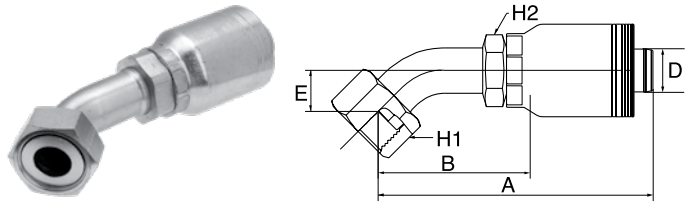

D			2" - 12 UN	A B E H1 H2					REF.
-size	DN	"		mm	mm	mm	mm	mm	GSM
-24	40	1.1/2	2" - 12 UN	236.6	141.4	38.0	60.0	55.0	24GSM24FFORX45-038

-24 size is 28.0 MPa (4000 psi).

SAE FFORX90

Female SAE flat face 'O' ring swivel.
90° swept elbow.

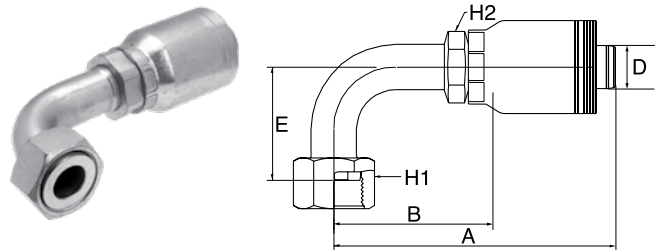

D			2" - 12 UN	A B E H1 H2					REF.
-size	DN	"		mm	mm	mm	mm	mm	GSM
-24	40	1.1/2	2" - 12 UN	227.4	132.3	86.0	60.0	55.0	24GSM24FFORX90M

-24 size is 28.0 MPa (4000 psi). / M: Medium drop per ISO 12151-1.

SAE FL

SAE 'O' ring flange. Code 61.

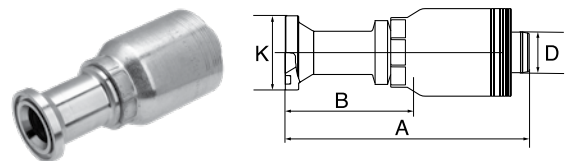

D			1.1/2" 2"	A B K			KIT	REF.
-size	DN	"		mm	mm	mm		GSM
-24	40	1.1/2	1.1/2"	180.0	85.0	60.3	24 PA-FL	24GSM24FL
-32	50	2	2"	251.4	137.4	71.4	32 PA-FL	32GSM32FL

Details on flange kits see page 250.

Unless otherwise stated the coupling meets the pressure rating requirements of the respective international standard.

TABLE OF CONTENTS
ABOUT GATES
HYDRAULIC HOSE
HYDRAULIC HOSE COUPLINGS
ENGINEERING AND TECHNICAL DATA

SAE FL45

SAE O' ring flange. Code 61.
45° swept elbow.

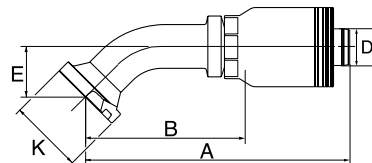

D			A	B	E	K	KIT	REF.
-size	DN	"						
-24	40	1.1/2	1.1/2"	230.0	135.0	44.0	60.3	24 PA-FL 24GSM24FL45M
-32	50	2	2"	288.0	173.6	56.0	71.4	32 PA-FL 32GSM32FL45M

Details on flange kits see page 250. / M: Medium drop per ISO 12151-3.

SAE FL90

SAE 'O' ring flange. Code 61.
90° swept elbow.

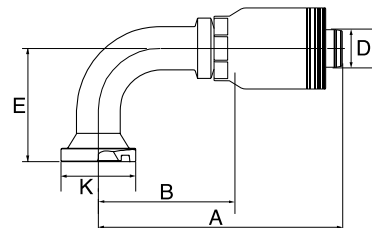

D			A	B	E	K	KIT	REF.
-size	DN	"						
-24	40	1.1/2	1.1/2"	214.9	119.9	81.0	60.3	32 PA-FL 24GSM24FL90S
-32	50	2	2"	265.0	150.5	130.0	71.4	32 PA-FL 32GSM32FL90-130

Details on flange kits see page 250. / S: Short drop per ISO 12151-3.

SAE FLHCFM

SAE 'O' ring flange with pre-installed monobloc.
Code 62.

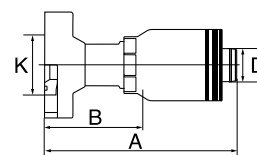

D			A	B	K	REF.	
-size	DN	"					mm
-24	40	1.1/2	1.1/2"	200.0	105.0	63.5	24GSM24FLHCFM
-32	50	2	2"	251.4	137.4	79.5	32GSM32FLHCFM

Unless otherwise stated the coupling meets the pressure rating requirements of the respective international standard.

SAE FLHCFM45

SAE 'O' ring flange with pre-installed monobloc.
Code 62. 45° swept elbow.

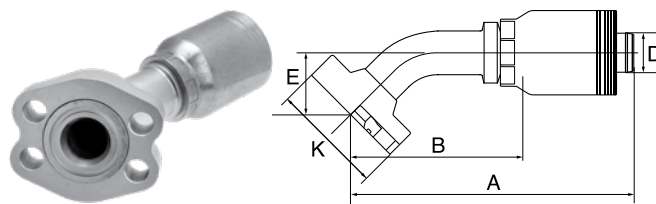

D				A B E K				REF.
-size	DN	"		mm	mm	mm	mm	GSM
-24	40	1.1/2	1.1/2"	232.0	137.0	44.0	63.5	24GSM24FLHCFM45M
-32	50	2	2"	297.0	182.5	63.0	79.5	32GSM32FLHCFM45-063

M: Medium drop per ISO 12151-3.

SAE FLHCFM90

SAE 'O' ring flange with pre-installed monobloc.
Code 62. 90° swept elbow.

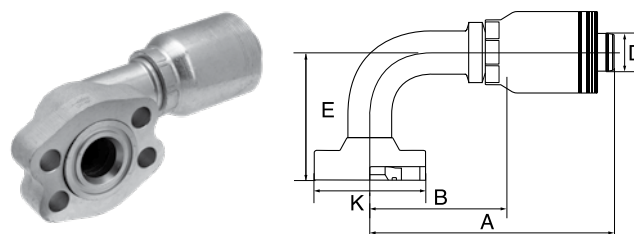

D				A B E K				REF.
-size	DN	"		mm	mm	mm	mm	GSM
-24	40	1.1/2	1.1/2"	214.0	119.0	94.0	63.5	24GSM24FLHCFM90-094
-32	50	2	2"	264.0	150.0	120.0	79.5	32GSM32FLHCFM90S

S: Short drop per ISO 12151-3.

SAE FLH

SAE 'O' ring flange high-pressure.
Code 62.

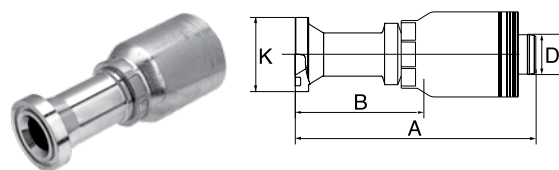

D				A B K			KIT	REF.
-size	DN	"		mm	mm	mm		GSM
-24	40	1.1/2	1.1/2"	200.0	105.0	63.5	24 PH-FLH	24GSM24FLH
-24	40	1.1/2	2"	200.0	105.0	79.5	32 PH-FLH	24GSM32FLH
-32	50	2	1.1/2"	230.0	116.0	63.5	24 PH-FLH	32GSM24FLH
-32	50	2	2"	251.4	137.4	79.5	32 PH-FLH	32GSM32FLH

Details on flange kits see page 250.

Unless otherwise stated the coupling meets the pressure rating requirements of the respective international standard.

SAE FLH22

SAE 'O' ring flange high-pressure.

Code 62. 22° swept elbow.

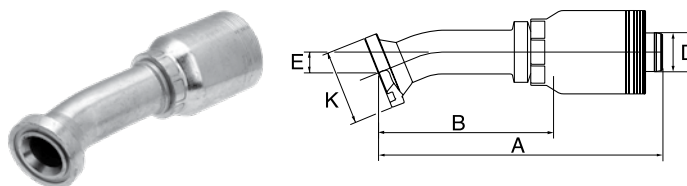

D				A B E K				KIT	REF.
-size	DN	"		mm	mm	mm	mm		GSM
-24	40	1.1/2	1.1/2"	243.0	148.4	18.0	63.5	24 PH-FLH	24GSM24FLH22M

Details on flange kits see page 250. / M: Medium drop per ISO 12151-3.

SAE FLH30

SAE 'O' ring flange high-pressure.

Code 62. 30° swept elbow.

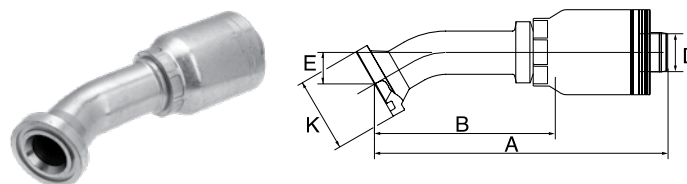

D				A B E K				KIT	REF.
-size	DN	"		mm	mm	mm	mm		GSM
-24	40	1.1/2	1.1/2"	240.0	144.8	30.0	63.5	24 PH-FLH	24GSM24FLH30M

Details on flange kits see page 250. / M: Medium drop per ISO 12151-3.

SAE FLH45

SAE 'O' ring flange high-pressure.

Code 62. 45° swept elbow.

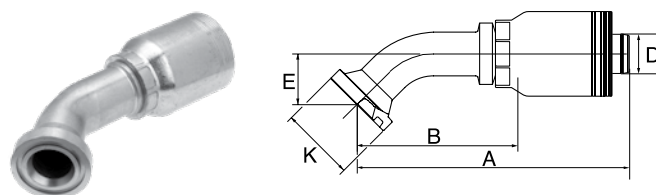

D				A B E K				KIT	REF.
-size	DN	"		mm	mm	mm	mm		GSM
-24	40	1.1/2	1.1/2"	232.0	137.0	44.0	63.5	24 PH-FLH	24GSM24FLH45M
-24	40	1.1/2	2"	241.0	146.0	56.0	79.5	32 PH-FLH	24GSM32FLH45M
-32	50	2	2"	297.0	182.5	63.0	79.5	32 PH-FLH	32GSM32FLH45-063

Details on flange kits see page 250. / M: Medium drop per ISO 12151-3.

Unless otherwise stated the coupling meets the pressure rating requirements of the respective international standard.

TABLE OF CONTENTS

ABOUT GATES

HYDRAULIC HOSE

HYDRAULIC HOSE COUPLINGS

ENGINEERING AND TECHNICAL DATA

SAE FLH60

SAE 'O' ring flange high-pressure.
Code 62. 60° swept elbow.

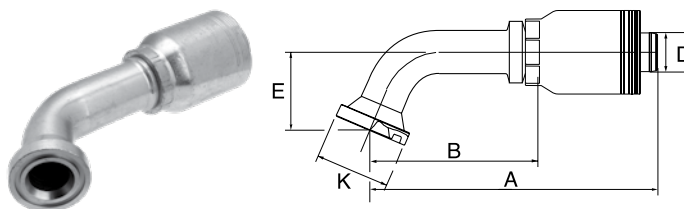

D			1.1/2"	A B E K				KIT	REF. GSM
-size	DN	"		mm	mm	mm	mm		
-24	40	1.1/2	1.1/2"	253.0	158.2	64.0	63.5	24 PH-FLH	24GSM24FLH60M

Details on flange kits see page 250. / M: Medium drop per ISO 12151-3.

SAE FLH90

SAE 'O' ring flange high-pressure.
Code 62. 90° swept elbow.

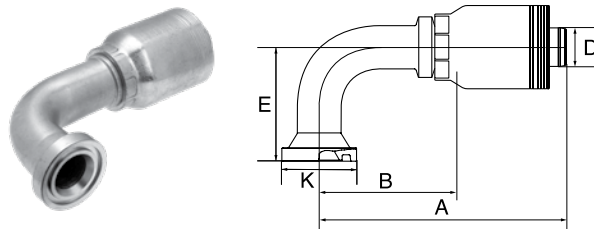

D			1.1/2"	A B E K				KIT	REF. GSM
-size	DN	"		mm	mm	mm	mm		
-24	40	1.1/2	1.1/2"	214.0	119.0	94.0	63.5	24 PH-FLH	24GSM24FLH90-094
-24	40	1.1/2	2"	214.0	118.9	120.0	79.5	32 PH-FLH	24GSM32FLH90S
-32	50	2	2"	264.0	150.0	138.0	79.5	32 PH-FLH	32GSM32FLH90M

Details on flange kits see page 250. / S: Short drop - M: Medium drop per ISO 12151-3.

FLC

Caterpillar type 'O' ring flange.

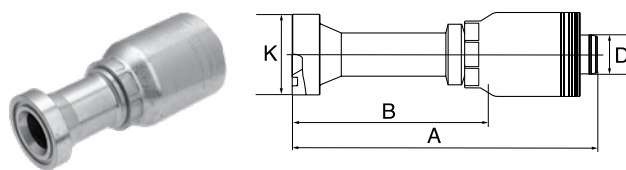

D			1.1/2"	A B K			REF. GSM
-size	DN	"		mm	mm	mm	
-24	40	1.1/2	1.1/2"	189.0	94.3	63.5	24GSM24FLC
-24	40	1.1/2	2"	200.0	105.0	79.5	24GSM32FLC
-32	50	2	2"	227.7	113.7	79.5	32GSM32FLC

-24 size is 42.0 MPa (6000 psi). / Note: FLC flanges are designed with a thicker flange head. The 14.2 mm flange dimension is frequently found on Caterpillar equipment. This flange lets the user utilise the Caterpillar flange clamp halves where practical when he replaces the hose assembly. At the user's option, standard Code 62 flanges and flange clamp halves can be used in place of the Caterpillar flanges and flange clamp halves. The standard Code 62 flange head thickness is 12.7 mm.

Unless otherwise stated the coupling meets the pressure rating requirements of the respective international standard.

FLC22

Caterpillar type 'O' ring flange.
22° swept elbow.

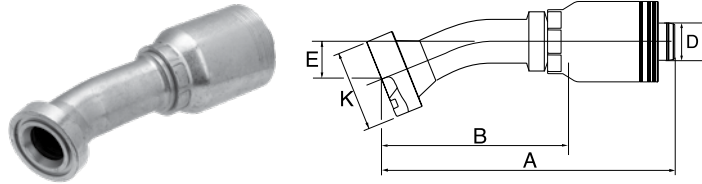

D				A B E K				REF.
-size	DN	"	1.1/2"	mm	mm	mm	mm	GSM
-24	40	1.1/2	1.1/2"	236.0	141.5	17.0	63.5	24GSM24FLC22-017

-24 size is 42.0 MPa (6000 psi). / Note: FLC flanges are designed with a thicker flange head. The 14.2 mm flange dimension is frequently found on Caterpillar equipment. This flange lets the user utilise the Caterpillar flange clamp halves where practical when he replaces the hose assembly. At the user's option, standard Code 62 flanges and flange clamp halves can be used in place of the Caterpillar flanges and flange clamp halves. The standard Code 62 flange head thickness is 12.7 mm.

FLC30

Caterpillar type 'O' ring flange.
30° swept elbow.

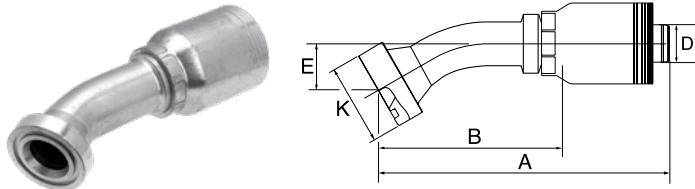

D				A B E K				REF.
-size	DN	"	1.1/2"	mm	mm	mm	mm	GSM
-24	40	1.1/2	1.1/2"	235.0	139.5	23.0	63.5	24GSM24FLC30-023

-24 size is 42.0 MPa (6000 psi). / Note: FLC flanges are designed with a thicker flange head. The 14.2 mm flange dimension is frequently found on Caterpillar equipment. This flange lets the user utilise the Caterpillar flange clamp halves where practical when he replaces the hose assembly. At the user's option, standard Code 62 flanges and flange clamp halves can be used in place of the Caterpillar flanges and flange clamp halves. The standard Code 62 flange head thickness is 12.7 mm.

FLC45

Caterpillar type 'O' ring flange.
45° swept elbow.

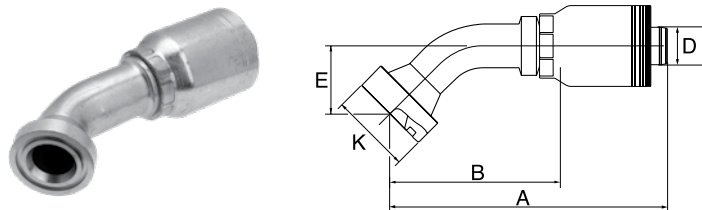

D				A B E K				REF.
-size	DN	"	1.1/2"	mm	mm	mm	mm	GSM
-24	40	1.1/2	1.1/2"	227.0	132.0	39.0	63.5	24GSM24FLC45-039
-32	50	2	2"	287.5	173.5	64.0	79.5	32GSM32FLC45-064

-24 size is 42.0 MPa (6000 psi). / Note: FLC flanges are designed with a thicker flange head. The 14.2 mm flange dimension is frequently found on Caterpillar equipment. This flange lets the user utilise the Caterpillar flange clamp halves where practical when he replaces the hose assembly. At the user's option, standard Code 62 flanges and flange clamp halves can be used in place of the Caterpillar flanges and flange clamp halves. The standard Code 62 flange head thickness is 12.7 mm.

Unless otherwise stated the coupling meets the pressure rating requirements of the respective international standard.

FLC90

Caterpillar type 'O' ring flange.
90° swept elbow.

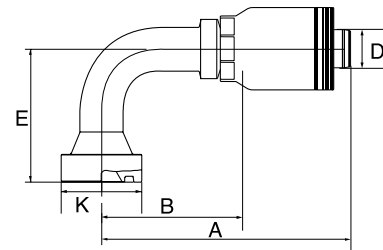

D				A B E K				REF.
-size	DN	"		mm	mm	mm	mm	GSM
-24	40	1.1/2	1.1/2"	214.1	119.1	87.0	63.5	24GSM24FLC90-087
-32	50	2	2"	264.5	150.5	130.0	79.5	32GSM32FLC90-130

-24 size is 42.0 MPa (6000 psi). / Note: FLC flanges are designed with a thicker flange head. The 14.2 mm flange dimension is frequently found on Caterpillar equipment. This flange lets the user utilise the Caterpillar flange clamp halves where practical when he replaces the hose assembly. At the user's option, standard Code 62 flanges and flange clamp halves can be used in place of the Caterpillar flanges and flange clamp halves. The standard Code 62 flange head thickness is 12.7 mm.

DIN 24° FDHORX

Female DIN 'O' ring swivel. 24° cone.
Heavy series.

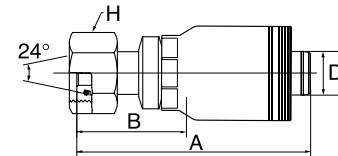

D				A B H			REF.
-size	DN	"		mm	mm	mm	GSM
-24	40	1.1/2	M52 x 2.0	180.0	85.0	60.0	24GSM38FDHORX

-24 size is 42.0 MPa (6000 psi).

DIN 24° FDHORX45

Female DIN 'O' ring swivel. 24° cone.
Heavy series. 45° swept elbow.

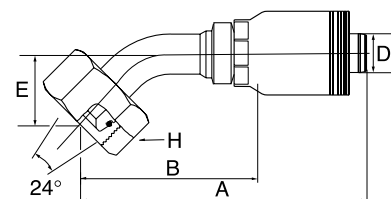

D				A B E H				REF.
-size	DN	"		mm	mm	mm	mm	GSM
-24	40	1.1/2	M52 x 2.0	236.9	141.9	44.0	60.0	24GSM38FDHORX45

-24 size is 42.0 MPa (6000 psi).

Unless otherwise stated the coupling meets the pressure rating requirements of the respective international standard.



DIN 24° FDHORX90

Female DIN 'O' ring swivel. 24° cone.
Heavy series. 90° swept elbow.

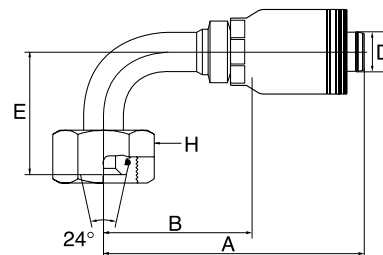

D			M52 x 2.0	A B E H				REF. GSM
-size	DN	"		mm	mm	mm	mm	
-24	40	1.1/2	M52 x 2.0	222.6	127.6	92.0	60.0	24GSM38FDHORX90

-24 size is 42.0 MPa (6000 psi).

NPTF MP

Male NPTF pipe.

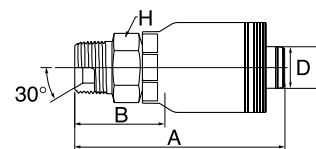

D			1.1/2" - 11.5 NPTF	A B H			REF. GSM
-size	DN	"		mm	mm	mm	
-24	40	1.1/2	1.1/2" - 11.5 NPTF	165.3	70.3	50.8	24GSM24MP
-32	50	2	2" - 11.5 NPTF	191.6	77.6	69.9	32GSM32MP

-24 size is 24.5 MPa (3500 psi); -32 size is 17.5 MPa (2500 psi). / Warning: Use only in NPTF connections. Do not use in oil field (API) connections. Blow apart of an oil field connection can result in serious injuries.

PLSOR

Male Press-Lok Super 'O' ring.

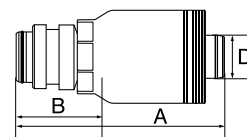

D			A B		REF. GSM
-size	DN	"	mm	mm	
-24	40	1.1/2	181.1	86.1	24GSM24PLSOR
-32	50	2	204.8	90.8	32GSM32PLSOR

Unless otherwise stated the coupling meets the pressure rating requirements of the respective international standard.

TABLE OF CONTENTS

ABOUT GATES

HYDRAULIC HOSE

HYDRAULIC HOSE COUPLINGS

ENGINEERING AND TECHNICAL DATA

NO-SKIVE FERRULES FOR SPIRAL WIRE HOSE

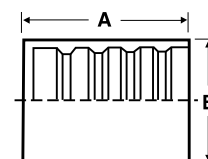

-size	D		A	B	REF.
	DN	"	mm	mm	GS
-6	10	3/8	36.3	31.8	6GS1F-4
-8	12	1/2	36.6	34.4	8GS1F-4
-10	16	5/8	47.8	41.7	10GS1F-4
-12	20	3/4	50.8	45.7	12GS1F-4
-16	25	1	56.4	52.6	16GS1F-4
-20	32	1.1/4	67.8	61.5	20GS1F-4
-20	32	1.1/4	72.9	67.8	20GS1F-6
-24	40	1.1/2	76.5	72.0	24GSP1F-4
-32	50	2	91.0	85.0	32GSP1F-4

Note -24 & -32: Use GSP1F-4 only for 4-spiral wire hose. For 6-spiral wire hose use 1-piece GSM coupling.

NO-SKIVE FERRULES FOR XPIRAL HOSE

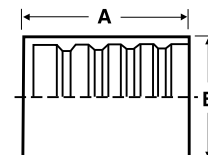

-size	D		A	B	REF.
	DN	"	mm	mm	GS
-6	10	3/8	30.5	26.9	6GS1F-2
-8	12	1/2	37.5	29.3	8GS1F-2
-10	16	5/8	35.6	33.7	10GS1F-2
-12	19	3/4	44.0	39.9	12GS1F-2
-16	25	1	52.3	49.3	16GS1F-4
-10	16	5/8	51.0	48.8	10GSID1F-4

Unless otherwise stated the coupling meets the pressure rating requirements of the respective international standard.

BSP FBSPORX

Female BSP 'O' ring swivel. 60° cone.

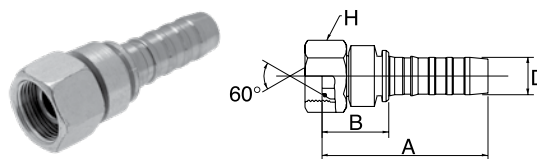

↻			🌀	↔			📏
D				A	B	H	REF.
-size	DN	"		mm	mm	mm	GS
-6	10	3/8	G 3/8" - 19 BSP	60.5	24.7	22.0	6GS6FBSPORX
-6	10	3/8	G 1/2" - 14 BSP	60.2	24.4	27.0	6GS8FBSPORX
-8	12	1/2	G 1/2" - 14 BSP	61.0	23.5	27.0	8GS8FBSPORX
-8	12	1/2	G 5/8" - 14 BSP	62.0	24.5	30.0	8GS10FBSPORX
-10	16	5/8	G 5/8" - 14 BSP	80.5	30.2	30.0	10GS10FBSPORX
-10	16	5/8	G 3/4" - 14 BSP	82.3	32.0	32.0	10GS12FBSPORX
-12	20	3/4	G 3/4" - 14 BSP	86.5	35.5	32.0	12GS12FBSPORX
-12	20	3/4	G 1" - 11 BSP	86.6	35.6	41.0	12GS16FBSPORX
-16	25	1	G 1" - 11 BSP	95.0	38.6	41.0	16GS16FBSPORX
-16	25	1	G 1.1/4" - 11 BSP	83.0	26.2	50.0	16GS20FBSPORX
-20	32	1.1/4	G 1.1/4" - 11 BSP	116.5	45.4	50.0	20GS20FBSPORX
-24	40	1.1/2	G 1.1/2" - 11 BSP	125.0	51.3	55.0	24GSP24FBSPORX
-32	50	2	G 2" - 11 BSP	153.0	61.0	70.0	32GSP32FBSPORX

-6 to -20 size are 42.0 MPa (6000 psi).

Unless otherwise stated the coupling meets the pressure rating requirements of the respective international standard.

BSP FBSPORX-RB

Female BSP 'O' ring swivel. 60° cone.
Rockbreaker version.

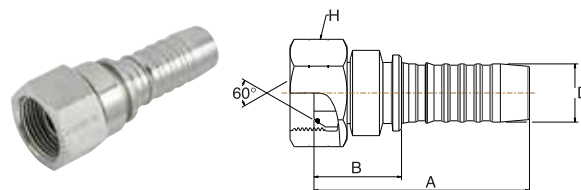

↻			🌀	↔			🔧
D				A	B	H	REF.
-size	DN	"		mm	mm	mm	GS
-16	25	1	G 1" - 11 BSP	95.0	38.6	41.0	16GS16FBSPORX-RB
-20	32	1.1/4	G 1.1/4" - 11 BSP	116.5	45.4	50.0	20GS20FBSPORX-RB

BSP FBSPORX45

Female BSP 'O' ring swivel. 60° cone.
45° swept elbow.

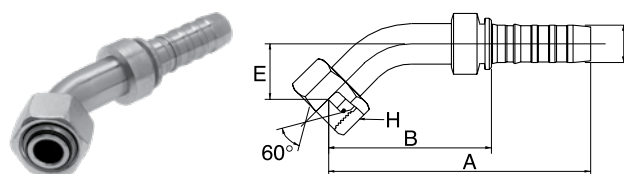

↻			🌀	↔				🔧
D				A	B	E	H	REF.
-size	DN	"		mm	mm	mm	mm	GS
-6	10	3/8	G 3/8" - 19 BSP	83.1	47.3	15.4	22.0	6GS6FBSPORX45
-6	10	3/8	G 1/2" - 14 BSP	87.0	51.2	19.3	27.0	6GS8FBSPORX45
-8	12	1/2	G 1/2" - 14 BSP	91.5	54.1	17.0	27.0	8GS8FBSPORX45
-10	16	5/8	G 5/8" - 14 BSP	118.0	67.7	21.3	30.0	10GS10FBSPORX45
-10	16	5/8	G 3/4" - 14 BSP	127.9	77.6	31.2	32.0	10GS12FBSPORX45
-12	20	3/4	G 3/4" - 14 BSP	134.4	83.4	28.3	32.0	12GS12FBSPORX45
-16	25	1	G 1" - 11 BSP	155.5	99.1	30.9	41.0	16GS16FBSPORX45
-20	32	1.1/4	G 1.1/4" - 11 BSP	191.1	120.0	37.5	50.0	20GS20FBSPORX45
-24	40	1.1/2	G 1.1/2" - 11 BSP	214.5	140.9	49.7	55.0	24GSP24FBSPORX45
-32	50	2	G 2" - 11 BSP	276.1	184.1	62.3	70.0	32GSP32FBSPORX45

-6 to -20 size are 42.0 MPa (6000 psi).

Unless otherwise stated the coupling meets the pressure rating requirements of the respective international standard.

BSP FBSPORX90

Female BSP 'O' ring swivel. 60° cone.
90° swept elbow.

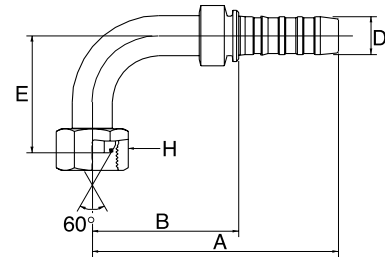

D			G	A B E H				REF. GS
-size	DN	"		mm	mm	mm	mm	
-6	10	3/8	G 3/8" - 19 BSP	78.0	42.2	32.0	22.0	6GS6FBSPORX90
-8	12	1/2	G 1/2" - 14 BSP	88.0	50.5	37.5	27.0	8GS8FBSPORX90
-10	16	5/8	G 5/8" - 14 BSP	112.5	62.2	46.0	30.0	10GS10FBSPORX90
-10	16	5/8	G 3/4" - 14 BSP	112.5	62.2	60.0	32.0	10GS12FBSPORX90
-12	20	3/4	G 3/4" - 14 BSP	126.0	75.0	60.0	32.0	12GS12FBSPORX90
-12	20	3/4	G 1" - 11 BSP	126.0	75.0	70.2	41.0	12GS16FBSPORX90
-16	25	1	G 1" - 11 BSP	151.0	94.6	70.0	41.0	16GS16FBSPORX90
-20	32	1.1/4	G 1.1/4" - 11 BSP	180.5	109.4	80.0	50.0	20GS20FBSPORX90
-24	40	1.1/2	G 1.1/2" - 11 BSP	194.6	121.0	100.0	55.0	24GSP24FBSPORX90
-32	50	1	G 2" - 11 BSP	254.7	162.7	129.1	70.0	32GSP32FBSPORX90

-6 to -20 size are 42.0 MPa (6000 psi).

BSP FBSPORX180

Female BSP 'O' ring swivel. 60° cone.
180° swept elbow.

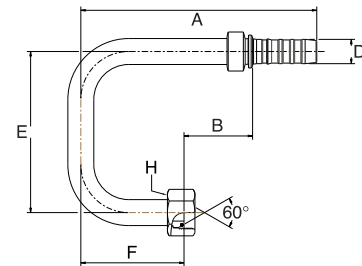

D			G	A B E F H					REF. GS
-size	DN	"		mm	mm	mm	mm	mm	
-12	20	3/4	3/4"	187.5	54.5	128.0	82.0	32.0	12GS12FBSPORX180

Size -12 is 42.0 MPa. (6000 psi)

Unless otherwise stated the coupling meets the pressure rating requirements of the respective international standard.

BSP MBSP

Male BSP Parallel. 60° inverted cone.

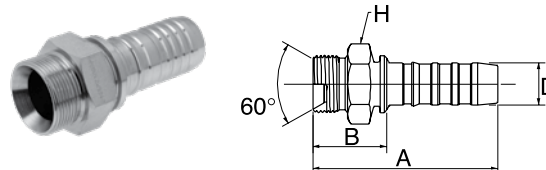

D				A	B	H	REF.
-size	DN	"		mm	mm	mm	GS
-6	10	3/8	G 3/8" - 19 BSP	63.0	27.2	22.0	6GS6MBSP
-6	10	3/8	G 1/2" - 14 BSP	68.0	32.2	27.0	6GS8MBSP
-8	12	1/2	G 1/2" - 14 BSP	67.5	30.0	27.0	8GS8MBSP
-10	16	5/8	G 5/8" - 14 BSP	84.0	33.7	30.0	10GS10MBSP
-10	16	5/8	G 3/4" - 14 BSP	85.0	34.7	32.0	10GS12MBSP
-12	20	3/4	G 3/4" - 14 BSP	85.0	34.7	32.0	12GS12MBSP
-12	20	3/4	G 1" - 11 BSP	90.0	39.0	41.0	12GS16MBSP
-16	25	1	G 1" - 11 BSP	98.0	41.2	41.0	16GS16MBSP
-20	32	1.1/4	G 1.1/4" - 11 BSP	118.0	46.9	50.0	20GS20MBSP

-6 to -20 size are 42.0 MPa (6000 psi).

BSP MBSP-RB

Male BSP Parallel. 60° inverted cone.
Rockbreaker version.

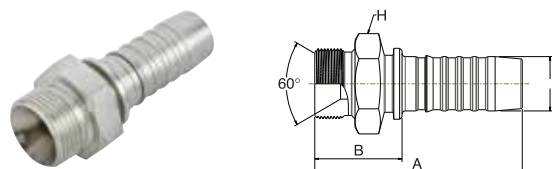

D				A	B	H	REF.
-size	DN	"		mm	mm	mm	GS
-12	20	3/4	G 3/4" - 14 BSP	85.0	34.0	32.0	12GS12MBSP-RB
-16	25	1	G 1" - 11 BSP	98.0	41.2	41.0	16GS16MBSP-RB
-20	32	1.1/4	G 1.1/4" - 11 BSP	118.0	46.9	50.0	20GS20MBSP-RB

-6 to -20 size are 42.0 MPa (6000 psi).

Unless otherwise stated the coupling meets the pressure rating requirements of the respective international standard.

JIC 37° FJX

Female JIC swivel. 37° inverted cone.

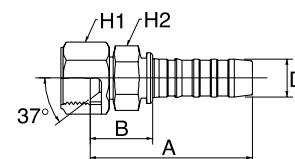

D				A B H1 H2				REF.
-size	DN	"		mm	mm	mm	mm	GS
-6	10	3/8	9/16" - 18 UNF	58.8	23.0	19.1	19.1	6GS6FJX
-6	10	3/8	3/4" - 16 UNF	63.8	28.0	22.2	19.1	6GS8FJX
-8	12	1/2	3/4" - 16 UNF	61.0	23.5	22.2	22.2	8GS8FJX
-8	12	1/2	7/8" - 14 UNF	62.0	24.5	27.0	22.2	8GS10FJX
-8	12	1/2	1.1/16" - 12 UN	62.0	24.5	31.8	22.2	8GS12FJX
-10	16	5/8	7/8" - 14 UNF	93.5	43.2	27.0	25.4	10GS10FJX
-10	16	5/8	1.1/16" - 12 UN	80.0	29.7	31.8	25.4	10GS12FJX
-12	20	3/4	7/8" - 14 UNF	84.4	33.4	28.6	27.0	12GS10FJX
-12	20	3/4	1.1/16" - 12 UN	83.2	32.2	31.8	28.6	12GS12FJX
-12	20	3/4	1.3/16" - 12 UN	85.9	34.9	34.9	28.6	12GS14FJX
-12	20	3/4	1.5/16" - 12 UN	85.4	34.4	38.1	28.6	12GS16FJX
-16	25	1	1.1/16" - 12 UN	92.5	35.7	34.9	34.9	16GS12FJX
-16	25	1	1.3/16" - 12 UN	92.2	35.4	38.1	34.9	16GS14FJX
-16	25	1	1.5/16" - 12 UN	93.0	36.6	38.1	38.1	16GS16FJX
-16	25	1	1.5/8" - 12 UN	98.2	41.8	50.8	38.1	16GS20FJX
-20	32	1.1/4	1.5/16" - 12 UN	113.0	41.9	41.3	44.5	20GS16FJX
-20	32	1.1/4	1.5/8" - 12 UN	119.2	48.1	50.8	47.6	20GS20FJX
-20	32	1.1/4	1.7/8" - 12 UN	117.6	46.5	60.3	47.6	20GS24FJX
-24	40	1.1/2	1.7/8" - 12 UN	124.0	50.4	60.0	55.0	24GSP24FJX
-32	50	2	2.1/2" - 12 UN	148.0	56.0	75.0	65.0	32GSP32FJX

-6 to -20 size are 42.0 MPa (6000 psi).

Unless otherwise stated the coupling meets the pressure rating requirements of the respective international standard.

TABLE OF CONTENTS
ABOUT GATES
HYDRAULIC HOSE
HYDRAULIC HOSE COUPLINGS
ENGINEERING AND TECHNICAL DATA

JIC 37° FJX45

Female JIC swivel. 37° inverted cone.
45° swept elbow.

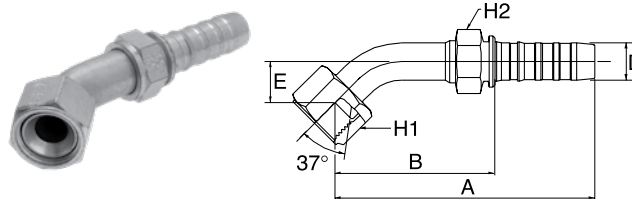

D				A B E H1 H2					REF.
-size	DN	"		mm	mm	mm	mm	mm	GS
-6	10	3/8	9/16" - 18 UNF	82.0	46.2	11.0	19.1	19.1	6GS6FJX45S
-6	10	3/8	3/4" - 16 UNF	93.0	57.2	15.0	22.2	19.1	6GS8FJX45S
-8	12	1/2	3/4" - 16 UNF	94.0	56.5	15.0	22.2	22.2	8GS8FJX45S
-8	12	1/2	7/8" - 14 UNF	91.0	53.5	16.0	27.0	22.2	8GS10FJX45S
-10	16	5/8	7/8" - 14 UNF	113.0	63.0	18.0	27.0	30.0	10GS10FJX45-018
-10	16	5/8	1.1/16" - 12 UN	122.0	71.7	21.0	31.8	25.4	10GS12FJX45S
-12	20	3/4	1.1/16" - 12 UN	130.0	79.0	21.0	31.8	28.6	12GS12FJX45S
-12	20	3/4	1.5/16" - 12 UN	137.0	86.0	24.0	38.1	28.6	12GS16FJX45S
-16	25	1	1.5/16" - 12 UN	152.0	95.6	24.0	38.1	38.1	16GS16FJX45S
-16	25	1	1.5/8" - 12 UN	164.0	107.6	25.0	50.8	38.1	16GS20FJX45S
-20	32	1.1/4	1.5/8" - 12 UN	180.0	108.9	38.0	50.8	47.6	20GS20FJX45-038
-24	40	1.1/2	1.7/8" - 12 UN	233.0	159.5	50.0	60.0	55.0	24GSP24FJX45-050
-32	50	2	2.1/2" - 12 UN	267.0	175.5	65.0	75.0	65.0	32GSP32FJX45-065

-6 to -20 size are 42.0 MPa (6000 psi). / S: Short drop per ISO 12151-5.

JIC 37° FJX90S

Female JIC swivel. 37° inverted cone.
90° swept elbow. Short drop.

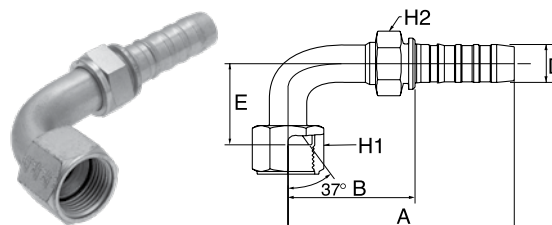

D				A B E H1 H2					REF.
-size	DN	"		mm	mm	mm	mm	mm	GS
-6	10	3/8	9/16" - 18 UNF	79.0	43.2	23.0	19.1	19.1	6GS6FJX90S
-8	12	1/2	3/4" - 16 UNF	86.0	48.6	29.0	22.2	22.2	8GS8FJX90S
-8	12	1/2	7/8" - 14 UNF	92.0	54.5	32.0	27.0	22.2	8GS10FJX90S
-8	12	1/2	1.1/16" - 12 UN	111.0	73.5	48.0	31.8	22.2	8GS12FJX90S
-10	16	5/8	7/8" - 14 UNF	111.0	43.3	36.0	27.0	30.0	10GS10FJX90-036
-12	20	3/4	1.1/16" - 12 UN	119.0	68.0	48.0	31.8	28.6	12GS12FJX90S
-12	20	3/4	1.5/16" - 12 UN	135.0	84.0	56.0	38.1	28.6	12GS16FJX90S
-16	25	1	1.5/16" - 12 UN	144.0	87.6	56.0	38.1	38.1	16GS16FJX90S
-20	32	1.1/4	1.5/8" - 12 UN	174.0	102.9	64.0	50.8	47.6	20GS20FJX90S

-6 to -20 size are 42.0 MPa (6000 psi). / S: Short drop per ISO 12151-5.

Unless otherwise stated the coupling meets the pressure rating requirements of the respective international standard.

JIC 37° FJX90M

Female JIC swivel. 37° inverted cone.
90° swept elbow. Medium drop.

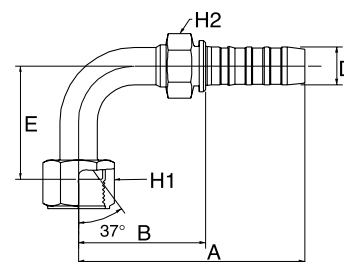

D				A B E H1 H2					REF.
-size	DN	"		mm	mm	mm	mm	mm	GS
-6	10	3/8	3/4" - 16 UNF	91.0	55.2	41.0	22.2	19.1	6GS8FJX90M
-8	12	1/2	3/4" - 16 UNF	92.0	54.6	41.0	22.2	22.2	8GS8FJX90M
-8	12	1/2	7/8" - 14 UNF	89.0	51.5	47.0	27.0	22.2	8GS10FJX90M
-10	16	5/8	7/8" - 14 UNF	107.0	57.0	47.0	27.0	30.0	10GS10FJX90M
-10	16	5/8	1.1/16" - 12 UN	121.0	70.7	58.0	31.8	25.4	10GS12FJX90M
-12	20	3/4	1.1/16" - 12 UN	119.0	68.0	58.0	31.8	28.6	12GS12FJX90M
-12	20	3/4	1.3/16" - 12 UN	141.0	90.0	60.0	34.9	28.6	12GS14FJX90-060
-12	20	3/4	1.5/16" - 12 UN	135.0	84.0	71.0	38.1	28.6	12GS16FJX90M
-16	25	1	1.5/16" - 12 UN	144.0	87.6	71.0	38.1	38.1	16GS16FJX90M
-20	32	1.1/4	1.5/8" - 12 UN	174.0	102.9	78.0	50.8	47.6	20GS20FJX90M
-24	40	1.1/2	1.7/8" - 12 UN	212.0	138.4	89.0	60.0	55.0	24GSP24FJX90-089
-32	50	2	2.1/2" - 12 UN	272.0	179.7	140.0	75.0	65.0	32GSP32FJX90M

-6 to -20 size are 42.0 MPa (6000 psi). / M: Medium drop per ISO 12151-5.

JIC 37° FJX90L

Female JIC swivel. 37° inverted cone.
90° swept elbow. Long drop.

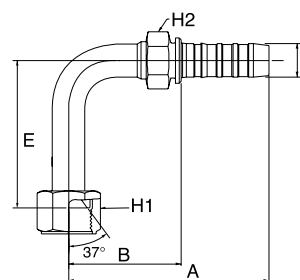

D				A B E H1 H2					REF.
-size	DN	"		mm	mm	mm	mm	mm	GS
-6	10	3/8	9/16" - 18 UNF	86.0	50.2	54.0	19.1	19.1	6GS6FJX90L
-8	12	1/2	3/4" - 16 UNF	92.0	54.6	64.0	22.2	22.2	8GS8FJX90L
-8	12	1/2	7/8" - 14 UNF	89.0	51.5	70.0	27.0	22.2	8GS10FJX90L
-12	20	3/4	1.1/16" - 12 UN	113.0	62.0	96.0	31.8	28.6	12GS12FJX90L
-16	25	1	1.5/16" - 12 UN	144.0	87.6	114.0	38.1	38.1	16GS16FJX90L
-16	25	1	1.5/8" - 12 UN	154.0	97.6	129.0	50.8	38.1	16GS20FJX90L
-20	32	1.1/4	1.5/8" - 12 UN	174.0	102.9	129.0	50.8	47.6	20GS20FJX90L

-6 to -20 size are 42.0 MPa (6000 psi). / L: Long drop per ISO 12151-5.

Unless otherwise stated the coupling meets the pressure rating requirements of the respective international standard.

TABLE OF CONTENTS

ABOUT GATES

HYDRAULIC HOSE

HYDRAULIC HOSE COUPLINGS

ENGINEERING AND TECHNICAL DATA

JIC 37° MJ

Male JIC parallel. 37° cone.

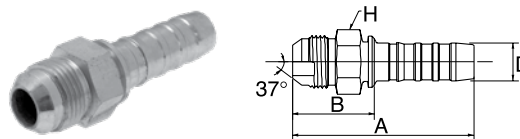

↔			🌀	↔			📏
D				A	B	H	REF.
-size	DN	"		mm	mm	mm	GS
-6	10	3/8	9/16" - 18 UNF	66.0	30.2	17.5	6GS6MJ
-6	10	3/8	3/4" - 16 UNF	70.0	34.2	20.6	6GS8MJ
-6	10	3/8	7/8" - 14 UNF	77.0	41.2	23.8	6GS10MJ
-8	12	1/2	3/4" - 16 UNF	72.0	34.5	20.6	8GS8MJ
-8	21	1/2	7/8" - 14 UNF	75.0	37.5	22.2	8GS10MJ
-10	16	5/8	7/8" - 14 UNF	92.0	41.7	23.8	10GS10MJ
-10	16	5/8	1.1/16" - 12 UN	94.0	43.7	27.0	10GS12MJ
-12	20	3/4	1.1/16" - 12 UN	93.0	42.0	28.6	12GS12MJ
-12	20	3/4	1.3/16" - 12 UN	94.0	43.0	31.8	12GS14MJ
-12	20	3/4	1.5/16" - 12 UN	96.0	45.0	33.3	12GS16MJ
-16	25	1	1.5/16" - 12 UN	104.0	47.2	34.9	16GS16MJ
-16	25	1	1.5/8" - 12 UN	108.5	51.7	44.5	16GS20MJ
-20	32	1.1/4	1.5/8" - 12 UN	125.0	53.9	44.5	20GS20MJ

-6 to -20 size are 42.0 MPa (6000 psi).

JIS FKX

Female Japanese swivel. 30° inverted cone.

Metric thread.

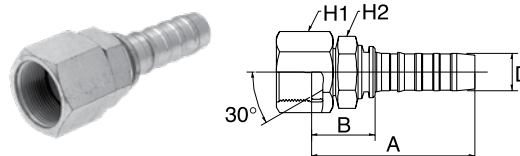

↔			🌀	↔				📏
D				A	B	H1	H2	REF.
-size	DN	"		mm	mm	mm	mm	GS
-8	12	1/2	M22 x 1.5	61.4	24.0	27.0	27.0	8GS8FKX
-10	16	5/8	M24 x 1.5	80.0	29.7	32.0	30.0	10GS10FKX
-12	20	3/4	M30 x 1.5	83.7	32.7	36.0	32.0	12GS12FKX
-16	25	1	M33 x 1.5	92.6	36.2	41.0	41.0	16GS16FKX

Unless otherwise stated the coupling meets the pressure rating requirements of the respective international standard.



SAE FFORX

Female SAE flat face 'O' ring swivel.

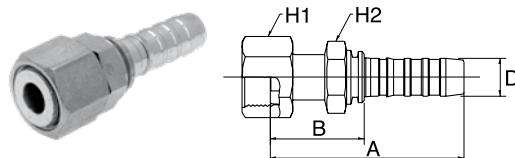

↻			🌀	↔				🔌
D				A	B	H1	H2	REF.
-size	DN	"		mm	mm	mm	mm	GS
-6	10	3/8	11/16" - 16 UN	69.0	33.2	22.0	22.0	6GS6FFORX
-6	10	3/8	13/16" - 16 UN	72.0	36.2	24.0	22.0	6GS8FFORX
-8	12	1/2	13/16" - 16 UN	71.5	34.0	24.0	27.0	8GS8FFORX
-8	12	1/2	1" - 14 UNS	78.0	40.5	30.0	27.0	8GS10FFORX
-8	12	1/2	1.3/16" - 12 UN	79.0	41.5	36.0	27.0	8GS12FFORX
-10	16	5/8	1" - 14 UNS	93.0	42.7	30.0	27.0	10GS10FFORX
-10	16	5/8	1.3/16" - 12 UN	95.0	44.7	36.0	30.0	10GS12FFORX
-12	20	3/4	1" - 14 UNS	97.0	46.0	30.0	30.0	12GS10FFORX
-12	20	3/4	1.3/16" - 12 UN	100.5	49.5	36.0	32.0	12GS12FFORX
-12	20	3/4	1.7/16" - 12 UN	103.0	52.0	41.0	32.0	12GS16FFORX
-12	20	3/4	1.11/16" - 12 UN	99.3	48.3	50.0	32.0	12GS20FFORX
-16	25	1	1.7/16" - 12 UN	111.0	54.6	41.0	41.0	16GS16FFORX
-16	25	1	1.11/16" - 12 UN	110.7	54.3	50.0	41.0	16GS20FFORX
-20	32	1.1/4	1.11/16" - 12 UN	128.0	56.9	50.0	50.0	20GS20FFORX
-20	32	1.1/4	2" - 12 UN	130.1	58.9	50.0	60.0	20GS24FFORX
-24	40	1.1/2	2" - 12 UN	137.0	63.4	60.0	55.0	24GSP24FFORX

-6 to -20 size are 42.0 MPa (6000 psi).

Unless otherwise stated the coupling meets the pressure rating requirements of the respective international standard.

TABLE OF CONTENTS

ABOUT GATES

HYDRAULIC HOSE

HYDRAULIC HOSE COUPLINGS

ENGINEERING AND TECHNICAL DATA

SAE FFORX45

Female SAE flat face 'O' ring swivel.
45° swept elbow.

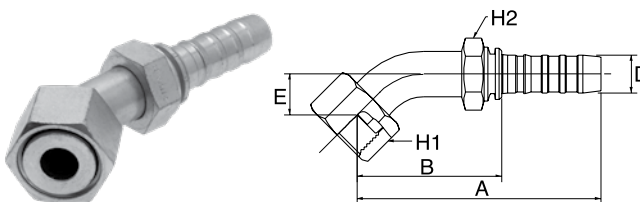

D				A	B	E	H1	H2	REF.
-size	DN	"		mm	mm	mm	mm	mm	GS
-6	10	3/8	11/16" - 16 UN	82.0	46.2	11.0	22.0	22.0	6GS6FFORX45S
-6	10	3/8	13/16" - 16 UN	93.0	57.2	15.0	24.0	22.0	6GS8FFORX45S
-8	12	1/2	13/16" - 16 UN	94.0	56.5	15.0	24.0	27.0	8GS8FFORX45S
-8	12	1/2	1" - 14 UNS	99.0	61.5	16.0	30.0	27.0	8GS10FFORX45S
-10	16	5/8	1" - 14 UNS	111.0	60.7	16.0	30.0	30.0	10GS10FFORX45S
-12	20	3/4	1.3/16" - 12 UN	125.0	74.0	21.0	36.0	32.0	12GS12FFORX45S
-12	20	3/4	1.7/16" - 12 UN	137.0	86.0	24.0	41.0	32.0	12GS16FFORX45S
-16	25	1	1.7/16" - 12 UN	144.0	87.6	24.0	41.0	41.0	16GS16FFORX45S
-16	25	1	1.11/16" - 12 UN	164.0	107.6	25.0	50.0	41.0	16GS20FFORX45S
-20	32	1.1/4	1.11/16" - 12 UN	180.0	108.9	32.0	50.0	50.0	20GS20FFORX45-032

-6 to -20 size are 42.0 MPa (6000 psi). / S: Short drop per ISO 12151-1.

Unless otherwise stated the coupling meets the pressure rating requirements of the respective international standard.

SAE FFORX90S

Female SAE flat face 'O' ring swivel.
90° swept elbow. Short drop.

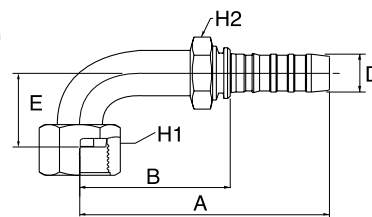

D				A, B, E, H1, H2					REF.
-size	DN	"		mm	mm	mm	mm	mm	GS
-6	10	3/8	11/16" - 16 UN	78.0	42.2	23.0	22.0	22.0	6GS6FFORX90S
-8	12	1/2	13/16" - 16 UN	86.0	48.5	29.0	24.0	27.0	8GS8FFORX90S
-8	12	1/2	1" - 14 UNS	101.0	63.4	32.0	30.0	24.0	8GS10FFORX90S
-8	12	1/2	1.3/16" - 12 UN	107.0	69.5	48.0	36.0	27.0	8GS12FFORX90S
-10	16	5/8	1" - 14 UNS	106.6	56.3	32.0	30.0	30.0	10GS10FFORX90S
-12	20	3/4	1" - 14 UNS	111.0	60.0	32.0	30.0	32.0	12GS10FFORX90S
-12	20	3/4	1.3/16" - 12 UN	128.0	77.0	48.0	36.0	32.0	12GS12FFORX90S
-12	20	3/4	1.7/16" - 12 UN	137.0	86.0	56.0	41.0	32.0	12GS16FFORX90S
-16	25	1	1.7/16" - 12 UN	144.0	87.6	56.0	41.0	41.0	16GS16FFORX90S
-16	25	1	1.11/16" - 12 UN	151.1	94.7	64.0	50.0	41.0	16GS20FFORX90S
-20	32	1.1/4	1.11/16" - 12 UN	172.0	100.9	64.0	50.0	50.0	20GS20FFORX90S
-20	32	1.1/4	2" - 12 UN	172.0	100.9	64.0	60.0	50.0	20GS24FFORX90-064

-6 to -20 size are 42.0 MPa (6000 psi). / S: Short drop per ISO 12151-1.

Unless otherwise stated the coupling meets the pressure rating requirements of the respective international standard.

TABLE OF CONTENTS

ABOUT GATES

HYDRAULIC HOSE

HYDRAULIC HOSE COUPLINGS

ENGINEERING AND TECHNICAL DATA

SAE FFORX90M

Female SAE flat face 'O' ring swivel.
90° swept elbow. Medium drop.

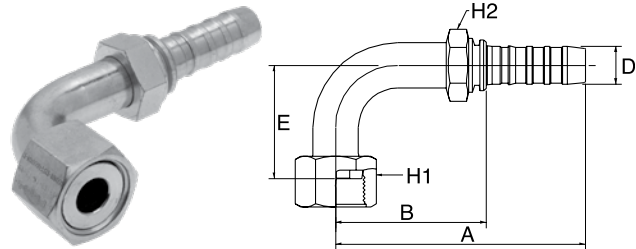

↔			🌀	↔					🌀
D				A	B	E	H1	H2	REF.
-size	DN	"		mm	mm	mm	mm	mm	GS
-6	10	3/8	11/16" - 16 UN	85.0	49.2	38.0	22.0	22.0	6GS6FFORX90M
-6	10	3/8	13/16" - 16 UN	85.0	49.2	41.0	24.0	22.0	6GS8FFORX90M
-8	12	1/2	13/16" - 16 UN	86.0	48.4	41.0	24.0	24.0	8GS8FFORX90M
-8	12	1/2	1.3/16" - 12 UN	101.0	63.5	47.0	30.0	27.0	8GS10FFORX90M
-10	16	5/8	1" - 14 UNS	107.0	56.7	47.0	30.0	30.0	10GS10FFORX90M
-12	20	3/4	1.3/16" - 12 UN	128.0	77.0	58.0	36.0	32.0	12GS12FFORX90M
-16	25	1	1.7/16" - 12 UN	144.0	87.6	71.0	41.0	41.0	16GS16FFORX90M
-16	25	1	1.11/16" - 12 UN	153.6	97.2	78.0	50.0	41.0	16GS20FFORX90M
-20	32	1.1/4	1.11/16" - 12 UN	172.0	100.9	78.0	50.0	50.0	20GS20FFORX90M

-6 to -20 size are 42.0 MPa (6000 psi). / M: Medium drop per ISO 12151-1.

SAE FFORX90L

Female SAE flat face 'O' ring swivel.
90° swept elbow. Long drop.

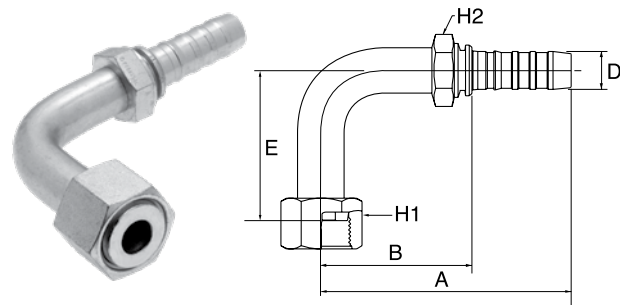

↔			🌀	↔					🌀
D				A	B	E	H1	H2	REF.
-size	DN	"		mm	mm	mm	mm	mm	GS
-6	10	3/8	11/16" - 16 UN	85.0	49.2	54.0	22.0	22.0	6GS6FFORX90L
-8	12	1/2	13/16" - 16 UN	86.0	48.5	83.0	24.0	27.0	8GS8FFORX90-083
-10	16	5/8	1" - 14 UNS	112.9	62.6	70.0	30.0	30.0	10GS10FFORX90L
-12	20	3/4	1.3/16" - 12 UN	128.0	77.0	96.0	36.0	32.0	12GS12FFORX90L
-16	25	1	1.7/16" - 12 UN	144.0	87.6	114.0	41.0	41.0	16GS16FFORX90L
-20	32	1.1/4	1.11/16" - 12 UN	172.0	100.9	129.0	50.0	50.0	20GS20FFORX90L

-6 to -20 size are 42.0 MPa (6000 psi). / L: Long drop per ISO 12151-1.

Unless otherwise stated the coupling meets the pressure rating requirements of the respective international standard.

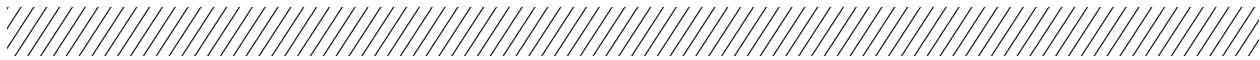

SAE MFFOR

Male SAE flat face 'O' ring.

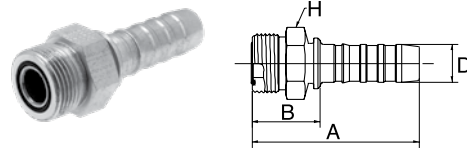

D				A	B	H	REF.
-size	DN	"		mm	mm	mm	GS
-6	10	3/8	11/16" - 16 UN	64.0	28.2	19.0	6GS6MFFOR
-8	12	1/2	13/16" - 16 UN	68.0	30.5	22.0	8GS8MFFOR
-10	16	5/8	1" - 14 UN	86.9	36.6	27.0	10GS10MFFOR
-12	20	3/4	1.3/16" - 12 UN	89.0	38.0	32.0	12GS12MFFOR
-12	20	3/4	1.7/16" - 12 UN	95.0	44.0	41.0	12GS16MFFOR
-16	25	1	1.7/16" - 12 UN	102.0	45.2	41.0	16GS16MFFOR
-20	32	1.1/4	1.11/16" - 12 UN	120.0	48.9	46.0	20GS20MFFOR

-6 to -20 size are 42.0 MPa (6000 psi).

SAE FL

SAE 'O' ring flange. Code 61.

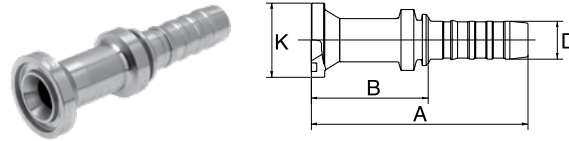

D				A	B	K	KIT	REF.
-size	DN	"		mm	mm	mm		GS
-6	10	3/8	1/2"	90.0	54.2	30.2	8 PA-FL	6GS8FL
-8	12	1/2	1/2"	93.0	55.5	30.2	8 PA-FL	8GS8FL
-8	12	1/2	3/4"	98.0	60.5	38.1	12 PA-FL	8GS12FL
-10	16	5/8	3/4"	109.0	58.7	38.1	12 PA-FL	10GS12FL
-12	20	3/4	1/2"	112.0	61.0	30.2	8 PA-FL	12GS8FL
-12	20	3/4	3/4"	111.0	60.0	38.1	12 PA-FL	12GS12FL
-12	20	3/4	1"	111.0	60.0	44.5	16 PA-FL	12GS16FL
-12	20	3/4	1.1/4"	111.0	60.0	50.8	20 PA-FL	12GS20FL
-16	25	1	1"	125.0	68.6	44.5	16 PA-FL	16GS16FL
-16	25	1	1.1/4"	125.0	68.2	50.8	20 PA-FL	16GS20FL
-16	25	1	1.1/2"	215.0	68.2	60.3	24 PA-FL	16GS24FL
-20	32	1.1/4	1"	136.0	64.9	44.5	16 PA-FL	20GS16FL
-20	32	1.1/4	1.1/4"	146.0	74.9	50.8	20 PA-FL	20GS20FL
-20	32	1.1/4	1.1/2"	160.0	88.9	60.3	24 PA-FL	20GS24FL
-24	40	1.1/2	1.1/2"	152.9	79.3	60.3	24 PA-FL	24GSP24FL
-24	40	1.1/2	2"	152.9	79.3	71.4	32 PA-FL	24GSP32FL
-32	50	2	2"	159.3	67.3	71.4	32 PA-FL	32GSP32FL

Code 61: -16 size is 35.0 MPa (5000 psi). / Details on flange kits see page 250.

Unless otherwise stated the coupling meets the pressure rating requirements of the respective international standard.

SAE FL22

SAE 'O' ring flange. Code 61.
22° swept elbow.

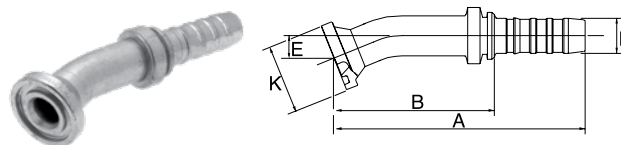

↔			⊕	↔					⊕
D				A	B	E	K	KIT	REF.
-size	DN	"		mm	mm	mm	mm		GS
-8	12	1/2	1/2"	96.0	58.5	9.0	30.2	8 PA-FL	8GS8FL22M
-12	20	3/4	3/4"	131.0	80.0	11.0	38.1	12 PA-FL	12GS12FL22M
-12	20	3/4	1"	133.0	82.0	14.0	44.5	16 PA-FL	12GS16FL22M
-16	25	1	1"	155.0	98.6	14.0	44.5	16 PA-FL	16GS16FL22M
-16	25	1	1.1/4"	168.0	111.4	15.0	50.8	20 PA-FL	16GS20FL22M
-20	32	1.1/4	1.1/4"	178.0	106.9	15.0	50.8	20 PA-FL	20GS20FL22M
-20	32	1.1/4	1.1/2"	186.0	114.9	18.0	60.3	24 PA-FL	20GS24FL22M

Code 61: -16 size is 35.0 MPa (5000 psi). / M: Medium drop per ISO 12151-3. / Details on flange kits see page 250.

SAE FL30

SAE 'O' ring flange. Code 61.
30° swept elbow.

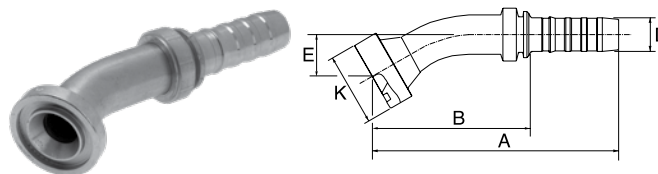

↔			⊕	↔					⊕
D				A	B	E	K	KIT	REF.
-size	DN	"		mm	mm	mm	mm		GS
-12	20	3/4	3/4"	129.0	78.0	16.0	38.1	12 PA-FL	12GS12FL30M
-12	20	3/4	1"	121.0	70.0	19.0	44.5	16 PA-FL	12GS16FL30M
-16	25	1	1"	153.0	96.6	19.0	44.5	16 PA-FL	16GS16FL30M
-16	25	1	1.1/4"	166.0	109.1	22.0	50.8	20 PA-FL	16GS20FL30M
-20	32	1.1/4	1.1/4"	176.0	104.9	22.0	50.8	20 PA-FL	20GS20FL30M
-20	32	1.1/4	1.1/2"	182.0	110.9	30.0	60.3	24 PA-FL	20GS24FL30M
-24	40	1.1/2	1.1/2"	209.0	135.2	25.0	60.3	24 PA-FL	24GSP24FL30S

Code 61: -16 size is 35.0 MPa (5000 psi). / S: Short drop - M: Medium drop per ISO 12151-3. / Details on flange kits see page 250.

Unless otherwise stated the coupling meets the pressure rating requirements of the respective international standard.

SAE FL45

SAE 'O' ring flange. Code 61.
45° swept elbow. Meets ISO 12151-3.

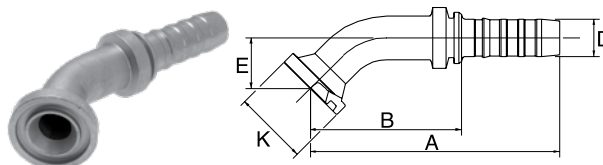

↻			☰	↔					☰
D				A	B	E	K	KIT	REF.
-size	DN	"		mm	mm	mm	mm		GS
-6	10	3/8	1/2"	93.0	57.2	19.0	30.2	8 PA-FL	6GS8FL45M
-8	12	1/2	1/2"	94.0	56.5	19.0	30.2	8 PA-FL	8GS8FL45M
-8	12	1/2	3/4"	101.0	63.5	26.0	38.1	12 PA-FL	8GS12FL45M
-10	16	5/8	3/4"	127.0	76.7	26.0	38.1	12 PA-FL	10GS12FL45M
-12	20	3/4	3/4"	124.0	73.0	26.0	38.1	12 PA-FL	12GS12FL45M
-12	20	3/4	1"	126.0	75.0	28.0	44.5	16 PA-FL	12GS16FL45S
-16	25	1	1"	147.0	90.6	32.0	44.5	16 PA-FL	16GS16FL45M
-16	25	1	1.1/4"	158.0	100.8	38.0	50.8	20 PA-FL	16GS20FL45M
-20	32	1.1/4	1"	163.0	91.9	32.0	44.5	16 PA-FL	20GS16FL45M
-20	32	1.1/4	1.1/4"	170.0	98.9	32.0	50.8	20 PA-FL	20GS20FL45S
-20	32	1.1/4	1.1/2"	176.0	104.9	38.0	60.3	24 PA-FL	20GS24FL45S
-24	40	1.1/2	1.1/2"	202.0	128.6	38.0	60.3	24 PA-FL	24GSP24FL45S
-24	40	1.1/2	1.1/2"	200.0	126.3	52.0	71.4	32 PA-FL	24GSP32FL45S
-32	50	2	2"	257.0	165.0	66.0	71.4	32 PA-FL	32GSP32FL45-066

Code 61: -16 size is 35.0 MPa (5000 psi). / S: Short drop - M: Medium drop per ISO 12151-3. / Details on flange kits see page 250.

SAE FL60

SAE 'O' ring flange. Code 61.
60° swept elbow.

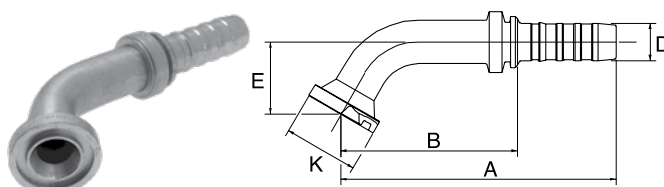

↻			☰	↔					☰
D				A	B	E	K	KIT	REF.
-size	DN	"		mm	mm	mm	mm		GS
-8	12	1/2	1/2"	104.0	66.5	27.0	30.2	8 PA-FL	8GS8FL60M
-12	20	3/4	3/4"	137.0	86.0	37.0	38.1	12 PA-FL	12GS12FL60M
-12	20	3/4	1"	136.0	85.0	44.0	44.5	16 PA-FL	12GS16FL60M
-16	25	1	1"	157.0	100.6	44.0	44.5	16 PA-FL	16GS16FL60M
-16	25	1	1.1/4"	157.0	100.2	55.0	50.8	20 PA-FL	16GS20FL60M
-20	32	1.1/4	1.1/4"	187.0	115.9	55.0	50.8	20 PA-FL	20GS20FL60M
-20	32	1.1/4	1.1/2"	195.0	123.9	64.0	60.3	24 PA-FL	20GS24FL60M
-24	40	1.1/2	1.1/2"	231.0	157.5	53.0	60.3	24 PA-FL	24GSP24FL60S

Code 61: -16 size is 35.0 MPa (5000 psi). / S: Short drop - M: Medium drop per ISO 12151-3. / Details on flange kits see page 250.

Unless otherwise stated the coupling meets the pressure rating requirements of the respective international standard.

TABLE OF CONTENTS

ABOUT GATES

HYDRAULIC HOSE

HYDRAULIC HOSE COUPLINGS

ENGINEERING AND TECHNICAL DATA

SAE FL67

SAE 'O' ring flange. Code 61.
67° swept elbow.

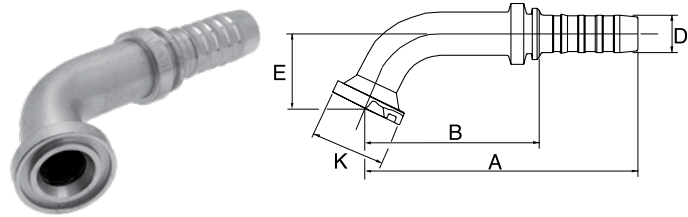

↔			⊕	↔				⊕	REF.
D				A	B	E	K	KIT	GS
-size	DN	"		mm	mm	mm	mm		
-12	20	3/4	1"	129.0	78.0	51.0	44.5	16 PA-FL	12GS16FL67M
-16	25	1	1"	151.0	94.6	51.0	44.5	16 PA-FL	16GS16FL67M
-16	25	1	1.1/4"	148.0	91.2	64.0	50.8	20 PA-FL	16GS20FL67M
-20	32	1.1/4	1.1/4"	179.0	107.7	64.0	50.8	20 PA-FL	20GS20FL67M

Code 61: -16 size is 35.0 MPa (5000 psi). / M: Medium drop per ISO 12151-3. / Details on flange kits see page 250.

SAE FL90S

SAE 'O' ring flange. Code 61.
90° swept elbow. Short drop.

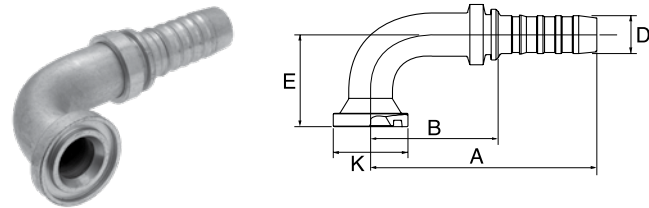

↔			⊕	↔				⊕	REF.
D				A	B	E	K	KIT	GS
-size	DN	"		mm	mm	mm	mm		
-12	20	3/4	1"	128.0	77.0	61.0	44.5	16 PA-FL	12GS16FL90S
-16	25	1	1"	135.0	78.6	61.0	44.5	16 PA-FL	16GS16FL90S
-16	25	1	1.1/4"	134.0	76.8	68.0	50.8	20 PA-FL	16GS20FL90S
-16	25	1	1.1/2"	134.0	77.2	81.0	60.3	24 PA-FL	16GS24FL90S
-20	32	1.1/4	1.1/4"	165.0	93.9	68.0	50.8	20 PA-FL	20GS20FL90S
-20	32	1.1/4	1.1/2"	166.0	94.9	81.0	60.3	24 PA-FL	20GS24FL90S
-24	40	1.1/2	1.1/2"	184.0	109.9	81.0	60.3	24 PA-FL	24GSP24FL90S

Code 61: -16 size is 35.0 MPa (5000 psi). / S: Short drop per ISO 12151-3. / Details on flange kits see page 250.

Unless otherwise stated the coupling meets the pressure rating requirements of the respective international standard.

SAE FL90M

SAE 'O' ring flange. Code 61.
90° swept elbow. Medium drop.

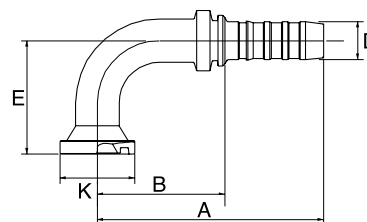

D				A	B	E	K	KIT	REF.
-size	DN	"		mm	mm	mm	mm		GS
-6	10	3/8	1/2"	87.0	51.2	40.0	30.2	8 PA-FL	6GS8FL90M
-8	12	1/2	1/2"	88.0	50.5	40.0	30.2	8 PA-FL	8GS8FL90M
-8	12	1/2	3/4"	88.0	50.4	58.0	38.1	12 PA-FL	8GS12FL90M
-10	16	5/8	3/4"	110.0	59.7	58.0	38.1	12 PA-FL	10GS12FL90M
-12	20	3/4	1/2"	122.0	71.0	50.0	30.2	8 PA-FL	12GS8FL90-050
-12	20	3/4	3/4"	112.0	61.0	58.0	38.1	12 PA-FL	12GS12FL90M
-12	20	3/4	1"	128.0	77.0	70.0	44.5	16 PA-FL	12GS16FL90M
-16	25	1	3/4"	134.9	129.0	57.9	38.1	12 PA-FL	16GS12FL90
-16	25	1	1"	135.0	78.6	70.0	44.5	16 PA-FL	16GS16FL90M
-16	25	1	1.1/4"	134.0	76.8	90.0	50.8	20 PA-FL	16GS20FL90M
-16	25	1	1.1/4"	145.0	88.1	59.9	60.5	24 PA-FL	16GS24FL90-060
-20	32	1.1/4	1"	160.0	88.9	70.0	44.5	16 PA-FL	20GS16FL90M
-20	32	1.1/4	1.1/4"	166.0	94.9	90.0	50.8	20 PA-FL	20GS20FL90M
-20	32	1.1/4	1.1/2"	165.0	93.9	118.0	60.3	24 PA-FL	20GS24FL90-118
-24	40	1.1/2	2"	175.0	101.9	80.0	71.4	32 PA-FL	24GSP32FL90-080
-32	50	2	2"	222.0	130.1	114.0	71.4	32 PA-FL	32GSP32FL90-114

Code 61: -16 size is 35.0 MPa (5000 psi). / M: Medium drop per ISO 12151-3. / Details on flange kits see page 250.

Unless otherwise stated the coupling meets the pressure rating requirements of the respective international standard.

TABLE OF CONTENTS

ABOUT GATES

HYDRAULIC HOSE

HYDRAULIC HOSE COUPLINGS

ENGINEERING AND TECHNICAL DATA

SAE FL90L

SAE 'O' ring flange. Code 61.
90° swept elbow. Long drop.

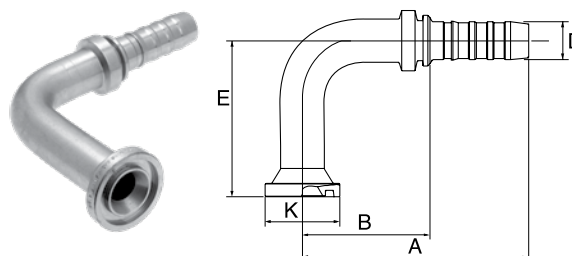

D				A	B	E	K	KIT	REF.
-size	DN	"		mm	mm	mm	mm		GS
-10	16	5/8	3/4"	110.0	59.7	100.0	38.1	12 PA-FL	10GS12FL90-100
-12	20	3/4	3/4"	122.0	71.0	100.0	38.1	12 PA-FL	12GS12FL90-100
-12	20	3/4	3/4"	122.0	71.0	125.0	38.1	12 PA-FL	12GS12FL90-125
-12	20	3/4	3/4"	116.0	65.0	150.0	38.1	12 PA-FL	12GS12FL90-150
-12	20	3/4	1"	116.0	65.0	100.0	44.5	16 PA-FL	12GS16FL90-100
-16	25	1	1"	135.0	78.6	100.0	44.5	16 PA-FL	16GS16FL90-100
-16	25	1	1"	134.0	77.6	120.0	44.5	16 PA-FL	16GS16FL90-120
-16	25	1	1"	144.0	87.4	150.0	44.5	16 PA-FL	16GS16FL90-150
-20	32	1.1/4	1"	160.0	88.9	215.0	44.5	16 PA-FL	20GS16FL90-215
-20	32	1.1/4	1.1/4"	166.0	94.9	168.0	50.8	20 PA-FL	20GS20FL90-168

Code 61: -16 size is 35.0 MPa (5000 psi); -20: 28.0 MPa (4000 psi). / Details on flange kits see page 250.

SAE FLH

SAE 'O' ring flange high-pressure.
Code 62.

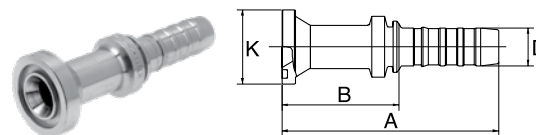

D				A	B	K	KIT	KIT	REF.
-size	DN	"		mm	mm	mm			GS
-8	12	1/2	1/2"	93.0	55.5	31.8	8 PH-FLH	8FLHCFM	8GS8FLH
-8	12	1/2	3/4"	93.0	55.5	41.3	12 PH-FLH	12FLHCFM	8GS12FLH
-10	16	5/8	1/2"	109.0	58.7	31.8	8 PH-FLH		10GS8FLH
-10	16	5/8	3/4"	109.0	58.7	41.3	12 PH-FLH	12FLHCFM	10GS12FLH
-12	20	3/4	3/4"	114.0	63.0	41.3	12 PH-FLH	12FLHCFM	12GS12FLH
-12	20	3/4	1"	114.0	63.0	47.6	16 PH-FLH	16FLHCFM	12GS16FLH
-16	25	1	3/4"	129.0	72.6	41.3	12 PH-FLH		16GS12FLH
-16	25	1	1"	125.0	68.6	47.6	16 PH-FLH	16FLHCFM	16GS16FLH
-16	25	1	1.1/4"	125.0	68.2	54.0	20 PH-FLH	20FLHCFM	16GS20FLH
-20	32	1.1/4	1"	163.0	91.9	47.6	16 PH-FLH		20GS16FLH
-20	32	1.1/4	1.1/4"	146.0	74.9	54.0	20 PH-FLH	20FLHCFM	20GS20FLH
-20	32	1.1/4	1.1/2"	160.0	88.9	63.5	24 PH-FLH	24FLHCFM	20GS24FLH

Details on flange kits see page 250.

Unless otherwise stated the coupling meets the pressure rating requirements of the respective international standard.

SAE FLH22

SAE 'O' ring flange high-pressure.
Code 62. 22° swept elbow.

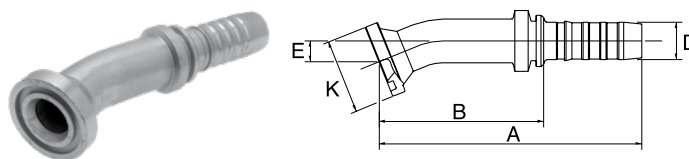

D				A	B	E	K	KIT	KIT	REF.
-size	DN	"		mm	mm	mm	mm			GS
-12	20	3/4	3/4"	131.0	80.0	11.0	41.3	12 PH-FLH	12FLHCFM	12GS12FLH22M
-16	25	1	1"	155.0	98.6	14.0	47.6	16 PH-FLH	16FLHCFM	16GS16FLH22M
-20	32	1.1/4	1.1/4"	186.0	114.9	15.0	54.0	20 PH-FLH		20GS20FLH22M

M: Medium drop per ISO 12151-3. / Details on flange kits see page 250.

SAE FLH30

SAE 'O' ring flange high-pressure.
Code 62. 30° swept elbow.

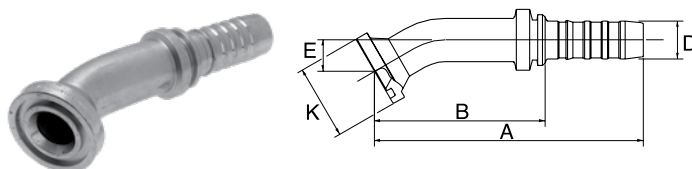

D				A	B	E	K	KIT	KIT	REF.
-size	DN	"		mm	mm	mm	mm			GS
-16	25	1	1"	153.0	96.6	19.0	47.6	16 PH-FLH	16FLHCFM	16GS16FLH30M
-16	25	1	1.1/4"	166.0	109.1	22.0	54.0	20 PH-FLH	20FLHCFM	16GS20FLH30M
-20	32	1.1/4	1.1/4"	184.0	112.9	22.0	54.0	20 PH-FLH		20GS20FLH30M
-20	32	1.1/4	1.1/2"	184.0	112.9	30.0	63.5	24 PH-FLH	24FLHCFM	20GS24FLH30M

M: Medium drop per ISO 12151-3. / Details on flange kits see page 250.

Unless otherwise stated the coupling meets the pressure rating requirements of the respective international standard.

TABLE OF CONTENTS

ABOUT GATES

HYDRAULIC HOSE

HYDRAULIC HOSE COUPLINGS

ENGINEERING AND TECHNICAL DATA

SAE FLH45

SAE 'O' ring flange high-pressure.
Code 62. 45° swept elbow.

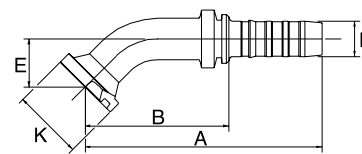

D				A	B	E	K	KIT	KIT	REF.
-size	DN	"		mm	mm	mm	mm			GS
-8	12	1/2	1/2"	94.0	56.5	19.0	31.8	8 PH-FLH	8FLHCFM	8GS8FLH45M
-8	12	1/2	3/4"	101.0	63.5	26.0	41.3	12 PH-FLH	12FLHCFM	8GS12FLH45M
-10	16	5/8	1/2"	115.0	64.7	19.0	31.8	8 PH-FLH		10GS8FLH45M
-10	16	5/8	3/4"	127.0	76.7	26.0	41.3	12 PH-FLH	12FLHCFM	10GS12FLH45M
-12	20	3/4	1/2"	115.8	64.8	19.1	31.8	8 PH-FLH		12GS8FLH45
-12	20	3/4	3/4"	124.0	73.0	26.0	41.3	12 PH-FLH	12FLHCFM	12GS12FLH45M
-12	20	3/4	1"	130.0	79.0	32.0	47.6	16 PH-FLH	16FLHCFM	12GS16FLH45M
-16	25	1	3/4"	141.0	84.2	26.0	41.3	12 PH-FLH		16GS12FLH45M
-16	25	1	1"	147.0	90.6	32.0	47.6	16 PH-FLH	16FLHCFM	16GS16FLH45M
-16	25	1	1.1/4"	158.0	101.2	38.0	54.0	20 PH-FLH	20FLHCFM	16GS20FLH45M
-20	32	1.1/4	1"	191.1	120.0	33.7	47.6	16 PH-FLH		20GS16FLH45
-20	32	1.1/4	1.1/4"	176.0	104.9	38.1	54.0	20 PH-FLH	20FLHCFM	20GS20FLH45M
-20	32	1.1/4	1.1/2"	176.0	104.9	44.0	63.5	24 PH-FLH	20FLHCFM	20GS24FLH45M

M: Medium drop per ISO 12151-3. / Details on flange kits see page 250.

SAE FLH60

SAE 'O' ring flange high-pressure.
Code 62. 60° swept elbow.

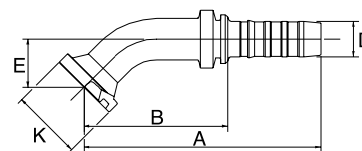

D				A	B	E	K	KIT	KIT	REF.
-size	DN	"		mm	mm	mm	mm			GS
-12	20	3/4	3/4"	137.0	86.0	37.0	41.3	12 PH-FLH	12FLHCFM	12GS12FLH60M
-12	20	3/4	1"	136.0	85.0	44.0	47.6	16 PH-FLH	16FLHCFM	12GS16FLH60M
-16	25	1	1"	157.0	100.6	44.0	47.6	16 PH-FLH	16FLHCFM	16GS16FLH60M
-20	32	1.1/4	1.1/4"	186.0	114.9	55.0	54.0	20 PH-FLH		20GS20FLH60M

M: Medium drop per ISO 12151-3. / Details on flange kits see page 250.

Unless otherwise stated the coupling meets the pressure rating requirements of the respective international standard.

SAE FLH67

SAE 'O' ring flange high-pressure.
Code 62. 67° swept elbow.

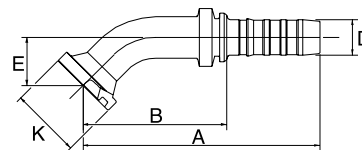

D				↔						
-size	DN	"		A	B	E	K	KIT	KIT	REF.
GS										
-16	25	1	1"	150.9	94.5	51.1	47.8	16 PH-FLH	16FLHCFM	16GS16FLH67M

M: Medium drop per ISO 12151-3. / Details on flange kits see page 250.

SAE FLH90S

SAE 'O' ring flange high-pressure.
Code 62. 90° swept elbow. Short drop.

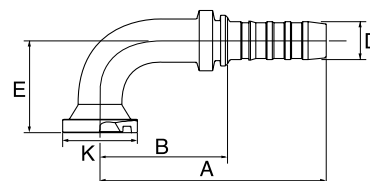

D				↔						
-size	DN	"		A	B	E	K	KIT	KIT	REF.
GS										
-12	20	3/4	1/2"	102.0	51.0	40.0	31.8	8 PH-FLH		12GS8FLH90-040
-16	25	1	1"	135.0	78.6	61.0	47.6	16 PH-FLH	16FLHCFM	16GS16FLH90S
-16	25	1	1.1/4"	134.0	76.8	68.0	54.0	20 PH-FLH	20FLHCFM	16GS20FLH90S
-16	25	1	1.1/2"	134.0	77.2	81.0	63.5	24 PH-FLH	24FLHCFM	16GS24FLH90S
-20	32	1.1/4	1"	160.0	88.9	61.0	47.6	16 PH-FLH		20GS16FLH90S
-20	32	1.1/4	1.1/2"	165.0	93.9	81.0	63.5	24 PH-FLH	24FLHCFM	20GS24FLH90S

S: Short drop per ISO 12151-3. / Details on flange kits see page 250.

Unless otherwise stated the coupling meets the pressure rating requirements of the respective international standard.

SAE FLH90M

SAE 'O' ring flange high-pressure. Code 62.
90° swept elbow. Medium drop.

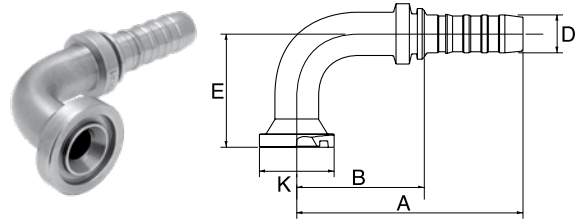

↔			⌋	↔						⌋
D				A	B	E	K	KIT	KIT	REF.
-size	DN	"		mm	mm	mm	mm			GS
-8	12	1/2	1/2"	88.0	50.5	40.0	31.8	8 PH-FLH	8FLHCFM	8GS8FLH90M
-8	12	1/2	3/4"	88.0	50.5	58.0	41.3	12 PH-FLH	12FLHCFM	8GS12FLH90M
-10	16	5/8	1/2"	113.0	62.7	40.0	31.8	8 PH-FLH		10GS8FLH90M
-10	16	5/8	3/4"	110.0	59.7	58.0	41.3	12 PH-FLH	12FLHCFM	10GS12FLH90M
-12	20	3/4	3/4"	112.0	61.0	58.0	41.3	12 PH-FLH	12FLHCFM	12GS12FLH90M
-12	20	3/4	1"	132.0	81.0	70.0	47.6	16 PH-FLH	16FLHCFM	12GS16FLH90M
-16	25	1	3/4"	135.0	78.6	58.0	41.3	12 PH-FLH		16GS12FLH90M
-16	25	1	1"	135.0	78.6	70.0	47.6	16 PH-FLH	16FLHCFM	16GS16FLH90M
-16	25	1	1.1/4"	134.0	76.8	90.0	54.0	20 PH-FLH	20FLHCFM	16GS20FLH90M
-20	32	1.1/4	1"	160.0	88.9	70.0	47.6	16 PH-FLH		20GS16FLH90M
-20	32	1.1/4	1.1/4"	165.0	93.9	90.0	54.0	20 PH-FLH	20FLHCFM	20GS20FLH90M

M: Medium drop per ISO 12151-3. / Details on flange kits see page 250.

SAE FLH90L

SAE 'O' ring flange high-pressure. Code 62.
90° swept elbow. Long drop.

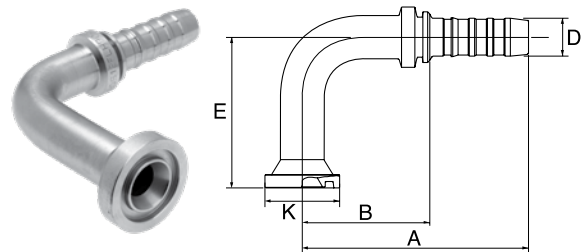

↔			⌋	↔						⌋
D				A	B	E	K	KIT	KIT	REF.
-size	DN	"		mm	mm	mm	mm			GS
-8	12	1/2	1/2"	88.0	50.5	100.0	31.8	8 PH-FLH	8FLHCFM	8GS8FLH90-100
-12	20	3/4	3/4"	112.0	61.0	100.0	41.3	12 PH-FLH	12FLHCFM	12GS12FLH90-100
-12	20	3/4	3/4"	116.0	65.7	150.0	41.3	12 PH-FLH	12FLHCFM	12GS12FLH90-150
-12	20	3/4	1"	116.0	65.0	100.0	47.7	16 PH-FLH	16FLHCFM	12GS16FLH90-100
-12	20	3/4	1"	119.0	68.0	120.0	47.6	16 PH-FLH	16FLHCFM	12GS16FLH90-120
-16	25	1	1"	135.0	78.2	100.0	47.6	16 PH-FLH	16FLHCFM	16GS16FLH90-100
-16	25	1	1"	134.0	77.6	120.0	47.6	16 PH-FLH	16FLHCFM	16GS16FLH90-120
-20	32	1.1/4	1"	160.0	88.9	100.0	47.6	16 PH-FLH		20GS16FLH90-100
-20	32	1.1/4	1.1/4"	165.0	93.9	120.0	54.0	20 PH-FLH		20GS20FLH90-120
-20	32	1.1/4	1.1/4"	169.0	97.9	150.0	54.0	20 PH-FLH	20FLHCFM	20GS20FLH90-150
-20	32	1.1/4	1.1/2"	169.0	97.9	150.0	63.5	24 PH-FLH	24FLHCFM	20GS24FLH90-150

Details on flange kits see page 250.

Unless otherwise stated the coupling meets the pressure rating requirements of the respective international standard.

SAE FLH130

SAE 'O' ring flange high-pressure.
Code 62. 130° swept elbow.

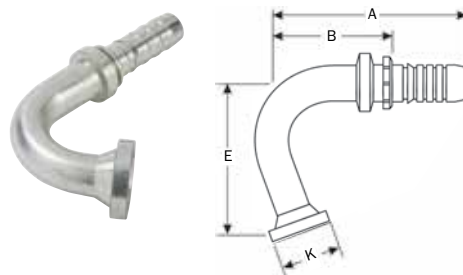

D				A	B	E	K	KIT	KIT	REF.
-size	DN	"		mm	mm	mm	mm			GS
-12	20	3/4	3/4"	103.0	52.0	71.4	41.3	12 PH-FLH	12FLHCFM	12GS12FLH130

Details on flange kits see page 250.

FLK

Komatsu type 'O' ring flange.

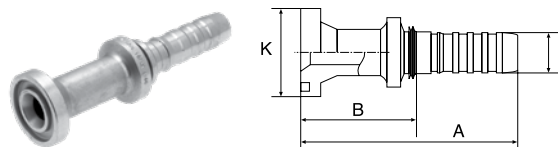

D				A	B	K	REF.
-size	DN	"		mm	mm	mm	GS
-8	12	1/2	5/8"	81.5	44.1	34.2	8GS10FLK
-10	16	5/8	5/8"	114.0	63.7	34.2	10GS10FLK
-12	20	3/4	5/8"	110.0	59.0	34.2	12GS10FLK

Unless otherwise stated the coupling meets the pressure rating requirements of the respective international standard.

TABLE OF CONTENTS

ABOUT GATES

HYDRAULIC HOSE

HYDRAULIC HOSE COUPLINGS

ENGINEERING AND TECHNICAL DATA

FLK45

Komatsu type 'O' ring flange.
45° swept elbow.

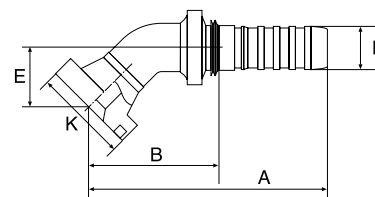

D				A	B	E	K	REF.
-size	DN	"		mm	mm	mm	mm	GS
-10	16	5/8	5/8"	121.0	70.7	26.0	34.2	10GS10FLK45-026

FLK90

Komatsu type 'O' ring flange.
90° swept elbow.

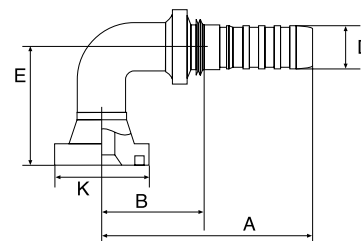

D				A	B	E	K	REF.
-size	DN	"		mm	mm	mm	mm	GS
-10	16	5/8	5/8"	110.0	59.7	55.0	34.2	10GS10FLK90-055
-12	20	3/4	5/8"	118.0	67.0	55.0	34.2	12GS10FLK90-055

Unless otherwise stated the coupling meets the pressure rating requirements of the respective international standard.

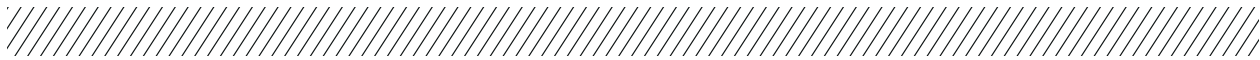

FLC

Caterpillar type 'O' ring flange.

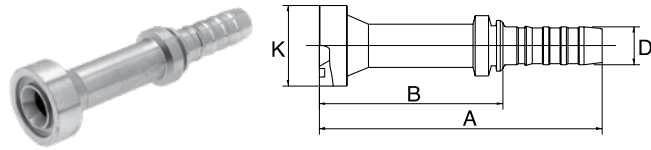

↔				↔			
D				A	B	K	REF.
-size	DN	"		mm	mm	mm	GS
-12	20	3/4	3/4"	145.0	94.0	41.3	12GS12FLC
-12	20	3/4	1"	145.0	94.0	47.6	12GS16FLC
-16	25	1	1"	155.0	98.2	47.6	16GS16FLC
-16	25	1	1.1/4"	155.0	98.2	54.0	16GS20FLC
-20	32	1.1/4	1.1/4"	187.0	115.9	54.0	20GS20FLC
-20	32	1.1/4	1.1/2"	187.0	115.9	63.5	20GS24FLC

-24 size is 42.0 MPa (6000 psi). / Note: FLC flanges are designed with a thicker flange head. The 14.2 mm flange dimension is frequently found on Caterpillar equipment. This flange lets the user utilise the Caterpillar flange clamp halves where practical when he replaces the hose assembly. At the user's option, standard Code 62 flanges and flange clamp halves can be used in place of the Caterpillar flanges and flange clamp halves. The standard Code 62 flange head thickness ranges between 7.8 and 12.7 mm.

FLC22

Caterpillar type 'O' ring flange.
22° swept elbow.

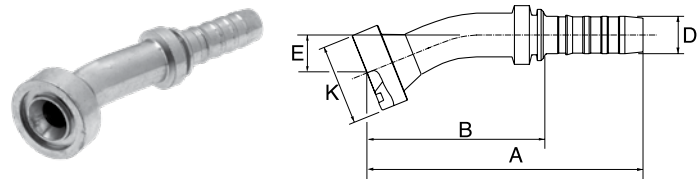

↔				↔				
D				A	B	E	K	REF.
-size	DN	"		mm	mm	mm	mm	GS
-12	20	3/4	3/4"	143.0	92.0	16.0	41.3	12GS12FLC22-016
-16	25	1	1"	153.0	95.9	17.0	47.6	16GS16FLC22-017
-16	25	1	1.1/4"	153.0	95.9	17.0	54.0	16GS20FLC22-017
-20	32	1.1/4	1.1/4"	185.0	113.9	17.0	54.0	20GS20FLC22-017
-20	32	1.1/4	1.1/2"	185.0	113.9	17.0	63.5	20GS24FLC22-017

-24 size is 42.0 MPa (6000 psi). / Note: FLC flanges are designed with a thicker flange head. The 14.2 mm flange dimension is frequently found on Caterpillar equipment. This flange lets the user utilise the Caterpillar flange clamp halves where practical when he replaces the hose assembly. At the user's option, standard Code 62 flanges and flange clamp halves can be used in place of the Caterpillar flanges and flange clamp halves. The standard Code 62 flange head thickness ranges between 7.8 and 12.7 mm.

Unless otherwise stated the coupling meets the pressure rating requirements of the respective international standard.

FLC30

Caterpillar type 'O' ring flange.
30° swept elbow.

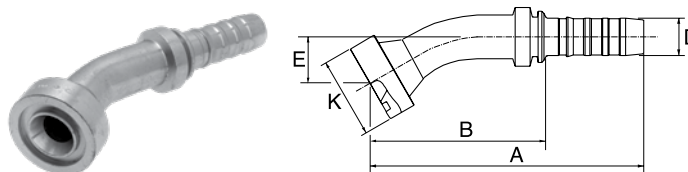

D				A B E K				
-size	DN	"		mm	mm	mm	mm	REF. GS
-12	20	3/4	3/4"	140.0	89.0	22.0	41.3	12GS12FLC30-022
-12	20	3/4	1"	141.0	90.0	22.0	47.6	12GS16FLC30-022
-16	25	1	1"	151.0	93.7	23.0	47.6	16GS16FLC30-023
-16	25	1	1.1/4"	151.0	93.7	23.0	54.0	16GS20FLC30-023
-20	32	1.1/4	1.1/4"	183.0	111.9	24.0	54.0	20GS20FLC30-024
-20	32	1.1/4	1.1/2"	183.0	111.9	24.0	63.5	20GS24FLC30-024

-24 size is 42.0 MPa (6000 psi). / Note: FLC flanges are designed with a thicker flange head. The 14.2 mm flange dimension is frequently found on Caterpillar equipment. This flange lets the user utilise the Caterpillar flange clamp halves where practical when he replaces the hose assembly. At the user's option, standard Code 62 flanges and flange clamp halves can be used in place of the Caterpillar flanges and flange clamp halves. The standard Code 62 flange head thickness ranges between 7.8 and 12.7 mm.

FLC45

Caterpillar type 'O' ring flange.
45° swept elbow.

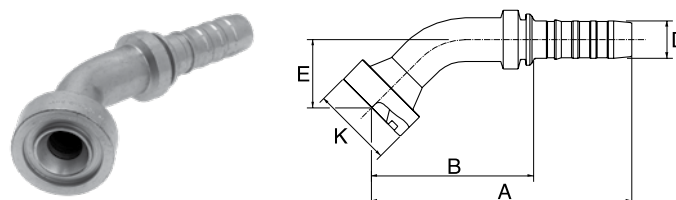

D				A B E K				
-size	DN	"		mm	mm	mm	mm	REF. GS
-12	20	3/4	3/4"	133.0	82.0	35.0	41.3	12GS12FLC45-035
-12	20	3/4	1"	133.0	82.0	35.0	47.6	12GS16FLC45-035
-16	25	1	1"	143.0	86.3	37.0	47.6	16GS16FLC45-037
-16	25	1	1.1/4"	143.0	86.3	37.0	54.0	16GS20FLC45-037
-20	32	1.1/4	1.1/4"	176.0	104.9	37.0	54.0	20GS20FLC45-037
-20	32	1.1/4	1.1/2"	176.0	104.9	37.0	63.5	20GS24FLC45-037

-24 size is 42.0 MPa (6000 psi). / Note: FLC flanges are designed with a thicker flange head. The 14.2 mm flange dimension is frequently found on Caterpillar equipment. This flange lets the user utilise the Caterpillar flange clamp halves where practical when he replaces the hose assembly. At the user's option, standard Code 62 flanges and flange clamp halves can be used in place of the Caterpillar flanges and flange clamp halves. The standard Code 62 flange head thickness ranges between 7.8 and 12.7 mm.

Unless otherwise stated the coupling meets the pressure rating requirements of the respective international standard.

FLC60

Caterpillar type 'O' ring flange.
60° swept elbow.

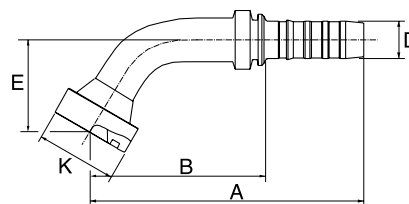

↔				↔				
D				A	B	E	K	REF.
-size	DN	"		mm	mm	mm	mm	GS
-12	20	3/4	1"	146.0	95.0	48.0	47.6	12GS16FLC60-048
-16	25	1	1"	163.0	106.0	50.0	47.6	16GS16FLC60-050
-16	25	1	1.1/4"	163.0	106.0	50.0	54.0	16GS20FLC60-050
-20	32	1.1/4	1.1/4"	198.0	126.9	52.0	54.0	20GS20FLC60-052
-20	32	1.1/4	1.1/2"	198.0	126.9	52.0	63.5	20GS24FLC60-052

-24 size is 42.0 MPa (6000 psi). / Note: FLC flanges are designed with a thicker flange head. The 14.2 mm flange dimension is frequently found on Caterpillar equipment. This flange lets the user utilise the Caterpillar flange clamp halves where practical when he replaces the hose assembly. At the user's option, standard Code 62 flanges and flange clamp halves can be used in place of the Caterpillar flanges and flange clamp halves. The standard Code 62 flange head thickness ranges between 7.8 and 12.7 mm.

FLC67

Caterpillar type 'O' ring flange.
67° swept elbow.

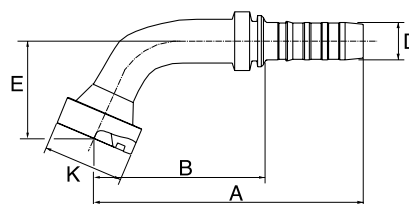

↔				↔				
D				A	B	E	K	REF.
-size	DN	"		mm	mm	mm	mm	GS
-16	25	1	1"	156.0	99.0	57.0	47.6	16GS16FLC67-057
-16	25	1	1.1/4"	156.0	99.0	57.0	54.0	16GS20FLC67-057
-20	32	1.1/4	1.1/4"	191.0	119.9	59.0	54.0	20GS20FLC67-059
-20	32	1.1/4	1.1/2"	191.0	119.9	59.0	63.5	20GS24FLC67-059

-24 size is 42.0 MPa (6000 psi). / Note: FLC flanges are designed with a thicker flange head. The 14.2 mm flange dimension is frequently found on Caterpillar equipment. This flange lets the user utilise the Caterpillar flange clamp halves where practical when he replaces the hose assembly. At the user's option, standard Code 62 flanges and flange clamp halves can be used in place of the Caterpillar flanges and flange clamp halves. The standard Code 62 flange head thickness ranges between 7.8 and 12.7 mm.

Unless otherwise stated the coupling meets the pressure rating requirements of the respective international standard.

TABLE OF CONTENTS

ABOUT GATES

HYDRAULIC HOSE

HYDRAULIC HOSE COUPLINGS

ENGINEERING AND TECHNICAL DATA

FLC90

Caterpillar type 'O' ring flange.
90° swept elbow.

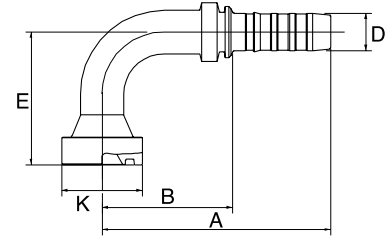

↻				↔				
D				A	B	E	K	REF.
-size	DN	"		mm	mm	mm	mm	GS
-12	20	3/4	3/4"	125.0	74.0	68.0	41.3	12GS12FLC90-068
-12	20	3/4	3/4"	117.0	66.0	128.0	41.3	12GS12FLC90-128
-12	20	3/4	1"	128.0	77.0	68.0	47.6	12GS16FLC90-068
-16	25	1	1"	131.0	74.1	74.0	47.6	16GS16FLC90-074
-16	25	1	1"	131.0	74.1	132.0	47.6	16GS16FLC90-132
-16	25	1	1.1/4"	131.0	74.1	74.0	54.0	16GS20FLC90-074
-20	32	1.1/4	1.1/4"	166.0	94.9	77.0	54.0	20GS20FLC90-077
-20	32	1.1/4	1.1/4"	241.0	170.3	150.0	54.0	20GS20FLC90-150
-20	32	1.1/4	1.1/2"	166.0	94.9	77.0	63.5	20GS24FLC90-077

-24 size is 42.0 MPa (6000 psi). / Note: FLC flanges are designed with a thicker flange head. The 14.2 mm flange dimension is frequently found on Caterpillar equipment. This flange lets the user utilise the Caterpillar flange clamp halves where practical when he replaces the hose assembly. At the user's option, standard Code 62 flanges and flange clamp halves can be used in place of the Caterpillar flanges and flange clamp halves. The standard Code 62 flange head thickness ranges between 7.8 and 12.7 mm.

DIN 24° FDLORX

Female DIN 'O' ring swivel. 24° cone.
Light series.

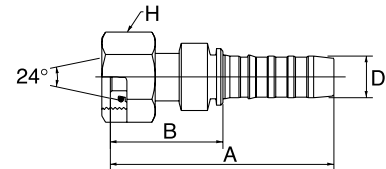

↻				↔			
D				A	B	H	REF.
-size	DN	"		mm	mm	mm	GS
-6	10	3/8	M18 x 1.5	73.0	37.2	22.0	6GS12FDLORX
-8	12	1/2	M22 x 1.5	73.0	35.5	27.0	8GS15FDLORX
-10	16	5/8	M26 x 1.5	91.8	41.5	32.0	10GS18FDLORX
-12	20	3/4	M30 x 2.0	97.0	46.0	36.0	12GS22FDLORX
-12	20	3/4	M36 x 2.0	99.0	48.0	41.0	12GS28FDLORX
-16	25	1	M36 x 2.0	105.0	48.6	41.0	16GS28FDLORX
-20	32	1.1/4	M45 x 2.0	132.5	61.4	50.0	20GS35FDLORX
-24	40	1.1/2	M52 x 2.0	135.7	62.0	60.0	24GSP42FDLORX

-6 to -20 size are 42.0 MPa (6000 psi).

Unless otherwise stated the coupling meets the pressure rating requirements of the respective international standard.

DIN 24° FDLORX45

Female DIN 'O' ring swivel. 24° cone.
Light series. 45° swept elbow.

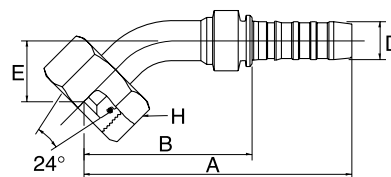

D			M	A				H	REF.
-size	DN	"		mm	mm	mm	mm		
-8	12	1/2	M22 x 1.5	94.7	57.2	20.2	27.0	8GS15FDLORX45	
-10	16	5/8	M26 x 1.5	121.9	71.6	24.8	32.0	10GS18FDLORX45	
-12	20	3/4	M30 x 2.0	135.8	84.8	29.8	36.0	12GS22FDLORX45	
-16	25	1	M36 x 2.0	155.5	99.1	30.9	41.0	16GS28FDLORX45	
-24	40	1.1/2	M52 x 2.0	208.9	135.2	44.0	60.0	24GSP42FDLORX45	

-8 to -16 size are 42.0 MPa (6000 psi).

DIN 24° FDLORX90

Female DIN 'O' ring swivel. 24° cone.
Light series. 90° swept elbow.

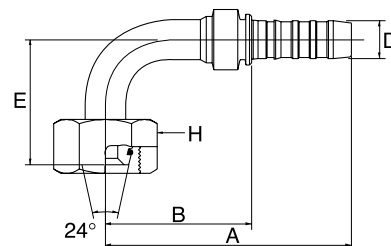

D			M	A				H	REF.
-size	DN	"		mm	mm	mm	mm		
-6	10	3/8	M18 x 1.5	78.0	42.2	37.0	22.0	6GS12FDLORX90	
-8	12	1/2	M22 x 1.5	88.0	50.5	42.0	27.0	8GS15FDLORX90	
-10	16	5/8	M26 x 1.5	113.5	63.2	51.5	32.0	10GS18FDLORX90	
-12	20	3/4	M30 x 2.0	126.0	75.0	62.0	36.0	12GS22FDLORX90	
-16	25	1	M36 x 2.0	151.0	94.6	70.0	41.0	16GS28FDLORX90	
-20	32	1.1/4	M45 x 2.0	180.5	109.4	80.0	50.0	20GS35FDLORX90	
-24	40	1.1/2	M52 x 2.0	194.6	120.9	92.0	60.0	24GSP42FDLORX90	

-6 to -16 size are 42.0 MPa (6000 psi).

Unless otherwise stated the coupling meets the pressure rating requirements of the respective international standard.

TABLE OF CONTENTS

ABOUT GATES

HYDRAULIC HOSE

HYDRAULIC HOSE COUPLINGS

ENGINEERING AND TECHNICAL DATA

DIN 24° MDL

Male DIN parallel. 24° inverted cone.
Light series.

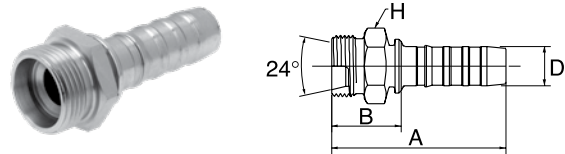

D				A	B	H	REF.
-size	DN	"		mm	mm	mm	GS
-6	10	3/8	M18 x 1.5	60.0	24.2	19.0	6GS12MDL
-8	12	1/2	M22 x 1.5	63.0	25.5	24.0	8GS15MDL
-10	16	5/8	M26 x 1.5	76.5	26.2	27.0	10GS18MDL
-12	20	3/4	M30 x 2.0	79.5	28.5	32.0	12GS22MDL
-16	25	1	M36 x 2.0	90.0	33.2	41.0	16GS28MDL
-24	40	1.1/2	M52 x 2.0	120.0	46.4	55.0	24GSP42MDL

-6 to -16 size are 42.0 MPa (6000 psi).

Unless otherwise stated the coupling meets the pressure rating requirements of the respective international standard.

DIN 24° FDHORX

Female DIN 'O' ring swivel. 24° cone.
Heavy series.

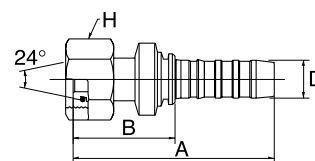

↔			🌀	↔			🌀
D				A	B	H	REF.
-size	DN	"		mm	mm	mm	GS
-6	10	3/8	M20 x 1.5	73.0	37.2	24.0	6GS12FDHORX
-6	10	3/8	M22 x 1.5	75.5	39.7	27.0	6GS14FDHORX
-8	12	1/2	M20 x 1.5	72.5	35.0	24.0	8GS12FDHORX
-8	12	1/2	M22 x 1.5	76.5	38.9	27.0	8GS14FDHORX
-8	12	1/2	M24 x 1.5	79.0	41.5	30.0	8GS16FDHORX
-8	12	1/2	M30 x 2.0	82.0	44.5	36.0	8GS20FDHORX
-10	16	5/8	M24 x 1.5	96.0	45.7	30.0	10GS16FDHORX
-10	16	5/8	M30 x 2.0	100.0	49.7	36.0	10GS20FDHORX
-10	16	5/8	M36 x 2.0	104.0	53.7	46.0	10GS25FDHORX
-12	20	3/4	M30 x 2.0	103.0	52.0	36.0	12GS20FDHORX
-12	20	3/4	M36 x 2.0	107.4	56.4	46.0	12GS25FDHORX
-12	20	3/4	M42 x 2.0	97.0	46.0	50.0	12GS30FDHORX
-16	25	1	M36 x 2.0	116.0	59.6	46.0	16GS25FDHORX
-16	25	1	M42 x 2.0	118.0	61.6	50.0	16GS30FDHORX
-16	25	1	M52 x 2.0	111.8	55.1	38.0	16GS38FDHORX
-20	32	1.1/4	M52 x 2.0	145.0	73.9	60.0	20GS38FDHORX
-24	40	1.1/2	M52 x 2.0	150.0	76.4	60.0	24GSP38FDHORX

-6 to -20 size are 42.0 MPa (6000 psi).

DIN 24° FDHORX-RB

Female DIN 'O' ring swivel. 24° cone.
Heavy series. Rockbreaker version.

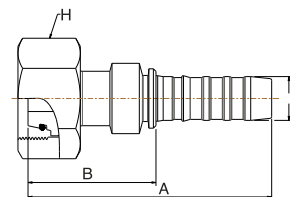

↔			🌀	↔			🌀
D				A	B	H	REF.
-size	DN	"		mm	mm	mm	GS
-10	16	5/8	M30 x 2.0	100.0	49.7	36.0	10GS20FDHORX-RB
-12	20	3/4	M36 x 2.0	107.4	56.4	46.0	12GS25FDHORX-RB
-16	25	1	M42 x 2.0	118.0	61.6	50.0	16GS30FDHORX-RB
-20	32	1.1/4	M52 x 2.0	145.0	73.9	60.0	20GS38FDHORX-RB

Unless otherwise stated the coupling meets the pressure rating requirements of the respective international standard.

DIN 24° FDHORX45

Female DIN 'O' ring swivel. 24° cone.
Heavy series. 45° swept elbow.

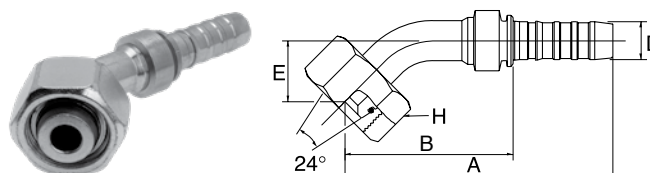

D				A	B	E	H	REF.
-size	DN	"		mm	mm	mm	mm	GS
-6	10	3/8	M20 x 1.5	86.7	50.8	18.9	24.0	6GS12FDHORX45
-6	10	3/8	M22 x 1.5	88.8	53.0	21.0	27.0	6GS14FDHORX45
-8	12	1/2	M24 x 1.5	96.1	58.7	21.6	30.0	8GS16FDHORX45
-10	16	5/8	M30 x 2.0	121.6	71.3	24.9	36.0	10GS20FDHORX45
-12	20	3/4	M30 x 2.0	160.9	109.9	29.8	36.0	12GS20FDHORX45
-12	20	3/4	M36 x 2.0	137.3	86.3	31.2	46.0	12GS25FDHORX45
-16	25	1	M36 x 2.0	159.7	103.3	35.1	46.0	16GS25FDHORX45
-16	25	1	M42 x 2.0	159.7	103.3	35.1	50.0	16GS30FDHORX45
-20	32	1.1/4	M52 x 2.0	196.0	124.9	42.5	60.0	20GS38FDHORX45
-24	40	1.1/2	M52 x 2.0	208.9	135.2	44.0	60.0	24GSP38FDHORX45

-6 to -20 size are 42.0 MPa (6000 psi).

DIN 24° FDHORX90

Female DIN 'O' ring swivel. 24° cone.
Heavy series. 90° swept elbow.

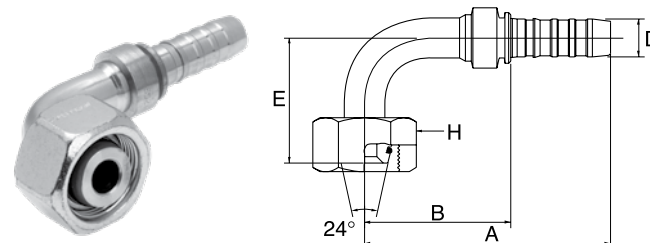

D				A	B	E	H	REF.
-size	DN	"		mm	mm	mm	mm	GS
-6	10	3/8	M20 x 1.5	78.0	42.2	37.0	24.0	6GS12FDHORX90
-6	10	3/8	M22 x 1.5	78.0	42.2	40.0	27.0	6GS14FDHORX90
-8	12	1/2	M24 x 1.5	88.0	50.5	44.0	30.0	8GS16FDHORX90
-10	16	5/8	M24 x 1.5	110.0	59.7	46.5	30.0	10GS16FDHORX90
-10	16	5/8	M30 x 2.0	112.5	62.2	51.0	36.0	10GS20FDHORX90
-12	20	3/4	M30 x 2.0	126.0	75.0	62.0	36.0	12GS20FDHORX90
-12	20	3/4	M36 x 2.0	126.0	75.0	64.0	46.0	12GS25FDHORX90
-16	25	1	M36 x 2.0	151.0	94.6	76.0	46.0	16GS25FDHORX90
-16	25	1	M42 x 2.0	151.0	94.6	76.0	50.0	16GS30FDHORX90
-20	32	1.1/4	M52 x 2.0	180.5	109.4	87.0	60.0	20GS38FDHORX90
-24	40	1.1/2	M52 x 2.0	194.6	121.0	92.0	60.0	24GSP38FDHORX90

-6 to -20 size are 42.0 MPa (6000 psi).

Unless otherwise stated the coupling meets the pressure rating requirements of the respective international standard.

DIN 24° MDH

Male DIN parallel. 24° inverted cone.
Heavy series.

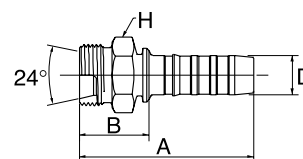

↔			🌀	↔			🌀
D				A	B	H	REF.
-size	DN	"		mm	mm	mm	GS
-6	10	3/8	M20 x 1.5	63.7	27.9	22.0	6GS12MDH
-6	10	3/8	M22 x 1.5	65.7	29.9	24.0	6GS14MDH
-8	12	1/2	M24 x 1.5	67.5	30.0	27.0	8GS16MDH
-10	16	5/8	M30 x 2.0	85.0	34.7	32.0	10GS20MDH
-12	20	3/4	M30 x 2.0	85.0	34.0	32.0	12GS20MDH
-12	20	3/4	M36 x 2.0	89.0	38.0	41.0	12GS25MDH
-12	20	3/4	M42 x 2.0	95.0	44.0	46.0	12GS30MDH
-16	25	1	M36 x 2.0	97.0	40.2	41.0	16GS25MDH
-16	25	1	M42 x 2.0	99.0	42.2	46.0	16GS30MDH
-20	32	1.1/4	M52 x 2.0	123.0	51.9	55.0	20GS38MDH

-6 to -20 size are 42.0 MPa (6000 psi).

NPTF MP

Male NPTF pipe.

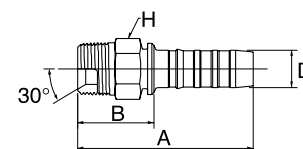

↔			🌀	↔			🌀
D				A	B	H	REF.
-size	DN	"		mm	mm	mm	GS
-6	10	3/8	3/8" - 18 NPTF	69.0	33.2	17.5	6GS6MP
-6	10	3/8	1/2" - 14 NPTF	73.0	37.2	22.2	6GS8MP
-8	12	1/2	1/2" - 14 NPTF	47.0	36.5	22.2	8GS8MP
-8	12	1/2	3/4" - 14 NPTF	77.0	39.5	27.0	8GS12MP
-10	16	5/8	1/2" - 14 NPTF	87.0	36.7	23.8	10GS8MP
-10	16	5/8	3/4" - 14 NPTF	91.0	40.7	28.6	10GS12MP
-12	20	3/4	3/4" - 14 NPTF	90.0	39.0	27.0	12GS12MP
-12	20	3/4	1" - 11.5 NPTF	97.0	46.0	34.9	12GS16MP
-16	25	1	3/4" - 14 NPTF	101.0	44.2	34.9	16GS12MP
-16	25	1	1" - 11.5 NPTF	106.0	49.2	34.9	16GS16MP
-16	25	1	1.1/4" - 11.5 NPTF	109.0	52.2	44.5	16GS20MP
-20	32	1.1/4	1.1/4" - 11.5 NPTF	127.0	55.9	44.5	20GS20MP

-6 to -20 size are 42.0 MPa (6000 psi); -24 size is 24.5 MPa (3500 psi); -32 size is 17.5 MPa (2500 psi). / Warning: Use only in NPTF connections. Do not use in oil field (API) connections. Blow apart of an oil field connection can result in serious injuries.

Unless otherwise stated the coupling meets the pressure rating requirements of the respective international standard.

TABLE OF CONTENTS

ABOUT GATES

HYDRAULIC HOSE

HYDRAULIC HOSE COUPLINGS

ENGINEERING AND TECHNICAL DATA

UNF MB

Male SAE 'O' ring boss. SAE J1926/2.
ISO 11926/2 heavy duty (S series).

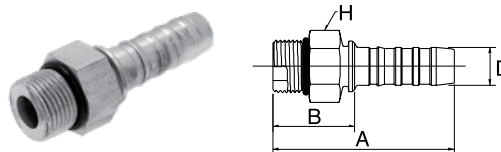

D				A	B	H	REF.
-size	DN	"		mm	mm	mm	GS
-6	10	3/8	9/16" - 18 UNF	65.0	29.2	17.5	6GS6MB
-8	12	1/2	3/4" - 16 UNF	70.0	32.6	22.2	8GS8MB
-8	12	1/2	7/8" - 14 UNF	72.0	34.5	25.4	8GS10MB
-10	16	5/8	7/8" - 14 UNF	88.0	37.7	25.4	10GS10MB
-10	16	5/8	1.1/16" - 12 UN	88.0	37.7	31.8	10GS12MB
-12	20	3/4	1.1/16" - 12 UN	93.0	42.0	31.8	12GS12MB
-12	20	3/4	1.5/16" - 12 UN	90.0	39.0	38.1	12GS16MB
-16	25	1	1.5/16" - 12 UN	98.0	41.2	38.1	16GS16MB
-20	32	1.1/4	1.5/8" - 12 UN	115.0	43.9	47.6	20GS20MB

-6 to -20 size are 42.0 MPa (6000 psi).

FG FFGX

Female French Gaz swivel. 24° cone.

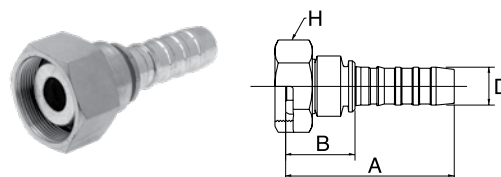

D				A	B	H	REF.
-size	DN	"		mm	mm	mm	GS
-8	12	1/2	M24 x 1.5	68.0	30.5	30.0	8GS17FFGX
-10	16	5/8	M30 x 1.5	82.5	32.2	36.0	10GS21FFGX
-12	20	3/4	M36 x 1.5	87.5	36.5	41.0	12GS27FFGX
-16	25	1	M45 x 1.5	95.5	39.1	55.0	16GS34FFGX

-8 to -16 size are 35.0 MPa (5000 psi).

Unless otherwise stated the coupling meets the pressure rating requirements of the respective international standard.

FG FFGX90

Female French Gaz swivel. 24° cone.
90° swept elbow.

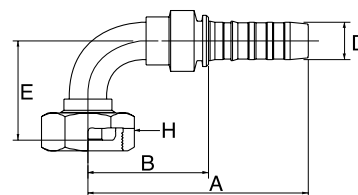

D			M24 x 1.5 M30 x 1.5	A B E H				REF. GS
-size	DN	"		mm	mm	mm	mm	
-8	12	1/2	M24 x 1.5	76.1	38.7	37.8	30.0	8GS17FFGX90
-10	16	5/8	M30 x 1.5	92.0	41.7	45.0	36.0	10GS21FFGX90

-8 to -10 size are 35.0 MPa (5000 psi).

FG MFG

Male French Gaz parallel. 24° inverted cone.

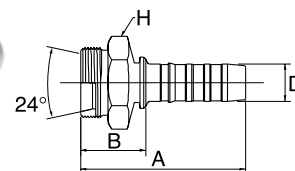

D			M24 x 1.5 M30 x 1.5 M36 x 1.5 M45 x 1.5	A B H			REF. GS
-size	DN	"		mm	mm	mm	
-8	12	1/2	M24 x 1.5	66.5	29.0	27.0	8GS17MFG
-10	16	5/8	M30 x 1.5	82.0	31.7	32.0	10GS21MFG
-12	20	3/4	M36 x 1.5	84.5	33.5	41.0	12GS27MFG
-16	25	1	M45 x 1.5	94.0	37.2	46.0	16GS34MFG

-8 to -16 size are 35.0 MPa (5000 psi).

Unless otherwise stated the coupling meets the pressure rating requirements of the respective international standard.

TABLE OF CONTENTS

ABOUT GATES

HYDRAULIC HOSE

HYDRAULIC HOSE COUPLINGS

ENGINEERING AND TECHNICAL DATA

FG FPFL

Female French Gaz flange high-pressure.
24° Poclairn inverted cone.

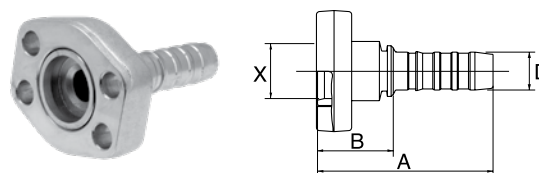

↔			↔			
D			X	A	B	REF.
-size	DN	"	mm	mm	mm	GS
-8	12	1/2	17.0	69.0	31.5	8GS17FPFL
-10	16	5/8	21.0	85.0	34.7	10GS21FPFL
-12	20	3/4	27.0	91.0	40.0	12GS27FPFL
-16	25	1	34.0	102.0	45.2	16GS34FPFL
-20	32	1.1/4	42.0	133.0	61.9	20GS42FPFL

-8 to -20 size are 35.0 MPa (5000 psi).

FG MPFL

Male French Gaz flange high-pressure.
24° Poclairn inverted cone.

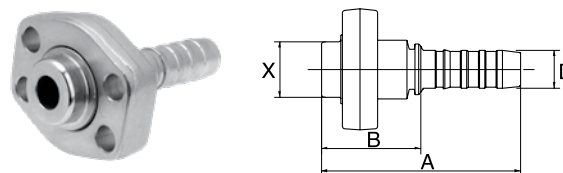

↔			↔			
D			X	A	B	REF.
-size	DN	"	mm	mm	mm	GS
-8	12	1/2	17.0	79.0	41.5	8GS17MPFL
-10	16	5/8	21.0	95.0	44.7	10GS21MPFL
-12	20	3/4	27.0	102.0	51.0	12GS27MPFL
-16	25	1	34.0	116.0	59.2	16GS34MPFL
-20	32	1.1/4	42.0	172.0	100.9	20GS42MPFL

-8 to -20 size are 35.0 MPa (5000 psi).

Unless otherwise stated the coupling meets the pressure rating requirements of the respective international standard.

FG MPFL90

Male French Gaz flange high-pressure.
24° Poclairn cone. 90° swept elbow.

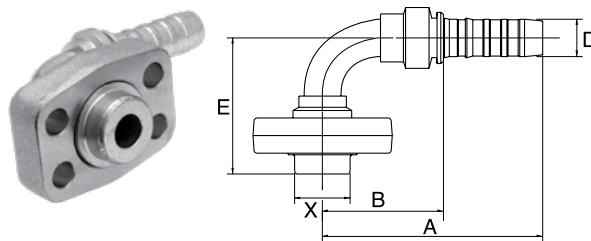

D			X	A	B	E	REF.
-size	DN	"	mm	mm	mm	mm	GS
-10	16	5/8	21.0	92.0	41.7	57.8	10GS21MPFL90
-12	20	3/4	27.0	100.0	49.3	68.8	12GS27MPFL90
-16	25	1	34.0	126.3	69.5	89.3	16GS34MPFL90
-20	32	1.1/4	42.0	149.9	78.7	89.4	20GS42MPFL90

-10 to -20 size are 35.0 MPa (5000 psi).

KOBELCO MKB

Male Kobelco type.

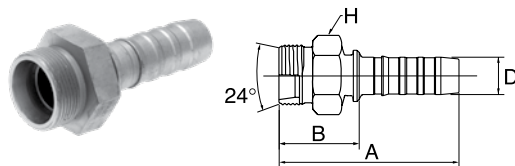

D				A	B	H	REF.
-size	DN	"		mm	mm	mm	GS
-12	20	3/4	M30 x 1.5	85.0	34.0	36.0	12GS22MKB
-12	20	3/4	M36 x 1.5	92.0	41.0	41.0	12GS28MKB
-16	25	1	M36 x 1.5	101.0	44.2	50.0	16GS28MKB
-16	25	1	M45 x 1.5	95.0	38.2	50.0	16GS35MKB

Unless otherwise stated the coupling meets the pressure rating requirements of the respective international standard.

TABLE OF CONTENTS

ABOUT GATES

HYDRAULIC HOSE

HYDRAULIC HOSE COUPLINGS

ENGINEERING AND TECHNICAL DATA

HLE

Hose length extender

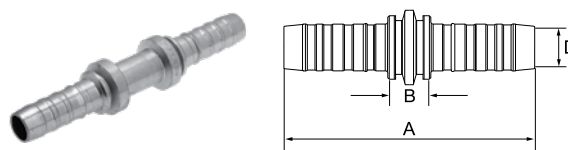

↔			↔		↔
D			A	B	REF.
-size	DN	"	mm	mm	GS
-8	12	1/2	94.0	19.1	8GS8HLE
-12	20	3/4	163.0	61.0	12GS12HLE
-16	25	1	180.0	66.4	16GS16HLE
-20	32	1.1/4	172.0	29.8	20GS20HLE

HLE 90

Hose length extender.
90° swept elbow.

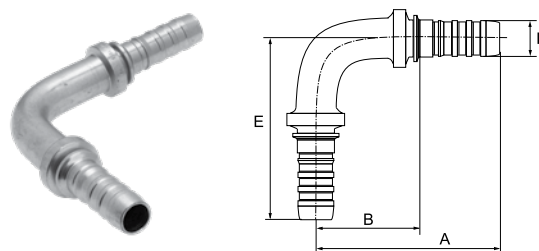

↔			↔			↔
D			A	B	E	REF.
-size	DN	"	mm	mm	mm	GS
-8	12	1/2	86.0	48.5	86.0	8GS8HLE90-086
-12	20	3/4	128.8	77.8	128.8	12GS12HLE90-129
-16	25	1	127.0	70.2	127.0	16GS16HLE90-127
-20	32	1.1/4	155.0	83.9	155.0	20GS20HLE90-155

Unless otherwise stated the coupling meets the pressure rating requirements of the respective international standard.



PL

Male Press-Lok.

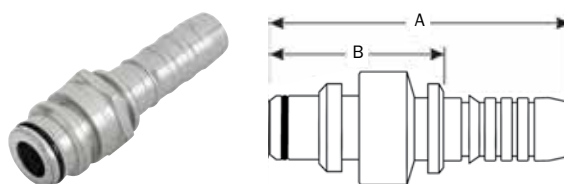

D			A	B	REF.
-size	DN	"	mm	mm	GS
-12	20	3/4	93.0	42.0	12GS12PL
-16	25	1	104.9	48.1	16GS16PL
-20	32	1.1/4	125.0	53.9	20GS20PL

PLSOR

Male Press-Lok Super 'O' ring.

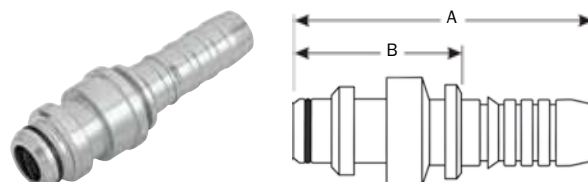

D			A	B	REF.
-size	DN	"	mm	mm	GS
-8	12	1/2	81.5	44.0	8GS8PLSOR
-12	20	3/4	100.5	50.0	12GS12PLSOR
-16	25	1	127.0	70.2	16GS16PLSOR
-20	32	1.1/4	150.5	79.4	20GS20PLSOR

Unless otherwise stated the coupling meets the pressure rating requirements of the respective international standard.

TABLE OF CONTENTS

ABOUT GATES

HYDRAULIC HOSE

HYDRAULIC HOSE COUPLINGS

ENGINEERING AND TECHNICAL DATA



**MEGASYS™ COUPLINGS FOR
WIRE AND TEXTILE BRAIDED
HYDRAULIC HOSES**



JIC 37° FJX

Female JIC swivel. 37° inverted cone.

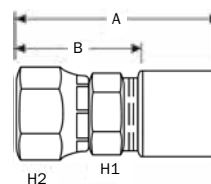

D			2.1/2" - 12 UN	A B H1 H2				REF. GL
-size	DN	"		mm	mm	mm	mm	
-40	63	2.1/2	2.1/2" - 12 UN	115.8	53.6	76.2	88.9	40GL40FJX

SAE FL

SAE 'O' ring flange. Code 61.

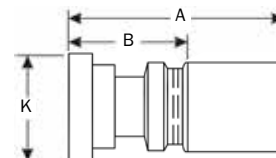

D			2.1/2" - 12 UN	A B K			REF. GL
-size	DN	"		mm	mm	mm	
-40	63	2.1/2	2.1/2"	143.8	80.0	84.1	40GL40FL
-40	63	2.1/2	3"	143.8	81.5	101.6	40GL48FL
-40	63	2.1/2	3.1/2"	135.4	70.4	114.3	40GL56FL
-40	63	2.1/2	4"	135.4	73.2	127.0	40GL64FL
-48	76	3	3"	166.1	87.9	101.6	48GL48FL
-56	89	3.1/2	3.1/2"	170.2	77.7	114.3	56GL56FL
-64	102	4	4"	196.6	94.0	127.0	64GL64FL

Unless otherwise stated the coupling meets the pressure rating requirements of the respective international standard.

TABLE OF CONTENTS

ABOUT GATES

HYDRAULIC HOSE

HYDRAULIC HOSE COUPLINGS

ENGINEERING AND TECHNICAL DATA

SAE FL22

SAE 'O' ring flange. Code 61.
22° swept elbow.

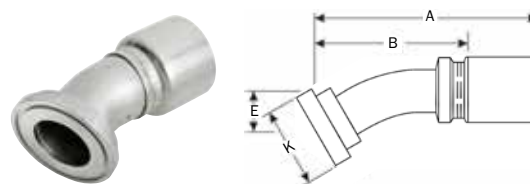

D				A	B	E	K	REF.
-size	DN	"		mm	mm	mm	mm	GL
-40	63	2.1/2	2.1/2"	173.0	110.7	16.0	84.1	40GL40FL22
-40	63	2.1/2	3"	174.2	112.0	17.0	101.6	40GL48FL22

SAE FL30

SAE 'O' ring flange. Code 61.
30° swept elbow.

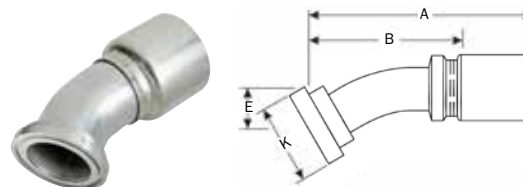

D				A	B	E	K	REF.
-size	DN	"		mm	mm	mm	mm	GL
-40	63	2.1/2	2.1/2"	185.4	123.2	27.4	84.1	40GL40FL30
-40	63	2.1/2	3"	186.9	124.7	27.4	101.6	40GL48FL30
-48	76	3	3"	209.0	130.8	28.5	101.6	48GL48FL30

Unless otherwise stated the coupling meets the pressure rating requirements of the respective international standard.

SAE FL45

SAE 'O' ring flange. Code 61.
45° swept elbow.

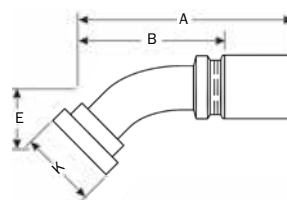

D				A B E K				REF.
-size	DN	"		mm	mm	mm	mm	GL
-40	63	2.1/2	2.1/2"	196.1	133.9	43.7	84.1	40GL40FL45
-40	63	2.1/2	3"	197.1	134.9	44.7	101.6	40GL48FL45
-48	76	3	3"	233.2	154.9	51.6	101.6	48GL48FL45
-48	76	3	3.1/2"	314.5	236.2	51.6	114.3	48GL56FL45
-56	89	3.1/2	3.1/2"	245.4	152.9	54.1	114.3	56GL56FL45
-56	89	3.1/2	4"	245.4	152.9	54.1	127.0	56GL64FL45
-64	102	4	4"	322.6	220.0	91.7	127.0	64GL64FL45

SAE FL60

SAE 'O' ring flange. Code 61.
60° swept elbow.

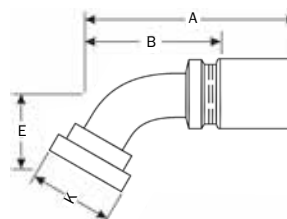

D				A B E K				REF.
-size	DN	"		mm	mm	mm	mm	GL
-40	63	2.1/2	2.1/2"	206.5	144.3	66.8	84.1	40GL40FL60
-48	76	3	3"	245.4	167.1	79.0	101.6	48GL48FL60

Unless otherwise stated the coupling meets the pressure rating requirements of the respective international standard.

TABLE OF CONTENTS

ABOUT GATES

HYDRAULIC HOSE

HYDRAULIC HOSE COUPLINGS

ENGINEERING AND TECHNICAL DATA

SAE FL67

SAE 'O' ring flange. Code 61.
67° swept elbow.

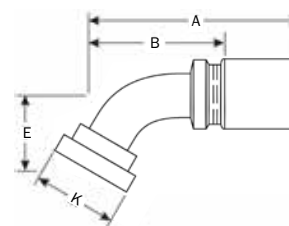

D				A	B	E	K	REF.
-size	DN	"		mm	mm	mm	mm	GL
-40	63	2.1/2	2.1/2"	208.8	146.6	79.5	84.1	40GL40FL67
-48	76	3	3"	241.3	163.1	98.3	101.6	48GL48FL67
-64	102	4	4"	360.7	258.3	175.3	127.0	64GL64FL67

SAE FL90

SAE 'O' ring flange. Code 61.
90° swept elbow.

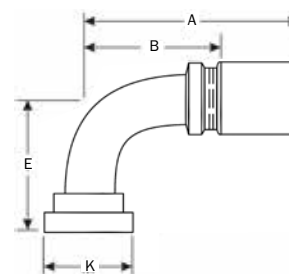

D				A	B	E	K	REF.
-size	DN	"		mm	mm	mm	mm	GL
-40	63	2.1/2	2.1/2"	204.7	142.5	117.4	84.1	40GL40FL90
-40	63	2.1/2	3"	206.3	144.0	117.4	101.6	40GL48FL90
-48	76	3	3"	246.4	168.2	139.7	101.6	48GL48FL90
-56	89	3.1/2	3.1/2"	258.3	165.9	143.0	114.3	56GL56FL90
-56	89	3.1/2	4"	256.3	163.8	175.3	127.0	56GL64FL90
-64	102	4	4"	320.3	217.9	187.5	127.0	64GL64FL90

Unless otherwise stated the coupling meets the pressure rating requirements of the respective international standard.

NO-SKIVE FERRULES

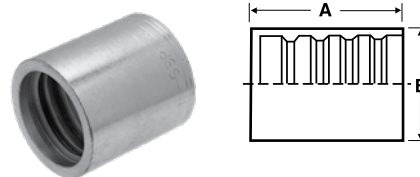

D			A	B		REF.
-size	DN	"	mm	mm		GSP
-24	40	1.1/2	75.8	70.0		24GSP1F-2
-32	50	2	90.0	83.5		32GSP1F-2

Note: Use GSP1F-2 only for wire braid hoses. For 6-spiral wire hose use 1-piece GSM coupling.

BSP FBSPORX

Female BSP 'O' ring swivel. 60° cone.

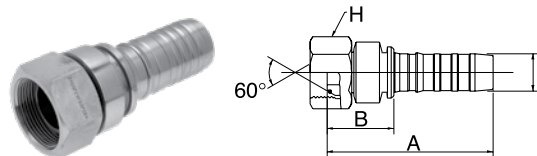

D			A	B	H	REF.	
-size	DN	"	mm	mm	mm	GSP	
-24	40	1.1/2	G 1.1/2" - 11 BSP	125.0	51.3	55.0	24GSP24FBSPORX
-32	50	2	G 2" - 11 BSP	153.0	61.0	70.0	32GSP32FBSPORX

BSP FBSPORX45

Female BSP 'O' ring swivel. 60° cone.
45° swept elbow.

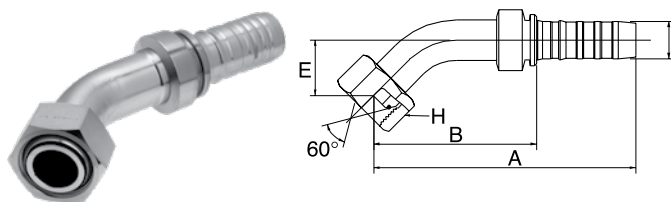

D			A	B	E	H	REF.	
-size	DN	"	mm	mm	mm	mm	GSP	
-24	40	1.1/2	G 1.1/2" - 11 BSP	214.5	140.9	49.7	55.0	24GSP24FBSPORX45
-32	50	2	G 2" - 11 BSP	276.1	184.1	62.3	70.0	32GSP32FBSPORX45

Unless otherwise stated the coupling meets the pressure rating requirements of the respective international standard.

TABLE OF CONTENTS

ABOUT GATES

HYDRAULIC HOSE

HYDRAULIC HOSE COUPLINGS

ENGINEERING AND TECHNICAL DATA

BSP FBSPORX90

Female BSP 'O' ring swivel. 60° cone. 90° swept elbow.

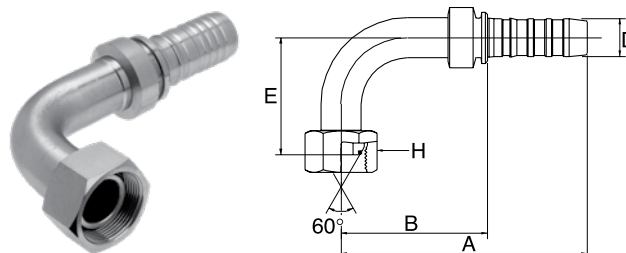

D				A B E H				REF.
-size	DN	"		mm	mm	mm	mm	GSP
-24	40	1.1/2	G 1.1/2" - 11 BSP	194.6	121.0	100.0	55.0	24GSP24FBSPORX90
-32	50	1	G 2" - 11 BSP	254.7	162.7	129.1	70.0	32GSP32FBSPORX90

BSP MBSP

Male BSP Parallel. 60° inverted cone.

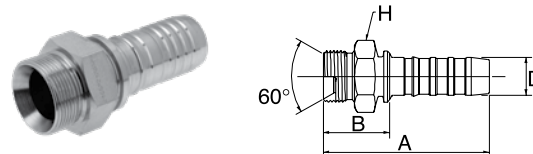

D				A B H			REF.
-size	DN	"		mm	mm	mm	GSP
-24	40	1.1/2	G 1.1/2" - 11 BSP	130.0	56.4	55.0	24GSP24MBSP
-32	50	2	G 2" - 11 BSP	148.8	56.8	70.0	32GSP32MBSP

JIC 37° FJX

Female JIC swivel. 37° inverted cone.

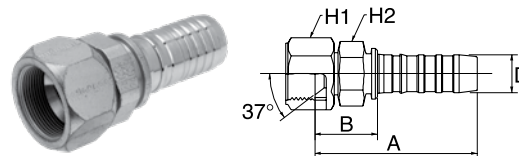

D				A B H1 H2				REF.
-size	DN	"		mm	mm	mm	mm	GSP
-24	40	1.1/2	1.7/8" - 12 UN	124.0	50.4	60.0	55.0	24GSP24FJX
-32	50	2	2.1/2" - 12 UN	148.0	56.0	75.0	65.0	32GSP32FJX

Unless otherwise stated the coupling meets the pressure rating requirements of the respective international standard.

JIC 37° FJX45

Female JIC swivel. 37° inverted cone.
45° swept elbow.

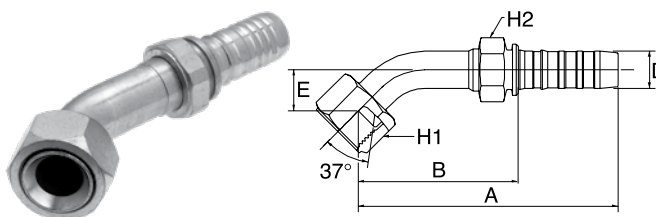

D			1.7/8" - 12 UN	A B E H1 H2					REF.
-size	DN	"		mm	mm	mm	mm	mm	
-24	40	1.1/2	1.7/8" - 12 UN	233.0	159.5	50.0	60.0	55.0	24GSP24FJX45-050
-32	50	2	2.1/2" - 12 UN	267.0	175.5	65.0	75.0	65.0	32GSP32FJX45-065

JIC 37° FJX90

Female JIC swivel. 37° inverted cone.
90° swept elbow.

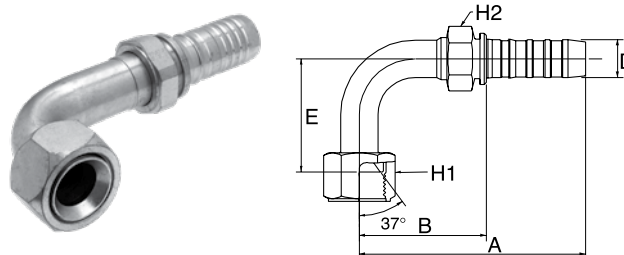

D			2.1/2" - 12 UN	A B E H1 H2					REF.
-size	DN	"		mm	mm	mm	mm	mm	
-24	40	1.1/2	1.7/8" - 12 UN	212.0	138.4	89.0	60.0	55.0	24GSP24FJX90-089
-32	50	2	2.1/2" - 12 UN	272.0	179.7	140.0	75.0	65.0	32GSP32FJX90M

M: Medium drop per ISO 12151-5.

JIC 37° MJ

Male JIC parallel. 37° cone.

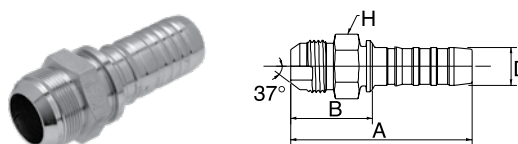

D			2.1/2" - 12 UN	A B H			REF.
-size	DN	"		mm	mm	mm	
-24	40	1.1/2	1.7/8" - 12 UN	130.0	56.4	50.0	24GSP24MJ
-32	50	2	2.1/2" - 12 UN	161.1	69.1	65.0	32GSP32MJ

Unless otherwise stated the coupling meets the pressure rating requirements of the respective international standard.

TABLE OF CONTENTS

ABOUT GATES

HYDRAULIC HOSE

HYDRAULIC HOSE COUPLINGS

ENGINEERING AND TECHNICAL DATA

SAE FFORX

Female SAE Flat Face 'O' ring swivel.

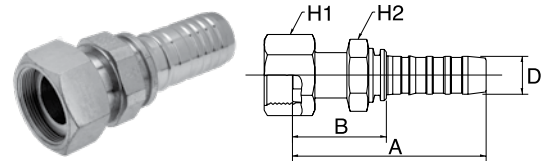

D				A B H1 H2				REF.
-size	DN	"		mm	mm	mm	mm	GSP
-24	40	1.1/2	2" - 12 UN	137.0	63.4	60.0	55.0	24GSP24FFORX

SAE FL

SAE 'O' ring flange. Code 61.

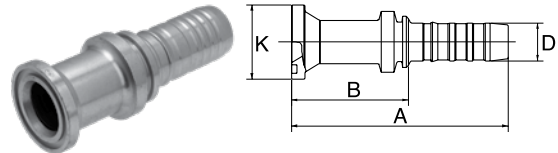

D				A B K			KIT	REF.
-size	DN	"		mm	mm	mm		GSP
-24	40	1.1/2	1.1/2"	152.9	79.3	60.3	24 PA-FL	24GSP24FL
-24	40	1.1/2	2"	152.9	79.3	71.4	32 PA-FL	24GSP32FL
-32	50	2	2"	159.3	67.3	71.4	32 PA-FL	32GSP32FL

Details on flange kits see page 250.

SAE FL22

SAE 'O' ring flange. Code 61.

22° swept elbow.

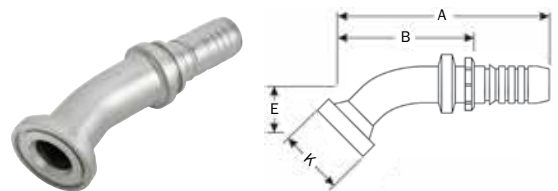

D				A B E K				KIT	REF.
-size	DN	"		mm	mm	mm	mm		GSP
-24	40	1.1/2	1.1/2"	211.0	137.5	18.0	60.3	24 PA-FL	24GSP24FL22M
-24	40	1.1/2	2"	214.0	140.2	22.0	71.4	24 PA-FL	24GSP32FL22M

Details on flange kits see page 250. / M: Short drop per ISO 12151-3.

Unless otherwise stated the coupling meets the pressure rating requirements of the respective international standard.

SAE FL30

SAE 'O' ring flange. Code 61.
30° swept elbow.

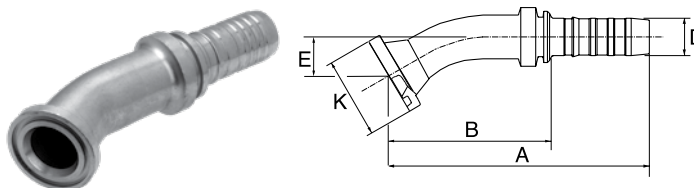

D				↔					
-size	DN	"		A	B	E	K	KIT	REF.
				mm	mm	mm	mm		GSP
-24	40	1.1/2	1.1/2"	209.0	135.2	25.0	60.3	24 PA-FL	24GSP24FL30S

Details on flange kits see page 250. / S: Short drop per ISO 12151-3.

SAE FL45

SAE 'O' ring flange. Code 61.
45° swept elbow.

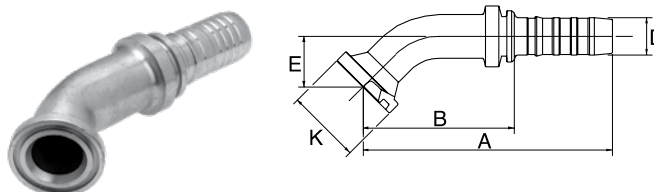

D				↔					
-size	DN	"		A	B	E	K	KIT	REF.
				mm	mm	mm	mm		GSP
-24	40	1.1/2	1.1/2"	202.0	128.6	38.0	60.3	24 PA-FL	24GSP24FL45S
-24	40	1.1/2	1.1/2"	200.0	126.3	52.0	71.4	32 PA-FL	24GSP32FL45S
-32	50	2	2"	257.0	165.0	66.0	71.4	32 PA-FL	32GSP32FL45-066

Details on flange kits see page 250. / S: Short drop per ISO 12151-3.

SAE FL60

SAE 'O' ring flange. Code 61.
60° swept elbow.

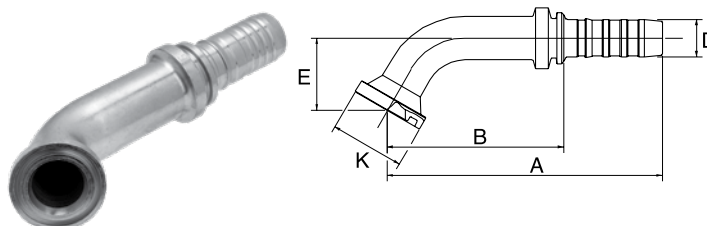

D				↔					
-size	DN	"		A	B	E	K	KIT	REF.
				mm	mm	mm	mm		GSP
-24	40	1.1/2	1.1/2"	231.0	157.5	53.0	60.3	24 PA-FL	24GSP24FL60S

Details on flange kits see page 250. / S: Short drop per ISO 12151-3.

Unless otherwise stated the coupling meets the pressure rating requirements of the respective international standard.

TABLE OF CONTENTS

ABOUT GATES

HYDRAULIC HOSE

HYDRAULIC HOSE COUPLINGS

ENGINEERING AND TECHNICAL DATA

SAE FL90

SAE 'O' ring flange. Code 61.
90° swept elbow.

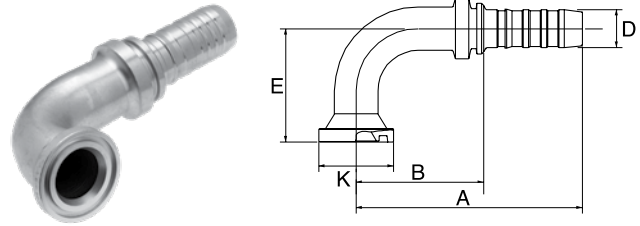

D			A	B	E	K	KIT	REF.
-size	DN	"						
-24	40	1.1/2	1.1/2"	184.0	109.9	81.0	60.3	24 PA-FL 24GSP24FL90S
-24	40	1.1/2	2"	175.0	101.9	80.0	71.4	32 PA-FL 24GSP32FL90-080
-32	50	2	1.1/2"	197.0	104.8	81.0	60.3	24 PA-FL 32GSP24FL90S
-32	50	2	2"	222.0	114.0	114.0	71.4	32 PA-FL 32GSP32FL90-114

Details on flange kits see page 250. / S: Short drop per ISO 12151-3.

DIN 24° FDLORX

Female DIN 'O' ring swivel. 24° cone.
Light series.

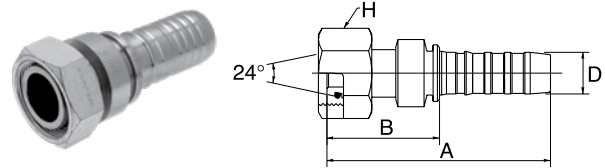

D			A	B	H	REF.	
-size	DN	"					mm
-24	40	1.1/2	M52 x 2.0	135.7	62.0	60.0	24GSP42FDLORX

DIN 24° FDLORX45

Female DIN 'O' ring swivel. 24° cone.
Light series. 45° swept elbow.

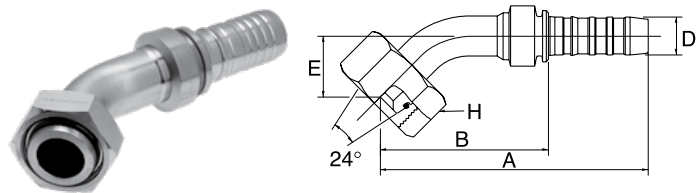

D			A	B	E	H	REF.	
-size	DN	"						mm
-24	40	1.1/2	M52 x 2.0	208.9	135.2	44.0	60.0	24GSP42FDLORX45

Unless otherwise stated the coupling meets the pressure rating requirements of the respective international standard.

DIN 24° FDLORX90

Female DIN 'O' ring swivel. 24° cone.
Light series. 90° swept elbow.

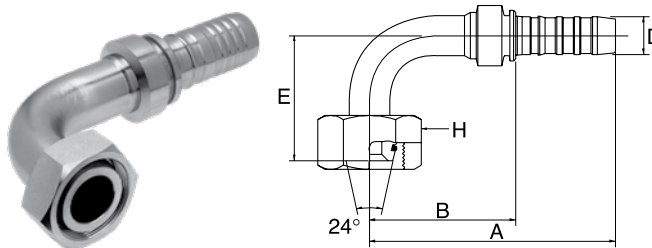

D			M52 x 2.0	A B E H				REF. GSP
-size	DN	"		mm	mm	mm	mm	
-24	40	1.1/2	M52 x 2.0	194.6	120.9	92.0	60.0	24GSP42FDLORX90

DIN 24° MDL

Male DIN parallel. 24° inverted cone.
Light series.

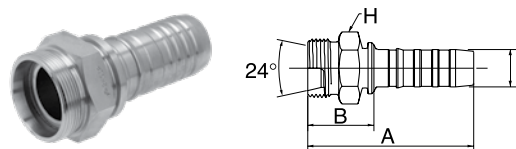

D			M52 x 2.0	A B H			REF. GSP
-size	DN	"		mm	mm	mm	
-24	40	1.1/2	M52 x 2.0	120.0	46.4	55.0	24GSP42MDL

DIN 24° FDHORX

Female DIN 'O' ring swivel. 24° cone.
Heavy series.

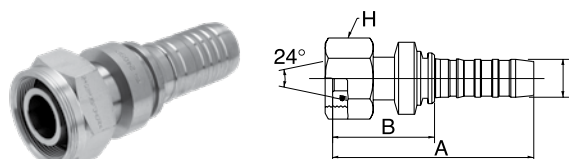

D			M52 x 2.0	A B H			REF. GSP
-size	DN	"		mm	mm	mm	
-24	40	1.1/2	M52 x 2.0	150.0	76.4	60.0	24GSP38FDHORX

Unless otherwise stated the coupling meets the pressure rating requirements of the respective international standard.

TABLE OF CONTENTS

ABOUT GATES

HYDRAULIC HOSE

HYDRAULIC HOSE COUPLINGS

ENGINEERING AND TECHNICAL DATA

DIN 24° FDHORX45

Female DIN 'O' ring swivel. 24° cone.
Heavy series. 45° swept elbow.

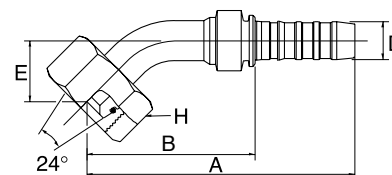

D			M52 x 2.0	A B E H				REF. GSP
-size	DN	"		mm	mm	mm	mm	
-24	40	1.1/2	M52 x 2.0	208.9	135.2	44.0	60.0	24GSP38FDHORX45

DIN 24° FDHORX90

Female DIN 'O' ring swivel. 24° cone.
Heavy series. 90° swept elbow.

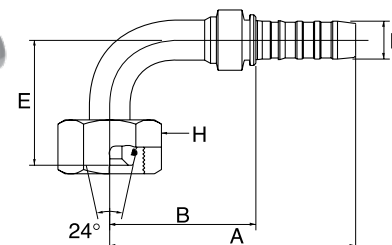

D			M52 x 2.0	A B E H				REF. GSP
-size	DN	"		mm	mm	mm	mm	
-24	40	1.1/2	M52 x 2.0	194.6	121.0	92.0	60.0	24GSP38FDHORX90

NPTF MP

Male NPTF pipe.

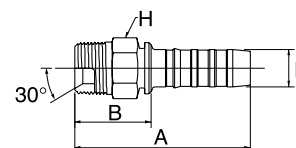

D			1.1/2" - 11.5 NPTF	A B H			REF. GSP
-size	DN	"		mm	mm	mm	
-24	40	1.1/2	1.1/2" - 11.5 NPTF	133.0	59.4	50.8	24GSP24MP
-32	50	2	2" - 11.5 NPTF	153.7	61.7	63.5	32GSP32MP

Warning: Use only in NPTF connections. Do not use in oil field (API) connections. Blow apart of an oil field connection can result in serious injuries.

Unless otherwise stated the coupling meets the pressure rating requirements of the respective international standard.



BSP MBSPT

Male BSP Taper.

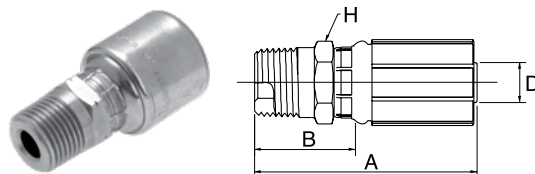

↻			🌀	↔			📏
D				A	B	H	REF.
-size	DN	"		mm	mm	mm	G
-4	6	1/4	R 1/4" - 19 BSP	51.5	28.4	14.0	4G4MBSPT
-4	6	1/4	R 3/8" - 19 BSP	52.9	29.8	19.0	4G6MBSPT
-5	8	5/16	R 3/8" - 19 BSP	54.1	26.1	19.0	5G6MBSPT
-6	10	3/8	R 3/8" - 19 BSP	58.2	30.3	19.0	6G6MBSPT
-6	10	3/8	R 1/2" - 19 BSP	62.7	34.7	22.0	6G8MBSPT
-8	12	1/2	R 3/8" - 19 BSP	65.5	28.0	22.0	8G6MBSPT
-8	12	1/2	R 1/2" - 14 BSP	69.4	31.9	22.0	8G8MBSPT
-10	16	5/8	R 5/8" - 14 BSP	70.0	32.5	24.0	10G10MBSPT
-12	20	3/4	R 3/4" - 14 BSP	89.0	38.0	32.0	12G12MBSPT
-16	25	1	R 1" - 11 BSP	98.4	41.6	36.0	16G16MBSPT

Unless otherwise stated the coupling meets the pressure rating requirements of the respective international standard.

TABLE OF CONTENTS

ABOUT GATES

HYDRAULIC HOSE

HYDRAULIC HOSE COUPLINGS

ENGINEERING AND TECHNICAL DATA

BSP FBSPORX

Female BSP 'O' ring swivel. 60° cone.

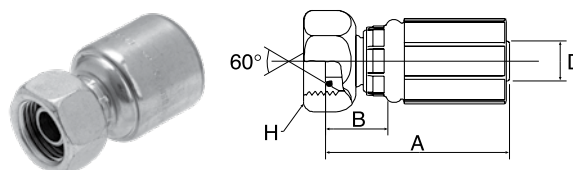

D				A	B	H	REF.
-size	DN	"		mm	mm	mm	G
-4	6	1/4	G 1/8" - 28 BSP	41.1	18.0	14.0	4G2FBSPPX ⁽¹⁾
-4	6	1/4	G 1/4" - 19 BSP	43.0	17.0	19.0	4G4FBSPORX
-4	6	1/4	G 3/8" - 19 BSP	44.0	18.0	22.0	4G6FBSPORX
-5	8	5/16	G 1/4" - 19 BSP	49.0	21.0	19.0	5G4FBSPORX
-5	8	5/16	G 3/8" - 19 BSP	46.0	18.0	22.0	5G6FBSPORX
-5	8	5/16	G 1/2" - 14 BSP	46.0	18.0	27.0	5G8FBSPORX
-6	10	3/8	G 1/4" - 19 BSP	49.0	21.1	29.0	6G4FBSPORX
-6	10	3/8	G 3/8" - 19 BSP	44.1	16.2	22.0	6G6FBSPORX
-6	10	3/8	G 1/2" - 14 BSP	45.8	17.9	27.0	6G8FBSPORX
-8	12	1/2	G 3/8" - 19 BSP	59.2	21.7	22.0	8G6FBSPORX
-8	12	1/2	G 1/2" - 14 BSP	55.3	17.8	27.0	8G8FBSPORX
-8	12	1/2	G 5/8" - 14 BSP	57.2	19.7	30.0	8G10FBSPORX
-8	12	1/2	G 3/4" - 14 BSP	59.0	21.5	32.0	8G12FBSPORX
-10	16	5/8	G 1/2" - 14 BSP	64.0	26.5	27.0	10G8FBSPORX
-10	16	5/8	G 5/8" - 14 BSP	56.0	18.5	30.0	10G10FBSPORX
-10	16	5/8	G 3/4" - 14 BSP	58.0	20.5	32.0	10G12FBSPORX
-12	20	3/4	G 3/4" - 14 BSP	71.6	20.6	32.0	12G12FBSPORX
-12	20	3/4	G 1" - 11 BSP	73.3	22.3	41.0	12G16FBSPORX
-16	25	1	G 3/4" - 14 BSP	82.7	25.9	32.0	16G12FBSPORX
-16	25	1	G 1" - 11 BSP	83.8	27.0	41.0	16G16FBSPORX
-20	32	1.1/4	G 1.1/4" - 11 BSP	88.5	29.5	50.0	20G20FBSPORX

(1) without 'O' ring.

Unless otherwise stated the coupling meets the pressure rating requirements of the respective international standard.

BSP FBSPORX45

Female BSP 'O' ring swivel. 60° cone.
45° swept elbow.

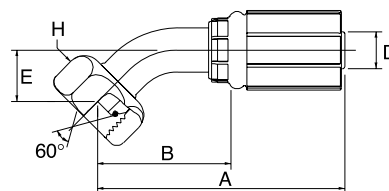

↻			🌀	↔				📏
D				A	B	E	H	REF.
-size	DN	"		mm	mm	mm	mm	G
-4	6	1/4	G 1/4" - 19 BSP	57.7	31.6	11.7	19.0	4G4FBSPORX45
-4	6	1/4	G 3/8" - 19 BSP	63.8	37.8	17.8	22.0	4G6FBSPORX45
-5	8	5/16	G 3/8" - 19 BSP	66.6	38.6	16.8	22.0	5G6FBSPORX45
-6	10	3/8	G 3/8" - 19 BSP	67.1	39.1	15.4	22.0	6G6FBSPORX45
-6	10	3/8	G 1/2" - 14 BSP	71.0	43.0	19.3	22.0	6G8FBSPORX45
-8	12	1/2	G 1/2" - 14 BSP	81.5	44.0	17.0	27.0	8G8FBSPORX45
-8	12	1/2	G 5/8" - 14 BSP	89.8	52.3	23.0	30.0	8G10FBSPORX45
-10	16	5/8	G 5/8" - 14 BSP	89.6	52.1	21.3	30.0	10G10FBSPORX45
-10	16	5/8	G 3/4" - 14 BSP	99.5	62.0	31.2	32.0	10G12FBSPORX45
-12	20	3/4	G 3/4" - 14 BSP	115.4	64.4	28.3	32.0	12G12FBSPORX45
-16	25	1	G 1" - 11 BSP	135.6	78.8	30.9	41.0	16G16FBSPORX45
-20	32	1.1/4	G 1.1/4" - 11 BSP	161.9	102.9	37.5	50.0	20G20FBSPORX45

Unless otherwise stated the coupling meets the pressure rating requirements of the respective international standard.

TABLE OF CONTENTS

ABOUT GATES

HYDRAULIC HOSE

HYDRAULIC HOSE COUPLINGS

ENGINEERING AND TECHNICAL DATA

BSP FBSPORX90

Female BSP 'O' ring swivel. 60° cone.
90° swept elbow.

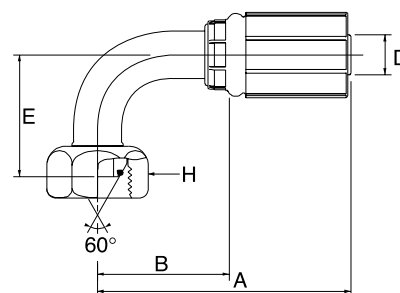

D				A	B	E	H	REF.
-size	DN	"		mm	mm	mm	mm	G
-4	6	1/4	G 1/4" - 19 BSP	53.0	27.0	23.5	19.0	4G4FBSPORX90
-4	6	1/4	G 3/8" - 19 BSP	53.0	27.0	32.0	22.0	4G6FBSPORX90
-5	8	5/16	G 3/8" - 19 BSP	58.0	30.0	32.0	22.0	5G6FBSPORX90
-6	10	3/8	G 1/4" - 19 BSP	59.9	31.9	36.0	19.0	6G4FBSPORX90
-6	10	3/8	G 3/8" - 19 BSP	61.9	34.0	32.0	22.0	6G6FBSPORX90
-6	10	3/8	G 1/2" - 14 BSP	60.1	32.2	37.5	22.0	6G8FBSPORX90
-8	12	1/2	G 3/8" - 19 BSP	69.9	32.4	36.1	22.0	8G6FBSPORX90
-8	12	1/2	G 1/2" - 14 BSP	78.0	40.5	37.5	27.0	8G8FBSPORX90
-8	12	1/2	G 5/8" - 14 BSP	80.2	42.8	46.0	30.0	8G10FBSPORX90
-10	16	5/8	G 5/8" - 14 BSP	84.1	46.6	46.0	30.0	10G10FBSPORX90
-10	16	5/8	G 3/4" - 14 BSP	84.1	46.6	60.0	32.0	10G12FBSPORX90
-12	20	3/4	G 3/4" - 14 BSP	107.0	56.0	60.0	32.0	12G12FBSPORX90
-12	20	3/4	G 1" - 11 BSP	112.2	61.2	70.0	41.0	12G16FBSPORX90
-16	25	1	G 3/4" - 14 BSP	108.8	52.0	54.1	32.0	16G12FBSPORX90
-16	25	1	G 1" - 11 BSP	131.1	74.3	70.0	41.0	16G16FBSPORX90
-20	32	1.1/4	G 1.1/4" - 11 BSP	151.4	92.4	80.0	50.0	20G20FBSPORX90

Unless otherwise stated the coupling meets the pressure rating requirements of the respective international standard.

BSP FBSPORX90BL

Female BSP 'O' ring swivel. 60° cone.
90° block elbow.

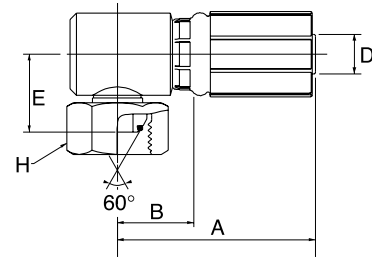

↻			🌀	↔				📏
D				A	B	E	H	REF.
-size	DN	"		mm	mm	mm	mm	G
-4	6	1/4	G 1/4" - 19 BSP	44.2	18.2	18.0	19.0	4G4FBSPORX90BL
-4	6	1/4	G 3/8" - 19 BSP	46.0	22.0	21.4	22.0	4G6FBSPORX90BL
-6	10	3/8	G 3/8" - 19 BSP	47.9	20.0	21.5	22.0	6G6FBSPORX90BL
-6	10	3/8	G 1/2" - 14 BSP	51.4	23.5	24.0	27.0	6G8FBSPORX90BL
-8	12	1/2	G 1/2" - 14 BSP	61.0	23.5	24.0	27.0	8G8FBSPORX90BL
-8	12	1/2	G 5/8" - 14 BSP	61.0	23.5	25.0	30.0	8G10FBSPORX90BL
-10	16	5/8	G 5/8" - 14 BSP	62.4	24.9	27.6	30.0	10G10FBSPORX90BL
-12	20	3/4	G 3/4" - 14 BSP	78.0	27.0	34.5	32.0	12G12FBSPORX90BL
-16	25	1	G 3/4" - 14 BSP	86.2	29.4	37.8	32.0	16G12FBSPORX90BL
-16	25	1	G 1" - 11 BSP	80.5	34.6	36.1	41.0	16G16FBSPORX90BL

BSP FBSPORX180

Female BSP 'O' ring swivel. 60° cone.
180° swept elbow.

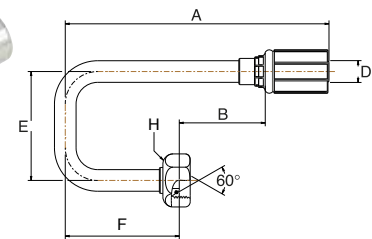

↻			🌀	↔					📏
D				A	B	E	F	H	REF.
-size	DN	"		mm	mm	mm	mm	mm	G
-4	6	1/4	G 1/4" - 19 BSP	82.2	56.1	38.0	33.2	19.0	4G4FBSPORX180
-6	10	3/8	G 3/8" - 19 BSP	107.0	79.1	60.0	50.0	22.0	6G6FBSPORX180
-8	12	1/2	G 1/2" - 14 BSP	155.0	117.5	64.0	67.0	27.0	8G8FBSPORX180
-10	16	5/8	G 5/8" - 14 BSP	84.0	46.5	64.0	35.0	30.0	10G10FBSPORX180
-12	20	3/4	G 3/4" - 14 BSP	92.2	41.2	106.0	93.4	32.0	12G12FBSPORX180

-4: MWP 42.0 MPa (6000 psi); -6: MWP 28.0 MPa (4000 psi); -8: MWP 24.5 MPa (3500 psi); -10: MWP 21.0 MPa (3000 psi); -12 MWP 28.0 MPa (4000 psi).

Unless otherwise stated the coupling meets the pressure rating requirements of the respective international standard.

BSP MBSP

Male BSP Parallel. 60° inverted cone.

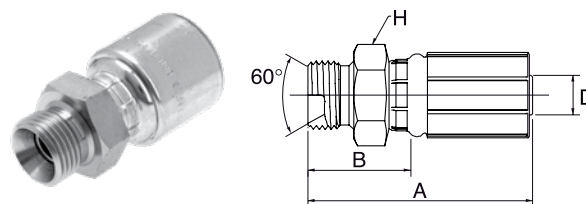

D				A	B	H1	REF.
-size	DN	"		mm	mm	mm	G
-4	6	1/4	G 1/4" - 19 BSP	51.9	25.9	19.0	4G4MBSPP
-4	6	1/4	G 3/8" - 19 BSP	53.8	27.8	22.0	4G6MBSPP
-4	6	1/4	G 1/2" - 14 BSP	55.9	29.9	27.0	4G8MBSPP
-5	8	5/16	G 1/4" - 19 BSP	49.4	25.5	19.0	5G4MBSPP
-5	8	5/16	G 3/8" - 19 BSP	49.7	25.8	22.0	5G6MBSPP
-6	10	3/8	G 1/4" - 19 BSP	54.0	26.1	19.0	6G4MBSPP
-6	10	3/8	G 3/8" - 19 BSP	56.0	28.1	22.0	6G6MBSPP
-6	10	3/8	G 1/2" - 14 BSP	58.0	30.1	27.0	6G8MBSPP
-8	12	1/2	G 3/8" - 19 BSP	65.5	28.0	22.0	8G6MBSPP
-8	12	1/2	G 1/2" - 14 BSP	71.5	34.0	27.0	8G8MBSPP
-8	12	1/2	G 5/8" - 14 BSP	68.5	31.0	30.0	8G10MBSPP
-8	12	1/2	G 3/4" - 14 BSP	72.5	35.0	32.0	8G12MBSPP
-10	16	5/8	G 5/8" - 14 BSP	72.0	34.5	30.0	10G10MBSPP
-10	16	5/8	G 3/4" - 14 BSP	74.0	36.5	32.0	10G12MBSPP
-12	20	3/4	G 3/4" - 14 BSP	90.0	39.0	32.0	12G12MBSPP
-16	25	1	G 1" - 11 BSP	101.0	44.2	41.0	16G16MBSPP
-20	32	1.1/4	G 1.1/4" - 11 BSP	110.0	51.0	50.0	20G20MBSPP

Unless otherwise stated the coupling meets the pressure rating requirements of the respective international standard.

BSP MBSPPBKHD

Male BSP parallel.
60° inverted cone (Bulkhead).

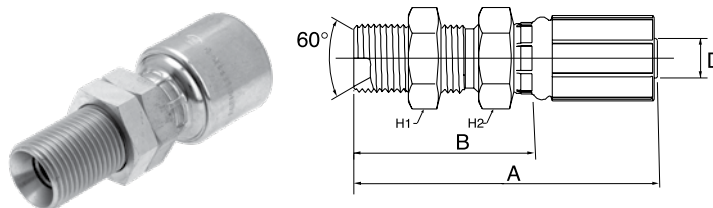

↻			🌀	↔				📏
D				A	B	H1	H2	REF.
-size	DN	"		mm	mm	mm	mm	G
-6	10	3/8	G 3/8" - 19 BSP	75.0	47.1	22.0	22.0	6G6MBSPPBKHD
-8	12	1/2	G 1/2" - 14 BSP	88.5	51.0	27.0	27.0	8G8MBSPPBKHD
-10	16	5/8	G 5/8" - 14 BSP	93.0	55.5	30.0	30.0	10G10MBSPPBKHD
-12	20	3/4	G 3/4" - 14 BSP	109.0	58.0	32.0	32.0	12G12MBSPPBKHD
-16	25	1	G 1" - 11 BSP	121.2	64.4	41.0	41.0	16G16MBSPPBKHD

BSP FBFFX

Female BSP flat face swivel.

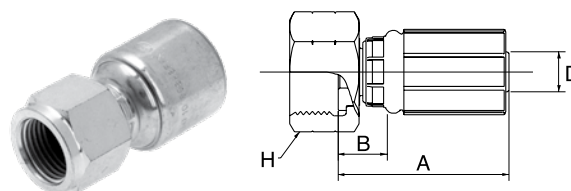

↻			🌀	↔			📏
D				A	B	H	REF.
-size	DN	"		mm	mm	mm	G
-5	8	5/16	G 1/2" - 14 BSP	45.5	17.5	27.0	5G8FBFFX
-6	10	3/8	G 3/8" - 19 BSP	44.5	16.6	22.0	6G6FBFFX
-6	10	3/8	G 1/2" - 14 BSP	44.0	16.1	27.0	6G8FBFFX
-8	12	1/2	G 1/2" - 14 BSP	53.5	16.0	27.0	8G8FBFFX
-8	12	1/2	G 5/8" - 14 BSP	54.0	16.5	30.0	8G10FBFFX
-8	12	1/2	G 3/4" - 14 BSP	51.5	14.0	32.0	8G12FBFFX
-10	16	5/8	G 3/4" - 14 BSP	52.0	14.5	32.0	10G12FBFFX
-12	20	3/4	G 3/4" - 14 BSP	65.5	14.5	32.0	12G12FBFFX

Unless otherwise stated the coupling meets the pressure rating requirements of the respective international standard.

TABLE OF CONTENTS

ABOUT GATES

HYDRAULIC HOSE

HYDRAULIC HOSE COUPLINGS

ENGINEERING AND TECHNICAL DATA

BSP MBFF

Male BSP flat face.

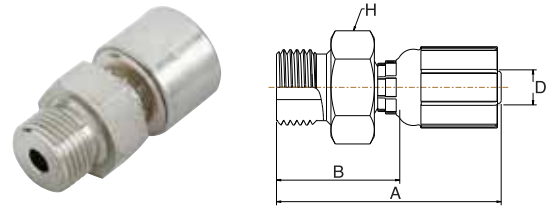

D				A	B	H	REF.
-size	DN	"		mm	mm	mm	G
-6	10	3/8	G 1/2" - 14 BSP	61.9	34.0	27.0	6G8MBFF

BSP BANJO

BSP banjo.

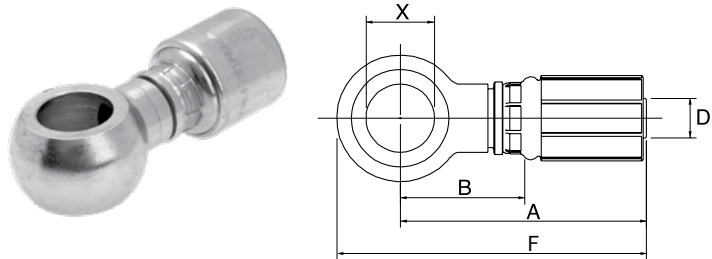

D				A	B	F	X	REF.
-size	DN	"		mm	mm	mm	mm	G
-4	6	1/4	1/8" - BSP	52.3	26.3	60.8	10.1	4G2BSPBJ
-4	6	1/4	1/4" - BSP	56.0	30.0	68.0	13.2	4G4BSPBJ
-4	6	1/4	3/8" - BSP	58.3	32.3	72.3	16.8	4G6BSPBJ
-5	8	5/16	1/4" - BSP	58.2	30.2	70.2	13.2	5G4BSPBJ
-5	8	5/16	3/8" - BSP	60.2	32.2	74.2	16.8	5G6BSPBJ
-6	10	3/8	1/4" - BSP	58.5	30.6	70.5	13.2	6G4BSPBJ
-6	10	3/8	3/8" - BSP	60.0	32.1	74.0	16.9	6G6BSPBJ
-6	10	3/8	1/2" - BSP	62.7	34.8	82.2	21.2	6G8BSPBJ
-8	12	1/2	3/8" - BSP	71.0	33.5	85.0	16.8	8G6BSPBJ
-8	12	1/2	1/2" - BSP	75.6	38.2	95.1	21.0	8G8BSPBJ
-8	12	1/2	5/8" - BSP	73.2	35.7	92.7	23.0	8G10BSPBJ
-8	12	1/2	3/4" - BSP	79.4	41.9	102.4	26.5	8G12BSPBJ
-10	16	5/8	5/8" - BSP	76.2	38.7	95.7	23.0	10G10BSPBJ
-10	16	5/8	3/4" - BSP	79.3	41.8	102.3	26.5	10G12BSPBJ
-12	20	3/4	3/4" - BSP	94.7	43.7	117.7	26.5	12G12BSPBJ
-12	20	3/4	1" - BSP	98.7	47.7	125.7	33.5	12G16BSPBJ
-16	25	1	1" - BSP	109.2	52.4	136.2	33.5	16G16BSPBJ

-4 to -16 size are 20.0 MPa (2900 psi), these maximum working pressure values are a guidance for the banjo body only, selection of sealing type and applied torque on banjo bolt can influence overall connection performance

Unless otherwise stated the coupling meets the pressure rating requirements of the respective international standard.

JIC 37° FJX

Female JIC swivel. 37° inverted cone.

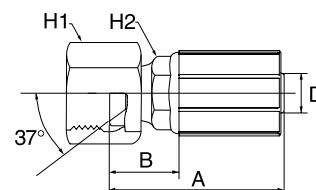

↻			🌀	↔				📏
D				A	B	H1	H2	REF.
-size	DN	"		mm	mm	mm	mm	G
-4	6	1/4	7/16" - 20 UNF	49.0	23.0	14.0	15.0	4G4FJX
-4	6	1/4	1/2" - 20 UNF	50.0	24.0	15.0	17.0	4G5FJX
-4	6	1/4	9/16" - 18 UNF	51.2	25.2	19.0	15.0	4G6FJX
-5	8	5/16	1/2" - 20 UNF	55.1	28.6	17.0	17.0	5G5FJX
-5	8	5/16	9/16" - 18 UNF	55.1	28.6	19.0	17.0	5G6FJX
-6	10	3/8	7/16" - 20 UNF	74.7	46.8	14.0	15.9	6G4FJX
-6	10	3/8	1/2" - 20 UNF	75.2	47.3	17.0	17.0	6G5FJX
-6	10	3/8	9/16" - 18 UNF	53.0	24.2	19.0	18.0	6G6FJX
-6	10	3/8	3/4" - 16 UNF	56.3	27.5	24.0	18.0	6G8FJX
-6	10	3/8	7/8" - 14 UNF	56.4	27.6	27.0	18.0	6G10FJX
-8	12	1/2	9/16" - 18 UNF	88.1	50.6	19.0	22.0	8G6FJX
-8	12	1/2	3/4" - 16 UNF	62.8	27.3	24.0	22.0	8G8FJX
-8	12	1/2	7/8" - 14 UNF	62.8	27.3	27.0	22.0	8G10FJX
-8	12	1/2	1.1/16" - 12 UN	62.8	27.3	32.0	22.0	8G12FJX
-10	16	5/8	3/4" - 16 UNF	92.6	55.1	24.0	24.0	10G8FJX
-10	16	5/8	7/8" - 14 UNF	66.0	28.5	27.0	24.0	10G10FJX
-10	16	5/8	1.1/16" - 12 UN	66.4	28.9	31.8	24.0	10G12FJX
-10	16	5/8	1.3/16" - 12 UN	70.0	32.5	36.0	24.0	10G14FJX
-12	20	3/4	7/8" - 14 UNF	122.0	71.0	27.0	27.0	12G10FJX
-12	20	3/4	1.1/16" - 12 UN	80.0	29.0	32.0	30.0	12G12FJX
-12	20	3/4	1.3/16" - 12 UN	80.8	29.8	36.0	30.0	12G14FJX
-12	20	3/4	1.5/16" - 12 UN	81.1	30.1	41.0	30.0	12G16FJX
-16	25	1	1.1/16" - 12 UN	135.9	79.2	32.0	36.0	16G12FJX
-16	25	1	1.3/16" - 12 UN	146.0	89.2	36.0	36.0	16G14FJX
-16	25	1	1.5/16" - 12 UN	91.0	34.2	41.0	36.0	16G16FJX
-16	25	1	1.5/8" - 12 UN	99.0	42.2	50.0	36.0	16G20FJX
-20	32	1.1/4	1.5/8" - 12 UN	96.0	37.0	50.0	41.0	20G20FJX
-20	32	1.1/4	1.7/8" - 12 UN	104.0	45.0	60.0	41.0	20G24FJX

Unless otherwise stated the coupling meets the pressure rating requirements of the respective international standard.

TABLE OF CONTENTS

ABOUT GATES

HYDRAULIC HOSE

HYDRAULIC HOSE COUPLINGS

ENGINEERING AND TECHNICAL DATA

JIC 37° FJX45

Female JIC swivel. 37° inverted cone.
45° swept elbow.

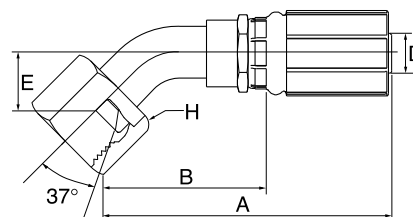

D				A	B	E	H	REF.
-size	DN	"		mm	mm	mm	mm	G
-4	6	1/4	7/16" - 20 UNF	69.7	43.7	10.0	14.0	4G4FJX45S
-4	6	1/4	1/2" - 20 UNF	65.8	39.7	11.0	17.0	4G5FJX45-011
-4	6	1/4	9/16" - 18 UNF	68.3	42.3	11.0	19.0	4G6FJX45S
-5	8	5/16	1/2" - 20 UNF	68.3	40.3	11.0	17.0	5G5FJX45-011
-5	8	5/16	9/16" - 18 UNF	72.4	44.4	11.0	19.0	5G6FJX45S
-6	10	3/8	7/16" - 20 UNF	72.7	44.8	10.0	14.0	6G4FJX45S
-6	10	3/8	9/16" - 18 UNF	77.5	49.6	11.0	19.0	6G6FJX45S
-6	10	3/8	3/4" - 16 UNF	89.1	61.2	15.0	24.0	6G8FJX45S
-8	12	1/2	3/4" - 16 UNF	86.9	49.5	15.0	24.0	8G8FJX45S
-8	12	1/2	7/8" - 14 UNF	96.8	59.4	16.0	27.0	8G10FJX45S
-10	16	5/8	7/8" - 14 UNF	96.4	59.0	16.0	27.0	10G10FJX45S
-10	16	5/8	1.1/16" - 12 UN	115.7	78.2	21.0	32.0	10G12FJX45S
-12	20	3/4	7/8" - 14 UNF	116.3	65.3	19.0	27.0	12G10FJX45S
-12	20	3/4	1.1/16" - 12 UN	128.2	77.2	21.0	32.0	12G12FJX45S
-12	20	3/4	1.5/16" - 12 UN	133.1	82.1	24.0	41.0	12G16FJX45S
-16	25	1	1.5/16" - 12 UN	144.3	87.5	24.0	41.0	16G16FJX45S
-20	32	1.1/4	1.5/8" - 12 UN	169.0	110.0	35.0	50.0	20G20FJX45-035

S: Short drop per ISO 12151-5.

Unless otherwise stated the coupling meets the pressure rating requirements of the respective international standard.

JIC 37° FJX90S

Female JIC swivel. 37° inverted cone.
90° swept elbow. Short drop.

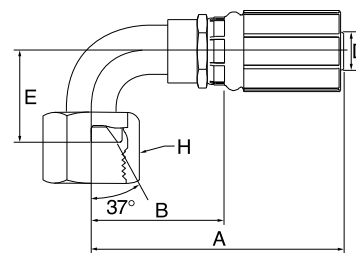

↻			🌀	↔				🔌
D				A	B	E	H	REF.
-size	DN	"		mm	mm	mm	mm	G
-4	6	1/4	7/16" - 20 UNF	63.1	37.1	21.0	14.0	4G4FJX90S
-4	6	1/4	1/2" - 20 UNF	62.2	36.2	23.0	17.0	4G5FJX90-023
-4	6	1/4	9/16" - 18 UNF	71.2	45.1	23.0	19.0	4G6FJX90S
-5	8	5/16	9/16" - 18 UNF	75.2	47.2	23.0	19.0	5G6FJX90S
-6	10	3/8	7/16" - 20 UNF	66.1	38.2	21.0	14.0	6G4FJX90S
-6	10	3/8	9/16" - 18 UNF	78.6	50.7	23.0	19.0	6G6FJX90S
-6	10	3/8	3/4" - 16 UNF	80.7	52.8	29.0	24.0	6G8FJX90S
-8	12	1/2	9/16" - 18 UNF	89.6	52.1	23.0	19.0	8G6FJX90S
-8	12	1/2	3/4" - 16 UNF	81.0	43.6	29.0	24.0	8G8FJX90S
-8	12	1/2	7/8" - 14 UNF	93.3	55.8	32.0	27.0	8G10FJX90S
-8	12	1/2	1.1/16" - 12 UN	108.7	71.2	48.0	32.0	8G12FJX90S
-10	16	5/8	7/8" - 14 UNF	89.0	51.5	36.0	27.0	10G10FJX90-036
-10	16	5/8	1.1/16" - 12 UN	107.3	69.8	48.0	32.0	10G12FJX90S
-12	20	3/4	1.1/16" - 12 UN	121.2	70.2	48.0	32.0	12G12FJX90S
-12	20	3/4	1.3/16" - 12 UN	124.0	73.0	54.0	36.0	12G14FJX90-054
-12	20	3/4	1.5/16" - 12 UN	132.7	81.7	56.0	41.0	12G16FJX90S
-16	25	1	1.5/16" - 12 UN	145.6	88.8	56.0	41.0	16G16FJX90S
-16	25	1	1.5/8" - 12 UN	157.0	100.2	64.0	50.0	16G20FJX90S

S: Short drop per ISO 12151-5.

Unless otherwise stated the coupling meets the pressure rating requirements of the respective international standard.

JIC 37° FJX90M

Female JIC swivel. 37° inverted cone.
90° swept elbow. Medium drop.

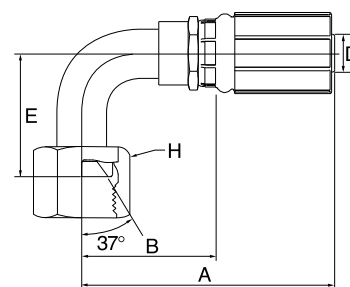

D				A	B	E	H	REF.
-size	DN	"		mm	mm	mm	mm	G
-4	6	1/4	7/16" - 20 UNF	63.1	37.1	32.0	14.0	4G4FJX90M
-4	6	1/4	1/2" - 20 UNF	57.2	31.2	32.0	17.0	4G5FJX90M
-4	6	1/4	9/16" - 18 UNF	64.9	38.9	38.0	19.0	4G6FJX90M
-5	8	5/16	1/2" - 20 UNF	64.6	36.6	32.0	17.0	5G5FJX90M
-5	8	5/16	9/16" - 18 UNF	76.0	48.0	38.0	19.0	5G6FJX90M
-6	10	3/8	9/16" - 18 UNF	76.5	48.5	38.0	19.0	6G6FJX90M
-6	10	3/8	3/4" - 16 UNF	84.1	56.2	41.0	24.0	6G8FJX90M
-6	10	3/8	7/8" - 14 UNF	82.5	54.6	47.0	27.0	6G10FJX90M
-8	12	1/2	3/4" - 16 UNF	77.3	39.9	41.0	24.0	8G8FJX90M
-8	12	1/2	7/8" - 14 UNF	93.3	55.8	47.0	27.0	8G10FJX90M
-10	16	5/8	7/8" - 14 UNF	93.4	55.9	47.0	27.0	10G10FJX90M
-10	16	5/8	1.1/16" - 12 UN	102.3	64.8	58.0	32.0	10G12FJX90M
-12	20	3/4	7/8" - 14 UNF	114.1	63.1	47.0	27.0	12G10FJX90M
-12	20	3/4	1.1/16" - 12 UN	120.2	69.2	58.0	32.0	12G12FJX90M
-16	25	1	1.5/16" - 12 UN	120.2	63.4	71.0	41.0	16G16FJX90M
-20	32	1.1/4	1.5/8" - 12 UN	159.0	100.0	78.0	50.0	20G20FJX90M

M: Medium drop per ISO 12151-5.

Unless otherwise stated the coupling meets the pressure rating requirements of the respective international standard.

JIC 37° FJX90L

Female JIC swivel. 37° inverted cone.
90° swept elbow. Long drop.

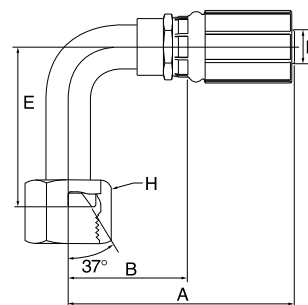

D				A B E H				REF.
-size	DN	"		mm	mm	mm	mm	
-4	6	1/4	7/16" - 20 UNF	63.1	37.1	46.0	14.0	4G4FJX90L
-4	6	1/4	1/2" - 20 UNF	57.2	31.2	46.0	17.0	4G5FJX90L
-4	6	1/4	9/16" - 18 UNF	69.3	43.2	54.0	19.0	4G6FJX90L
-6	10	3/8	7/16" - 20 UNF	60.2	32.3	46.0	14.0	6G4FJX90L
-6	10	3/8	9/16" - 18 UNF	70.6	42.7	54.0	19.0	6G6FJX90L
-6	10	3/8	3/4" - 16 UNF	84.5	56.6	64.0	24.0	6G8FJX90L
-8	12	1/2	3/4" - 16 UNF	77.3	39.9	64.0	24.0	8G8FJX90L
-8	12	1/2	7/8" - 14 UNF	93.3	55.8	70.0	27.0	8G10FJX90L
-10	16	5/8	7/8" - 14 UNF	85.9	48.4	70.0	27.0	10G10FJX90L
-10	16	5/8	1.1/16" - 12 UN	115.7	78.2	96.0	32.0	10G12FJX90L
-12	20	3/4	1.1/16" - 12 UN	122.2	71.2	96.0	32.0	12G12FJX90L
-12	20	3/4	1.3/16" - 12 UN	107.4	56.4	100.0	36.0	12G14FJX90-100
-16	25	1	1.5/16" - 12 UN	120.3	63.5	114.0	41.0	16G16FJX90L
-20	32	1.1/4	1.5/8" - 12 UN	158.0	99.0	129.0	50.0	20G20FJX90L

L: Long drop per ISO 12151-5.

Unless otherwise stated the coupling meets the pressure rating requirements of the respective international standard.

TABLE OF CONTENTS

ABOUT GATES

HYDRAULIC HOSE

HYDRAULIC HOSE COUPLINGS

ENGINEERING AND TECHNICAL DATA

JIC 37° MJ

Male JIC parallel. 37° cone.

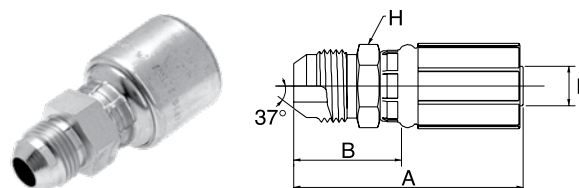

D				A	B	H	REF.
-size	DN	"		mm	mm	mm	G
-4	6	1/4	7/16" - 20 UNF	55.5	29.5	14.0	4G4MJ
-4	6	1/4	1/2" - 20 UNF	55.5	29.5	14.0	4G5MJ
-4	6	1/4	9/16" - 18 UNF	56.5	30.5	17.0	4G6MJ
-5	8	5/16	1/2" - 20 UNF	57.5	29.5	17.0	5G5MJ
-5	8	5/16	9/16" - 18 UNF	57.5	29.5	17.0	5G6MJ
-6	10	3/8	9/16" - 18 UNF	58.5	30.6	17.0	6G6MJ
-6	10	3/8	3/4" - 16 UNF	63.0	35.1	19.0	6G8MJ
-6	10	3/8	7/8" - 14 UNF	67.0	39.1	24.0	6G10MJ
-8	12	1/2	3/4" - 16 UNF	71.5	34.0	22.0	8G8MJ
-8	12	1/2	7/8" - 14 UNF	74.0	36.5	24.0	8G10MJ
-8	12	1/2	1.1/16" - 12 UN	81.0	43.5	27.0	8G12MJ
-10	16	5/8	3/4" - 16 UNF	74.5	37.0	24.0	10G8MJ
-10	16	5/8	7/8" - 14 UNF	77.0	39.5	24.0	10G10MJ
-10	16	5/8	1.1/16" - 12 UN	81.0	43.5	27.0	10G12MJ
-12	20	3/4	1.1/16" - 12 UN	94.5	43.5	27.0	12G12MJ
-12	20	3/4	1.3/16" - 12 UN	95.5	44.5	32.0	12G14MJ
-12	20	3/4	1.5/16" - 12 UN	96.0	45.0	36.0	12G16MJ
-16	25	1	1.5/16" - 12 UN	104.5	47.7	36.0	16G16MJ
-16	25	1	1.5/8" - 12 UN	109.0	52.2	44.5	16G20MJ
-20	32	1.1/4	1.5/8" - 12 UN	112.5	53.5	46.0	20G20MJ

Unless otherwise stated the coupling meets the pressure rating requirements of the respective international standard.

JIS FJISX

Female Japanese swivel.
30° inverted cone. BSP thread.

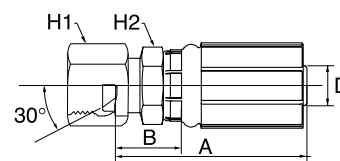

↻			🌀	↔				📏
D				A	B	H1	H2	REF.
-size	DN	"		mm	mm	mm	mm	G
-4	6	1/4	G 1/4" - 19 BSP	50.0	24.0	19.0	15.0	4G4FJISX
-6	10	3/8	G 3/8" - 19 BSP	52.0	24.1	22.0	17.0	6G6FJISX
-8	12	1/2	G 1/2" - 14 BSP	67.9	30.4	27.0	22.0	8G8FJISX
-12	20	3/4	G 3/4" - 14 BSP	81.3	30.3	36.0	30.0	12G12FJISX
-16	25	1	G 1" - 11 BSP	94.0	37.2	41.0	41.0	16G16FJISX
-20	32	1.1/4	G 1.1/4" - 11 BSP	124.1	65.1	50.0	50.0	20G20FJISX

JIS FKX

Female Japanese swivel.
30° inverted cone. Metric thread.

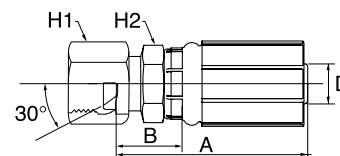

↻			🌀	↔				📏
D				A	B	H1	H2	REF.
-size	DN	"		mm	mm	mm	mm	G
-4	6	1/4	M14 x 1.5	46.5	20.5	19.0	14.0	4G4FKX
-6	10	3/8	M18 x 1.5	52.0	24.1	22.2	17.5	6G6FKX
-8	12	1/2	M22 x 1.5	61.5	24.0	27.0	22.0	8G8FKX
-10	16	5/8	M24 x 1.5	63.5	26.0	32.0	24.0	10G10FKX
-12	20	3/4	M30 x 1.5	82.3	31.3	36.0	30.0	12G12FKX
-16	25	1	M33 x 1.5	92.5	35.7	41.0	41.0	16G16FKX
-20	32	1.1/4	M36 x 1.5	105.0	46.0	50.8	44.5	20G20FKX

Unless otherwise stated the coupling meets the pressure rating requirements of the respective international standard.

TABLE OF CONTENTS

ABOUT GATES

HYDRAULIC HOSE

HYDRAULIC HOSE COUPLINGS

ENGINEERING AND TECHNICAL DATA

SAE FFORX

Female SAE flat face 'O' ring swivel.

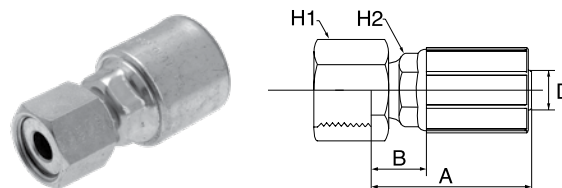

D				A	B	H1	H2	REF.
-size	DN	"		mm	mm	mm	mm	G
-4	6	1/4	9/16" - 18 UNF	52.5	26.5	17.0	15.0	4G4FFORX
-4	6	1/4	11/16" - 16 UN	51.1	25.1	22.0	15.0	4G6FFORX
-4	6	1/4	13/16" - 16 UN	50.5	24.5	24.0	15.0	4G8FFORX
-5	8	5/16	9/16" - 18 UNF	52.0	24.0	17.0	17.0	5G4FFORX
-5	8	5/16	11/16" - 16 UN	61.5	33.5	22.0	17.0	5G6FFORX
-6	10	3/8	9/16" - 18 UNF	78.3	50.3	17.0	17.0	6G4FFORX
-6	10	3/8	11/16" - 16 UN	57.7	28.9	22.0	18.0	6G6FFORX
-6	10	3/8	13/16" - 16 UN	57.4	28.6	24.0	18.0	6G8FFORX
-6	10	3/8	1" - 14 UNS	56.0	27.2	30.0	18.0	6G10FFORX
-8	12	1/2	11/16" - 16 UN	95.9	58.4	22.0	22.0	8G6FFORX
-8	12	1/2	13/16" - 16 UN	66.5	31.0	24.0	22.0	8G8FFORX
-8	12	1/2	1" - 14 UNS	70.0	34.8	30.0	22.0	8G10FFORX
-8	12	1/2	1.3/16" - 12 UN	71.5	36.3	36.0	22.0	8G12FFORX
-10	16	5/8	13/16" - 16 UN	97.2	59.7	24.0	24.0	10G8FFORX
-10	16	5/8	1" - 14 UNS	76.0	38.5	30.0	24.0	10G10FFORX
-10	16	5/8	1.3/16" - 12 UN	77.0	39.5	36.0	24.0	10G12FFORX
-12	20	3/4	1" - 14 UNS	95.1	44.1	30.0	30.0	12G10FFORX
-12	20	3/4	1.3/16" - 12 UN	92.8	41.8	36.0	30.0	12G12FFORX
-12	20	3/4	1.7/16" - 12 UN	88.3	37.3	41.0	30.0	12G16FFORX
-16	25	1	1.3/16" - 12 UN	141.8	85.0	36.0	36.0	16G12FFORX
-16	25	1	1.7/16" - 12 UN	104.0	47.2	41.0	36.0	16G16FFORX
-16	25	1	1.11/16" - 12 UN	103.0	46.2	50.0	36.0	16G20FFORX
-20	32	1.1/4	1.11/16" - 12 UN	109.0	50.0	50.0	41.0	20G20FFORX

Unless otherwise stated the coupling meets the pressure rating requirements of the respective international standard.

SAE FFORX45S

Female SAE flat face 'O' ring swivel.
45° swept elbow.

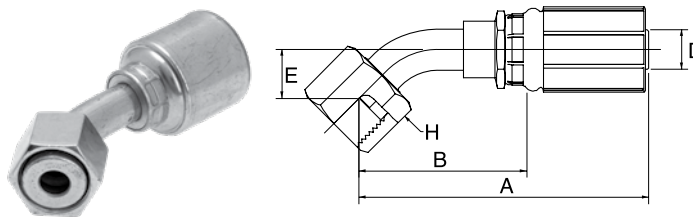

↻			🌀	↔				📏
D				A	B	E	H	REF.
-size	DN	"		mm	mm	mm	mm	G
-4	6	1/4	9/16" - 18 UNF	65.2	39.2	10.0	17.0	4G4FFORX45S
-4	6	1/4	11/16" - 16 UN	68.5	42.5	11.0	22.0	4G6FFORX45S
-5	8	5/16	11/16" - 16 UN	69.4	41.4	11.0	22.0	5G6FFORX45S
-6	10	3/8	9/16" - 18 UNF	66.1	38.1	10.0	17.0	6G4FFORX45S
-6	10	3/8	11/16" - 16 UN	69.8	41.9	11.0	22.0	6G6FFORX45S
-6	10	3/8	13/16" - 16 UN	85.2	57.3	15.0	24.0	6G8FFORX45S
-8	12	1/2	11/16" - 16 UN	90.7	53.2	11.0	22.0	8G6FFORX45S
-8	12	1/2	13/16" - 16 UN	89.0	51.6	15.0	24.0	8G8FFORX45S
-8	12	1/2	1" - 14 UNS	101.0	63.5	16.0	30.0	8G10FFORX45S
-8	12	1/2	1.3/16" - 12 UN	110.3	72.8	21.0	36.0	8G12FFORX45S
-10	16	5/8	13/16" - 16 UN	96.8	59.3	15.0	24.0	10G8FFORX45S
-10	16	5/8	1" - 14 UNS	100.5	63.0	16.0	30.0	10G10FFORX45S
-10	16	5/8	1.3/16" - 12 UN	105.9	68.4	21.0	36.0	10G12FFORX45S
-12	20	3/4	1" - 14 UNS	113.0	62.0	16.0	30.0	12G10FFORX45S
-12	20	3/4	1.3/16" - 12 UN	118.4	67.4	21.0	36.0	12G12FFORX45S
-12	20	3/4	1.7/16" - 12 UN	122.0	71.0	24.0	41.0	12G16FFORX45S
-16	25	1	1.3/16" - 12 UN	132.5	75.7	21.0	36.0	16G12FFORX45S
-16	25	1	1.7/16" - 12 UN	146.9	90.1	24.0	41.0	16G16FFORX45S
-20	32	1.1/4	1.11/16" - 12 UN	158.0	99.0	25.0	50.0	20G20FFORX45S

S: Short drop per ISO 12151-1.

Unless otherwise stated the coupling meets the pressure rating requirements of the respective international standard.

TABLE OF CONTENTS

ABOUT GATES

HYDRAULIC HOSE

HYDRAULIC HOSE COUPLINGS

ENGINEERING AND TECHNICAL DATA

SAE FFORX90S

Female SAE flat face 'O' ring swivel.
90° swept elbow. Short drop.

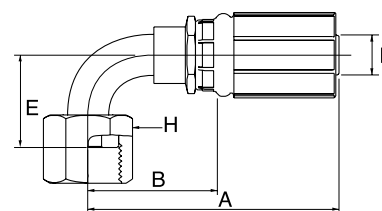

D				A	B	E	H	REF.
-size	DN	"		mm	mm	mm	mm	G
-4	6	1/4	9/16" - 18 UNF	60.2	34.2	21.0	17.0	4G4FFORX90S
-4	6	1/4	11/16" - 16 UN	63.4	37.4	23.0	22.0	4G6FFORX90S
-5	8	5/16	11/16" - 16 UN	72.0	44.0	23.0	22.0	5G6FFORX90S
-6	10	3/8	9/16" - 18 UNF	61.4	33.6	21.0	17.0	6G4FFORX90S
-6	10	3/8	11/16" - 16 UN	72.5	44.6	23.0	22.0	6G6FFORX90S
-6	10	3/8	13/16" - 16 UN	73.0	45.1	29.0	24.0	6G8FFORX90S
-8	12	1/2	11/16" - 16 UN	83.5	46.0	23.0	22.0	8G6FFORX90S
-8	12	1/2	13/16" - 16 UN	83.9	46.5	29.0	24.0	8G8FFORX90S
-8	12	1/2	1" - 14 UNS	92.9	55.4	32.0	30.0	8G10FFORX90S
-8	12	1/2	1.3/16" - 12 UN	102.9	65.4	48.0	36.0	8G12FFORX90S
-10	16	5/8	13/16" - 16 UN	92.4	54.9	29.0	24.0	10G8FFORX90S
-10	16	5/8	1" - 14 UNS	92.5	55.0	32.0	30.0	10G10FFORX90S
-10	16	5/8	1.3/16" - 12 UN	96.3	58.8	48.0	36.0	10G12FFORX90S
-12	20	3/4	1" - 14 UNS	104.0	53.0	32.0	30.0	12G10FFORX90S
-12	20	3/4	1.3/16" - 12 UN	108.8	57.8	48.0	36.0	12G12FFORX90S
-12	20	3/4	1.7/16" - 12 UN	128.5	77.5	56.0	41.0	12G16FFORX90S
-16	25	1	1.3/16" - 12 UN	129.4	72.6	48.0	36.0	16G12FFORX90S
-16	25	1	1.7/16" - 12 UN	129.9	73.1	56.0	41.0	16G16FFORX90S
-20	32	1.1/4	1.11/16" - 12 UN	150.0	91.0	64.0	50.0	20G20FFORX90S

S: Short drop per ISO 12151-1.

Unless otherwise stated the coupling meets the pressure rating requirements of the respective international standard.

SAE FFORX90M

Female SAE flat face 'O' ring swivel.
90° swept elbow. Medium drop.

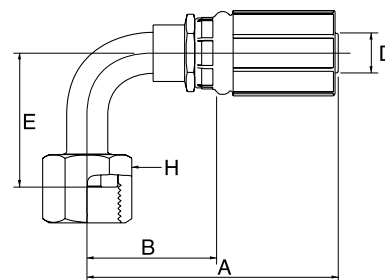

D				A	B	E	H	REF.
-size	DN	"		mm	mm	mm	mm	G
-4	6	1/4	9/16" - 18 UNF	56.2	30.2	32.0	17.0	4G4FFORX90M
-4	6	1/4	11/16" - 16 UN	63.4	37.4	38.0	22.0	4G6FFORX90M
-6	10	3/8	11/16" - 16 UN	63.6	35.7	38.0	22.0	6G6FFORX90M
-6	10	3/8	13/16" - 16 UN	68.5	40.6	41.0	24.0	6G8FFORX90M
-8	12	1/2	13/16" - 16 UN	83.9	46.5	41.0	24.0	8G8FFORX90M
-8	12	1/2	1" - 14 UNS	93.2	55.7	47.0	30.0	8G10FFORX90M
-10	16	5/8	1" - 14 UNS	92.8	55.3	47.0	30.0	10G10FFORX90M
-12	20	3/4	1.3/16" - 12 UN	109.0	58.0	58.0	36.0	12G12FFORX90M
-16	25	1	1.7/16" - 12 UN	129.9	73.1	71.0	41.0	16G16FFORX90M
-16	25	1	1.11/16" - 12 UN	156.0	99.2	78.0	50.0	16G20FFORX90M
-20	32	1.1/4	1.11/16" - 12 UN	140.0	81.0	78.0	50.0	20G20FFORX90M

M: Medium drop per ISO 12151-1.

Unless otherwise stated the coupling meets the pressure rating requirements of the respective international standard.

TABLE OF CONTENTS

ABOUT GATES

HYDRAULIC HOSE

HYDRAULIC HOSE COUPLINGS

ENGINEERING AND TECHNICAL DATA

SAE FFORX90L

Female SAE flat face 'O' ring swivel.
90° swept elbow. Long drop.

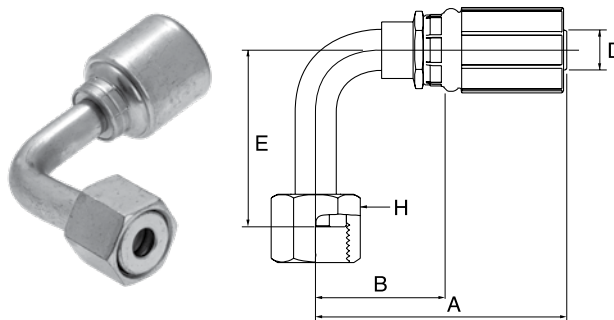

D				A	B	E	H	REF.
-size	DN	"		mm	mm	mm	mm	G
-4	6	1/4	9/16" - 18 UNF	56.2	30.2	46.0	17.0	4G4FFORX90L
-4	6	1/4	11/16" - 16 UN	61.6	35.6	54.0	22.0	4G6FFORX90L
-4	6	1/4	13/16" - 16 UN	67.1	41.1	64.0	24.0	4G8FFORX90L
-6	10	3/8	11/16" - 16 UN	69.3	41.4	54.0	22.0	6G6FFORX90L
-6	10	3/8	13/16" - 16 UN	69.0	41.1	64.0	24.0	6G8FFORX90L
-8	12	1/2	13/16" - 16 UN	83.9	46.5	64.0	24.0	8G8FFORX90L
-8	12	1/2	1" - 14 UNS	90.6	53.1	70.0	30.0	8G10FFORX90L
-10	16	5/8	13/16" - 16 UN	92.4	54.9	64.0	24.0	10G8FFORX90L
-10	16	5/8	1" - 14 UNS	90.2	52.7	70.0	30.0	10G10FFORX90L
-12	20	3/4	1.3/16" - 12 UN	118.2	67.2	96.0	36.0	12G12FFORX90L
-16	25	1	1.7/16" - 12 UN	129.9	73.1	114.0	41.0	16G16FFORX90L
-20	32	1.1/4	1.11/16" - 12 UN	140.0	81.0	129.0	50.0	20G20FFORX90L

L: Long drop per ISO 12151-1.

Unless otherwise stated the coupling meets the pressure rating requirements of the respective international standard.

SAE MFFOR

Male SAE flat face 'O' ring.

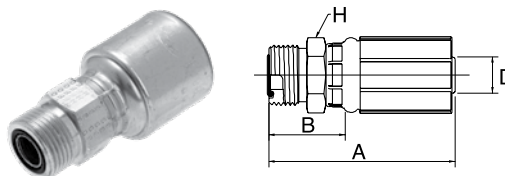

↻			🌀	↔			📏
D				A	B	H	REF.
-size	DN	"		mm	mm	mm	G
-4	6	1/4	9/16" - 18 UNF	52.5	26.5	17.0	4G4MFFOR
-4	6	1/4	11/16" - 16 UN	54.0	28.0	19.0	4G6MFFOR
-5	8	5/16	11/16" - 16 UN	56.0	28.0	19.0	5G6MFFOR
-6	10	3/8	11/16" - 16 UN	56.0	28.1	19.0	6G6MFFOR
-6	10	3/8	13/16" - 16 UN	59.0	31.1	22.0	6G8MFFOR
-6	10	3/8	1" - 14 UNS	64.0	36.1	27.0	6G10MFFOR
-8	12	1/2	13/16" - 16 UN	68.2	30.7	22.0	8G8MFFOR
-8	12	1/2	1" - 14 UNS	73.0	35.5	27.0	8G10MFFOR
-10	16	5/8	1" - 14 UNS	73.0	35.5	27.0	10G10MFFOR
-10	16	5/8	1.3/16" - 12 UN	77.0	39.5	32.0	10G12MFFOR
-12	20	3/4	1.3/16" - 12 UN	90.0	39.0	32.0	12G12MFFOR
-12	20	3/4	1.7/16" - 12 UN	95.0	44.0	41.0	12G16MFFOR
-16	25	1	1.7/16" - 12 UN	102.0	45.2	41.0	16G16MFFOR
-16	25	1	1.11/16" - 12 UN	105.0	48.2	46.0	16G20MFFOR
-20	32	1.1/4	1.11/16" - 12 UN	109.0	50.0	46.0	20G20MFFOR

SAE MFFORBKHD

Male SAE flat face 'O' ring.
Bulkhead.

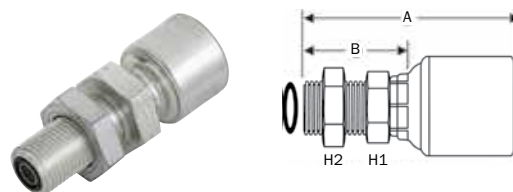

↻			🌀	↔				📏
D				A	B	H1	H2	REF.
-size	DN	"		mm	mm	mm	mm	G
-4	6	1/4	9/16" - 18 UNF	71.1	45.1	22.0	22.0	4G4MFFORBKHD ⁽¹⁾
-6	10	3/8	11/16" - 16 UN	78.1	50.2	27.0	27.0	6G6MFFORBKHDLN
-8	12	1/2	13/16" - 16 UN	90.2	52.7	30.0	30.0	8G8MFFORBKHDLN

(1) locknut not included

Unless otherwise stated the coupling meets the pressure rating requirements of the respective international standard.

SAE 45° FSX

Female SAE swivel. 45° inverted cone.

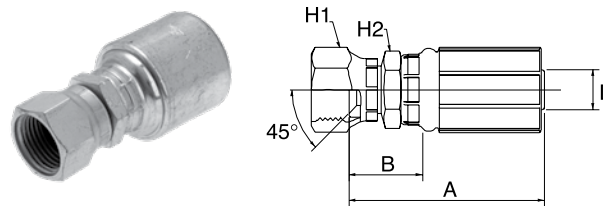

D				A	B	H1	H2	REF.
-size	DN	"		mm	mm	mm	mm	G
-4	6	1/4	7/16" - 20 UNF	48.0	22.0	14.3	12.7	4G4FSX
-4	6	1/4	1/2" - 20 UNF	46.5	20.5	17.5	12.7	4G5FSX
-4	6	1/4	5/8" - 18 UNF	48.5	22.5	19.1	15.9	4G6FSX
-5	8	5/16	5/8" - 18 UNF	52.0	24.0	19.1	15.9	5G6FSX
-6	10	3/8	5/8" - 18 UNF	52.0	24.1	19.1	15.9	6G6FSX
-6	10	3/8	3/4" - 16 UNF	51.5	23.5	22.2	17.5	6G8FSX
-8	12	1/2	3/4" - 16 UNF	60.0	22.5	22.2	20.6	8G8FSX
-8	12	1/2	7/8" - 14 UNF	63.0	25.5	27.0	20.6	8G10FSX
-12	20	3/4	1.1/16" - 14 UNS	78.5	27.5	31.8	27.0	12G12FSX

Unless otherwise stated the coupling meets the pressure rating requirements of the respective international standard.

SAE 45° FSX45

Female SAE swivel. 45° inverted cone.
45° swept elbow.

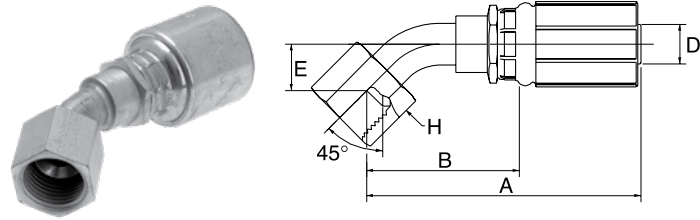

↔			🌀	↔				🔧
D				A	B	E	H	REF.
-size	DN	"		mm	mm	mm	mm	G
-6	10	3/8	5/8" - 18 UNF	69.5	41.6	9.9	19.1	6G6FSX45
-8	12	1/2	3/4" - 16 UNF	84.0	46.5	14.0	22.2	8G8FSX45
-12	20	3/4	1.1/16" - 14 UNS	111.0	60.0	19.8	31.8	12G12FSX45

SAE 45° FSX90

Female SAE swivel. 45° inverted cone.
90° swept elbow.

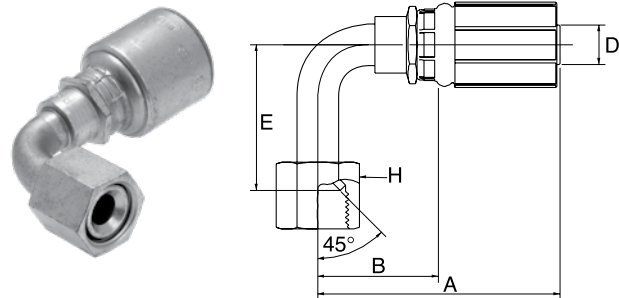

↔			🌀	↔				🔧
D				A	B	E	H	REF.
-size	DN	"		mm	mm	mm	mm	G
-4	6	1/4	7/16" - 20 UNF	52.0	26.0	31.5	14.3	4G4FSX90
-6	10	3/8	5/8" - 18 UNF	60.0	32.1	38.5	19.1	6G6FSX90
-6	10	3/8	3/4" - 16 UNF	63.5	35.6	44.5	22.2	6G8FSX90
-8	12	1/2	3/4" - 16 UNF	74.5	37.0	44.5	22.2	8G8FSX90
-12	20	3/4	1.1/16" - 14 UNS	100.0	49.0	70.5	31.8	12G12FSX90

Unless otherwise stated the coupling meets the pressure rating requirements of the respective international standard.

TABLE OF CONTENTS

ABOUT GATES

HYDRAULIC HOSE

HYDRAULIC HOSE COUPLINGS

ENGINEERING AND TECHNICAL DATA

SAE 45° MS

Male SAE parallel. 45° cone.

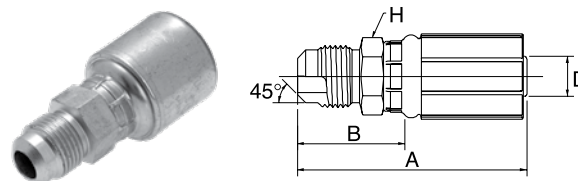

D				A	B	H	REF.
-size	DN	"		mm	mm	mm	G
-4	6	1/4	7/16" - 20 UNF	53.5	27.5	12.7	4G4MS
-6	10	3/8	5/8" - 18 UNF	60.5	32.6	15.9	6G6MS
-8	12	1/2	3/4" - 16 UNF	73.5	36.0	20.6	8G8MS
-8	12	1/2	7/8" - 14 UNF	77.0	39.5	22.2	8G10MS
-12	20	3/4	1.1/16" - 14 UNS	96.0	45.0	27.0	12G12MS

SAE 45° MIX

Male SAE parallel. 45° inverted cone.

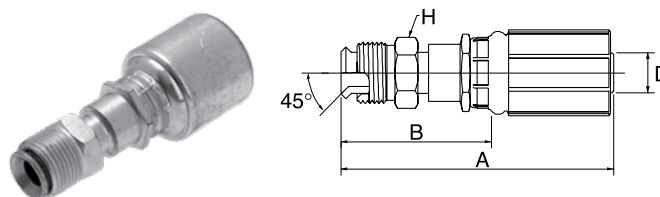

D				A	B	H	REF.
-size	DN	"		mm	mm	mm	G
-4	6	1/4	7/16" - 24 UNS	63.9	37.9	11.1	4G4MIX
-4	6	1/4	1/2" - 20 UNF	63.9	37.9	12.7	4G5MIX
-6	10	3/8	1/2" - 20 UNF	64.9	37.0	12.7	6G5MIX
-6	10	3/8	5/8" - 18 UNF	69.9	42.0	15.9	6G6MIX
-6	10	3/8	11/16" - 18 UNS	70.0	42.1	17.5	6G7MIX
-8	12	1/2	3/4" - 18 UNS	83.8	46.3	19.1	8G8MIX
-10	16	5/8	7/8" - 18 UNS	99.5	62.0	22.2	10G10MIX

Unless otherwise stated the coupling meets the pressure rating requirements of the respective international standard.

SAE 45° MIX45

Male SAE parallel. 45° inverted cone.
45° swept elbow.

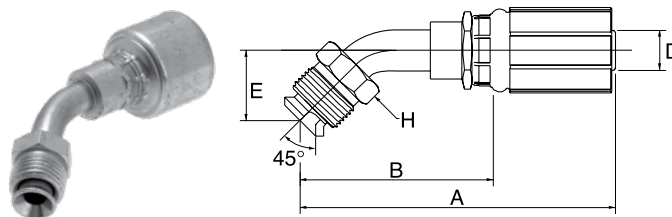

↔			🌀	↔				🔧
D				A	B	E	H	REF.
-size	DN	"		mm	mm	mm	mm	G
-6	10	3/8	7/16" - 24 UNS	80.5	52.6	25.4	11.1	6G4MIX45
-6	10	3/8	1/2" - 20 UNF	79.5	51.6	25.4	12.7	6G5MIX45
-6	10	3/8	5/8" - 18 UNF	84.3	56.4	25.4	15.9	6G6MIX45
-6	10	3/8	11/16" - 18 UNS	86.0	58.1	25.4	17.5	6G7MIX45

SAE 45° MIX90

Male SAE parallel. 45° inverted cone.
90° swept elbow.

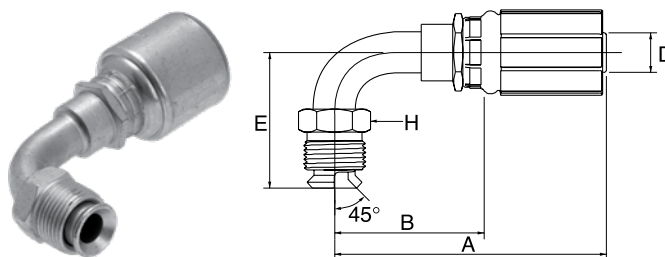

↔			🌀	↔				🔧
D				A	B	E	H	REF.
-size	DN	"		mm	mm	mm	mm	G
-4	6	1/4	7/16" - 24 UNS	59.2	33.2	35.1	11.1	4G4MIX90
-4	6	1/4	1/2" - 20 UNF	62.5	36.5	35.1	12.7	4G5MIX90
-6	10	3/8	7/16" - 24 UNS	62.0	34.1	35.1	11.1	6G4MIX90
-6	10	3/8	1/2" - 20 UNF	63.5	35.6	35.1	12.7	6G5MIX90
-6	10	3/8	5/8" - 18 UNF	71.0	43.1	35.1	15.9	6G6MIX90
-6	10	3/8	11/16" - 18 UNS	71.0	43.1	35.1	17.5	6G7MIX90
-8	12	1/2	3/4" - 18 UNS	83.5	46.0	41.7	19.1	8G8MIX90

Unless otherwise stated the coupling meets the pressure rating requirements of the respective international standard.

TABLE OF CONTENTS

ABOUT GATES

HYDRAULIC HOSE

HYDRAULIC HOSE COUPLINGS

ENGINEERING AND TECHNICAL DATA

SAE 24° MFA

Male SAE parallel. 24° inverted cone.

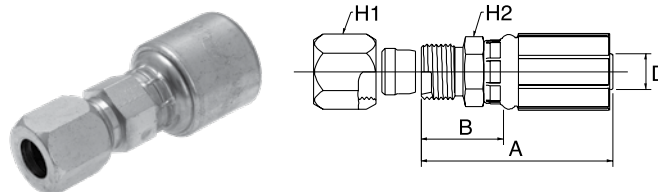

D			7/16" - 20 UNF	A B H1 H2			REF.	
-size	DN	"		mm	mm	mm		mm
-4	6	1/4	7/16" - 20 UNF	53.0	27.0	14.3	12.7	4G4MFA
-4	6	1/4	1/2" - 20 UNF	50.0	24.0	15.9	12.7	4G5MFA
-6	10	3/8	7/16" - 20 UNF	55.0	27.1	14.3	15.9	6G4MFA
-6	10	3/8	1/2" - 20 UNF	55.0	27.1	15.9	15.9	6G5MFA
-6	10	3/8	9/16" - 18 UNF	56.0	28.1	17.5	15.9	6G6MFA
-6	10	3/8	3/4" - 16 UNF	61.0	33.1	22.2	19.1	6G8MFA
-8	12	1/2	3/4" - 16 UNF	70.5	33.0	22.2	20.6	8G8MFA
-8	12	1/2	7/8" - 14 UNF	72.0	34.5	25.4	22.2	8G10MFA
-12	20	3/4	1.1/16" - 12 UN	90.0	39.0	31.8	27.0	12G12MFA
-16	25	1	1.5/16" - 12 UN	100.0	43.2	38.1	34.9	16G16MFA

SAE FL

SAE 'O' ring flange. Code 61.

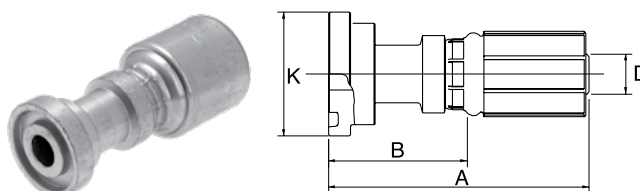

D			1/2" 3/4" 1" 1.1/4" 1.1/2" 1.1/4" 1.1/2"	A B K			KIT	REF.
-size	DN	"		mm	mm	mm		
-8	12	1/2	1/2"	80.0	42.5	30.2	8 PA-FL	8G8FL
-8	12	1/2	3/4"	80.0	42.5	38.1	12 PA-FL	8G12FL
-12	20	3/4	3/4"	98.0	47.0	38.1	12 PA-FL	12G12FL
-12	20	3/4	1"	88.8	37.8	44.5	16 PA-FL	12G16FL
-16	25	1	3/4"	128.0	71.2	38.1	12 PA-FL	16G12FL
-16	25	1	1"	105.0	48.2	44.5	16 PA-FL	16G16FL
-16	25	1	1.1/4"	105.0	48.2	50.8	20 PA-FL	16G20FL
-16	25	1	1.1/2"	96.0	39.2	60.3	24 PA-FL	16G24FL
-20	32	1.1/4	1.1/4"	112.5	53.5	50.8	20 PA-FL	20G20FL
-20	32	1.1/4	1.1/2"	117.5	58.5	60.3	24 PA-FL	20G24FL

Details on flange kits see page 250.

Unless otherwise stated the coupling meets the pressure rating requirements of the respective international standard.

SAE FL22

SAE 'O' ring flange. Code 61.
22° swept elbow.

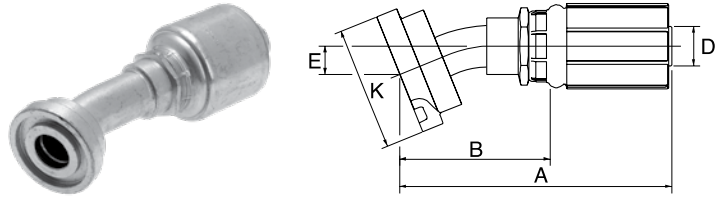

D				A B E K				KIT	REF.
-size	DN	"		mm	mm	mm	mm		G
-12	20	3/4	3/4"	121.0	70.0	11.0	38.1	12 PA-FL	12G12FL22M
-16	25	1	1"	142.5	85.7	14.0	44.5	16 PA-FL	16G16FL22M
-20	32	1.1/4	1.1/4"	152.5	93.5	15.0	50.8	20 PA-FL	20G20FL22M

M: Medium drop per ISO 12151-3. / Details on flange kits see page 250.

SAE FL30

SAE 'O' ring flange. Code 61.
30° swept elbow.

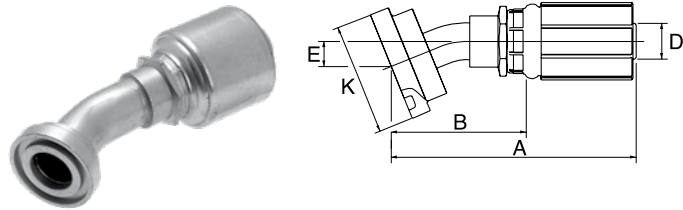

D				A B E K				KIT	REF.
-size	DN	"		mm	mm	mm	mm		G
-16	25	1	1"	144.5	87.7	19.0	44.5	16 PA-FL	16G16FL30M

M: Medium drop per ISO 12151-3. / Details on flange kits see page 250.

Unless otherwise stated the coupling meets the pressure rating requirements of the respective international standard.

TABLE OF CONTENTS

ABOUT GATES

HYDRAULIC HOSE

HYDRAULIC HOSE COUPLINGS

ENGINEERING AND TECHNICAL DATA

SAE FL45

SAE 'O' ring flange. Code 61.
45° swept elbow.

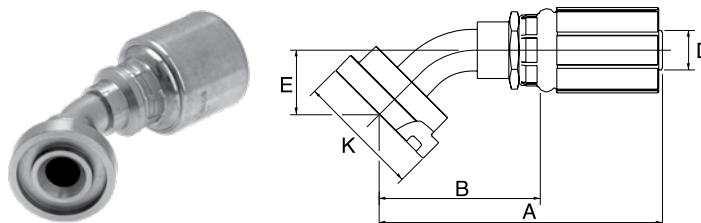

D				A	B	E	K	KIT	REF.
-size	DN	"		mm	mm	mm	mm		G
-8	12	1/2	1/2"	86.2	48.9	19.1	30.2	8 PA-FL	8G8FL45M
-8	12	1/2	3/4"	104.8	67.3	26.0	38.1	12 PA-FL	8G12FL45M
-12	20	3/4	3/4"	107.2	56.2	26.6	38.1	12 PA-FL	12G12FL45M
-12	20	3/4	1"	124.5	73.5	28.0	44.5	16 PA-FL	12G16FL45S
-16	25	1	3/4"	118.7	61.9	26.6	38.1	12 PA-FL	16G12FL45
-16	25	1	1"	142.5	85.7	28.0	44.5	16 PA-FL	16G16FL45S
-16	25	1	1.1/4"	149.0	92.2	32.0	50.8	20 PA-FL	16G20FL45S
-20	32	1.1/4	1.1/4"	157.0	98.0	32.0	50.8	20 PA-FL	20G20FL45S
-20	32	1.1/4	1.1/2"	146.8	87.8	32.0	60.3	24 PA-FL	20G24FL45-032

S: Short drop - M: Medium drop per ISO 12151-3. / Details on flange kits see page 250.

SAE FL60

SAE 'O' ring flange. Code 61.
60° swept elbow.

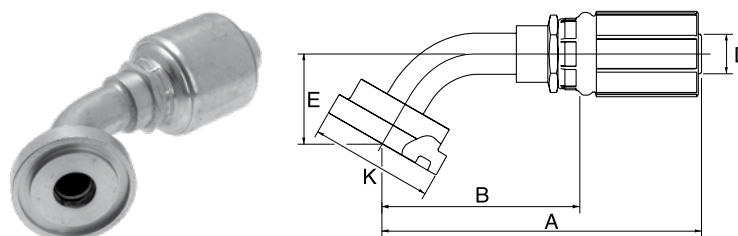

D				A	B	E	K	KIT	REF.
-size	DN	"		mm	mm	mm	mm		G
-12	20	3/4	3/4"	128.0	77.0	37.0	38.1	12 PA-FL	12G12FL60M
-12	20	3/4	1"	132.0	81.0	44.0	44.5	16 PA-FL	12G16FL60M

M: Medium drop per ISO 12151-3. / Details on flange kits see page 250.

Unless otherwise stated the coupling meets the pressure rating requirements of the respective international standard.

SAE FL90

SAE 'O' ring flange. Code 61.
90° swept elbow.

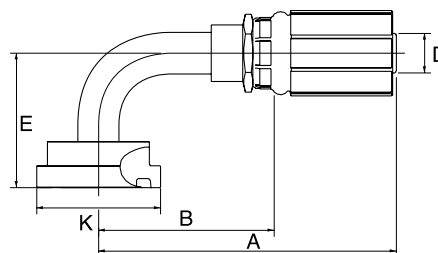

D				A	B	E	K	KIT	REF.
-size	DN	"		mm	mm	mm	mm		G
-8	12	1/2	1/2"	91.2	53.7	40.0	30.2	8 PA-FL	8G8FL90M
-8	12	1/2	3/4"	91.5	54.0	58.0	38.1	12 PA-FL	8G12FL90M
-10	16	5/8	3/4"	101.8	64.3	58.0	38.1	12 PA-FL	10G12FL90M
-12	20	3/4	3/4"	97.3	46.3	54.4	38.1	12 PA-FL	12G12FL90-054
-12	20	3/4	1"	119.8	68.8	61.0	44.5	16 PA-FL	12G16FL90S
-16	25	1	3/4"	108.8	52.0	54.4	38.1	12 PA-FL	16G12FL90-054
-16	25	1	1"	139.3	82.5	61.0	44.5	16 PA-FL	16G16FL90S
-16	25	1	1.1/4"	139.3	82.5	68.0	50.8	20 PA-FL	16G20FL90S
-16	25	1	1.1/2"	118.2	61.4	61.6	60.3	24 PA-FL	16G24FL90
-20	32	1.1/4	1"	122.1	63.1	61.8	44.5	16 PA-FL	20G16FL90S
-20	32	1.1/4	1.1/4"	158.1	99.1	68.0	50.8	20 PA-FL	20G20FL90S
-20	32	1.1/4	1.1/2"	158.1	99.1	81.0	60.3	24 PA-FL	20G24FL90S

S: Short drop - M: Medium drop per ISO 12151-3. / Details on flange kits see page 250.

SAE FLH90

SAE 'O' ring flange high-pressure.
Code 62. 90° swept elbow.

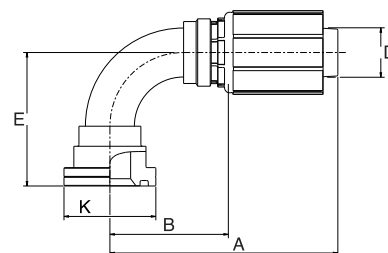

D				A	B	E	K	KIT	REF.
-size	DN	"		mm	mm	mm	mm		G
-8	12	1/2	1/2"	78.0	40.5	41.9	31.8	8 PH-FLH	8G8FLH90M
-12	20	3/4	3/4"	121.0	70.0	58.0	41.3	12 PH-FLH	12G12FLH90M
-16	25	1	1"	118.2	61.4	69.2	47.6	16 PH-FLH	16G16FLH90

Unless otherwise stated the coupling meets the pressure rating requirements of the respective international standard.

TABLE OF CONTENTS

ABOUT GATES

HYDRAULIC HOSE

HYDRAULIC HOSE COUPLINGS

ENGINEERING AND TECHNICAL DATA

FLK

Komatsu type 'O' ring flange.

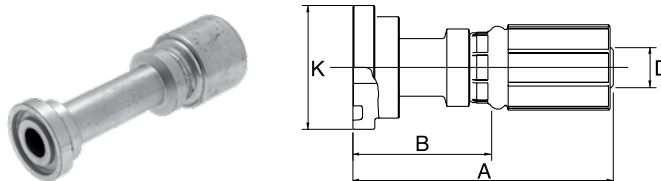

D				A	B	K	REF.
-size	DN	"		mm	mm	mm	G
-8	12	1/2	5/8"	80.0	42.5	34.2	8G10FLK
-10	16	5/8	5/8"	119.0	81.5	34.2	10G10FLK

FLK45

Komatsu type 'O' ring flange.

45° swept elbow.

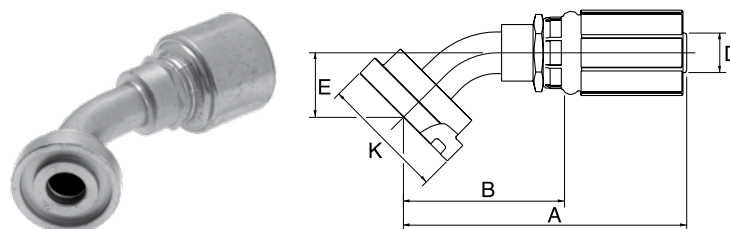

D				A	B	E	K	REF.
-size	DN	"		mm	mm	mm	mm	G
-10	16	5/8	5/8"	106.5	69.0	26.0	34.2	10G10FLK45

Unless otherwise stated the coupling meets the pressure rating requirements of the respective international standard.

FLK90

Komatsu type 'O' ring flange.
90° swept elbow.

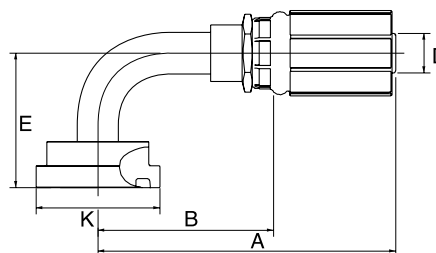

D			5/8"	A	B	E	K	REF.
-size	DN	"		mm	mm	mm	mm	G
-10	16	5/8	5/8"	99.0	61.5	55.0	34.2	10G10FLK90

TABLE OF CONTENTS

ABOUT GATES

HYDRAULIC HOSE

HYDRAULIC HOSE COUPLINGS

ENGINEERING AND TECHNICAL DATA

Unless otherwise stated the coupling meets the pressure rating requirements of the respective international standard.

DIN 24° FDLORX

Female DIN 'O' ring swivel. 24° cone.
Light series.

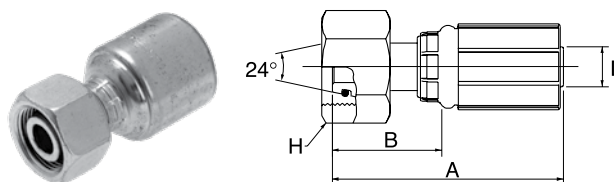

D				A	B	H	REF.
-size	DN	"		mm	mm	mm	G
-4	6	1/4	M12 x 1.5	50.5	24.5	14.0	4G6FDLORX
-4	6	1/4	M14 x 1.5	52.5	26.5	17.0	4G8FDLORX
-4	6	1/4	M16 x 1.5	53.5	27.5	19.0	4G10FDLORX
-4	6	1/4	M18 x 1.5	52.5	26.5	22.0	4G12FDLORX
-5	8	5/16	M14 x 1.5	52.0	28.4	17.0	5G8FDLORX
-5	8	5/16	M16 x 1.5	53.9	29.7	19.0	5G10FDLORX
-5	8	5/16	M18 x 1.5	58.5	30.0	22.0	5G12FDLORX
-6	10	3/8	M16 x 1.5	55.0	27.1	19.0	6G10FDLORX
-6	10	3/8	M18 x 1.5	55.5	27.6	22.0	6G12FDLORX
-6	10	3/8	M20 x 1.5	58.0	30.1	24.0	6G14FDLORX
-6	10	3/8	M22 x 1.5	54.0	26.1	27.0	6G15FDLORX
-8	12	1/2	M18 x 1.5	69.9	32.4	22.0	8G12FDLORX
-8	12	1/2	M22 x 1.5	63.5	26.0	27.0	8G15FDLORX
-8	12	1/2	M26 x 1.5	65.0	27.5	32.0	8G18FDLORX
-10	16	5/8	M22 x 1.5	68.0	30.5	27.0	10G15FDLORX
-10	16	5/8	M26 x 1.5	67.0	29.5	32.0	10G18FDLORX
-10	16	5/8	M30 x 2.0	65.0	27.5	36.0	10G22FDLORX
-12	20	3/4	M26 x 1.5	81.5	30.5	32.0	12G18FDLORX
-12	20	3/4	M30 x 2.0	83.5	32.5	36.0	12G22FDLORX
-16	25	1	M36 x 2.0	81.6	36.7	41.0	16G28FDLORX
-20	32	1.1/4	M45 x 2.0	90.4	44.1	50.0	20G35FDLORX

-4 size is 42.0 MPa (6000 psi); -5 & -6 size are 38.5 MPa (5500 psi); -8 size is 35.0 MPa (5000psi); 10 & -12 size are 28.0 MPa (4000 psi);
-16 size is 22.4 MPa (3200 psi); -20 size is 16.0 MPa (2300 psi).

Unless otherwise stated the coupling meets the pressure rating requirements of the respective international standard.

TABLE OF CONTENTS

ABOUT GATES

HYDRAULIC HOSE

HYDRAULIC HOSE COUPLINGS

ENGINEERING AND TECHNICAL DATA

DIN 24° FDLORX45

Female DIN 'O' ring swivel. 24° cone.
Light series. 45° swept elbow.

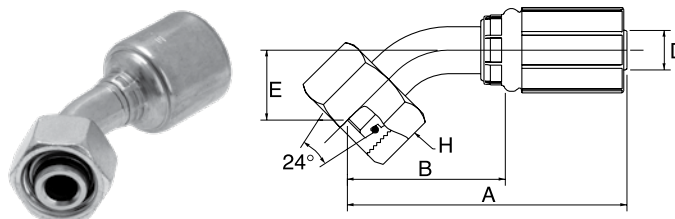

↻			🌀	↔				📏
D				A	B	E	H	REF.
-size	DN	"		mm	mm	mm	mm	G
-4	6	1/4	M12 x 1.5	65.8	39.7	16.9	14.0	4G6FDLORX45
-4	6	1/4	M14 x 1.5	65.1	39.0	16.2	17.0	4G8FDLORX45
-4	6	1/4	M16 x 1.5	66.9	40.8	17.9	19.0	4G10FDLORX45
-4	6	1/4	M18 x 1.5	67.2	41.2	18.3	22.0	4G12FDLORX45
-5	8	5/16	M14 x 1.5	67.1	39.1	16.9	17.0	5G8FDLORX45
-5	8	5/16	M16 x 1.5	63.4	39.3	17.1	19.0	5G10FDLORX45
-5	8	5/16	M18 x 1.5	67.7	39.7	18.9	22.0	5G12FDLORX45
-6	10	3/8	M16 x 1.5	68.5	40.5	18.6	19.0	6G10FDLORX45
-6	10	3/8	M18 x 1.5	68.8	40.9	18.9	22.0	6G12FDLORX45
-6	10	3/8	M22 x 1.5	72.3	44.4	22.5	27.0	6G15FDLORX45
-8	12	1/2	M18 x 1.5	80.3	42.9	18.9	22.0	8G12FDLORX45
-8	12	1/2	M22 x 1.5	84.4	47.0	20.2	27.0	8G15FDLORX45
-8	12	1/2	M26 x 1.5	94.6	57.1	26.9	32.0	8G18FDLORX45
-10	16	5/8	M22 x 1.5	89.7	52.2	21.4	27.0	10G15FDLORX45
-10	16	5/8	M26 x 1.5	93.5	56.2	24.8	32.0	10G18FDLORX45
-12	20	3/4	M30 x 2.0	117.1	66.1	29.8	36.0	12G22FDLORX45
-16	25	1	M36 x 2.0	123.7	78.8	30.9	41.0	16G28FDLORX45
-20	32	1.1/4	M45 x 2.0	161.9	102.9	37.5	50.0	20G35FDLORX45

-4 size is 42.0 MPa (6000 psi); -5 & -6 size are 38.5 MPa (5500 psi); -8 size is 35.0 MPa (5000psi); 10 & -12 size are 28.0 MPa (4000 psi); -16 size is 22.4 MPa (3200 psi); -20 size is 16.0 MPa (2300 psi).

Unless otherwise stated the coupling meets the pressure rating requirements of the respective international standard.

TABLE OF CONTENTS

ABOUT GATES

HYDRAULIC HOSE

HYDRAULIC HOSE COUPLINGS

ENGINEERING AND TECHNICAL DATA

DIN 24° FDLORX90

Female DIN 'O' ring swivel. 24° cone.
Light series. 90° swept elbow.

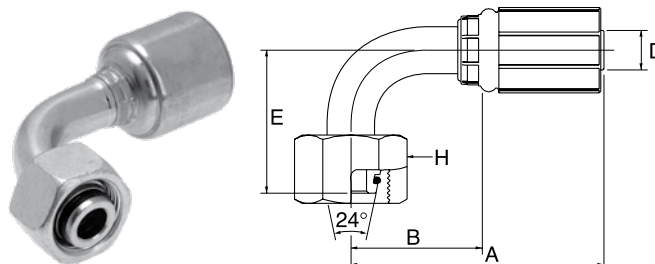

↻			🌀	↔				📏
D				A	B	E	H	REF.
-size	DN	"		mm	mm	mm	mm	G
-4	6	1/4	M12 x 1.5	60.0	34.0	35.0	14.0	4G6FDLORX90
-4	6	1/4	M14 x 1.5	60.0	34.0	35.0	17.0	4G8FDLORX90
-4	6	1/4	M16 x 1.5	60.0	34.0	36.5	19.0	4G10FDLORX90
-4	6	1/4	M18 x 1.5	60.0	34.0	37.0	22.0	4G12FDLORX90
-5	8	5/16	M14 x 1.5	61.4	33.4	35.0	17.0	5G8FDLORX90
-5	8	5/16	M16 x 1.5	58.6	34.4	36.5	19.0	5G10FDLORX90
-5	8	5/16	M18 x 1.5	59.0	31.0	37.0	22.0	5G12FDLORX90
-6	10	3/8	M16 x 1.5	60.1	32.2	36.5	19.0	6G10FDLORX90
-6	10	3/8	M18 x 1.5	60.1	32.2	37.0	22.0	6G12FDLORX90
-6	10	3/8	M22 x 1.5	60.1	32.2	42.0	27.0	6G15FDLORX90
-8	12	1/2	M18 x 1.5	71.7	34.2	37.0	22.0	8G12FDLORX90
-8	12	1/2	M22 x 1.5	77.8	40.3	42.0	27.0	8G15FDLORX90
-8	12	1/2	M26 x 1.5	81.4	43.9	51.5	32.0	8G18FDLORX90
-10	16	5/8	M22 x 1.5	80.0	42.5	42.0	27.0	10G15FDLORX90
-10	16	5/8	M26 x 1.5	85.1	47.8	51.5	32.0	10G18FDLORX90
-12	20	3/4	M26 x 1.5	100.3	49.3	51.5	32.0	12G18FDLORX90
-12	20	3/4	M30 x 2.0	107.3	56.3	62.0	36.0	12G22FDLORX90
-16	25	1	M36 x 2.0	119.2	74.3	70.0	41.0	16G28FDLORX90
-20	32	1.1/4	M45 x 2.0	151.4	92.4	80.0	50.0	20G35FDLORX90

-4 size is 42.0 MPa (6000 psi); -5 & -6 size are 38.5 MPa (5500 psi); -8 size is 35.0 MPa (5000psi); 10 & -12 size are 28.0 MPa (4000 psi); -16 size is 22.4 MPa (3200 psi); -20 size is 16.0 MPa (2300 psi).

Unless otherwise stated the coupling meets the pressure rating requirements of the respective international standard.

DIN 24° FDLORX180

Female DIN 'O' ring swivel. 24° cone.
Light series. 180° swept elbow.

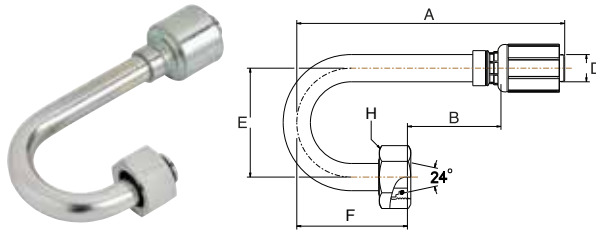

D			M26 x 2.0	A B E F H					REF.
-size	DN	"		mm	mm	mm	mm	mm	G
-10	16	5/8	M26 x 2.0	157.5	55.0	64.0	65.0	32.0	10G18FDLORX180

DIN 24° MDL

Male DIN parallel. 24° inverted cone.
Light series.

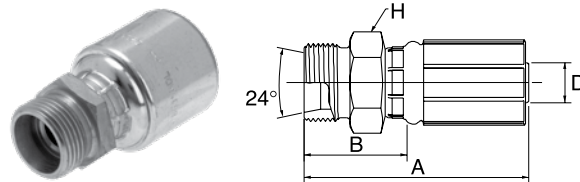

D			M12 x 1.5 M14 x 1.5 M16 x 1.5 M18 x 1.5 M14 x 1.5 M16 x 1.5 M18 x 1.5 M16 x 1.5 M18 x 1.5 M22 x 1.5 M18 x 1.5 M22 x 1.5 M26 x 1.5 M18 x 1.5 M22 x 1.5 M26 x 1.5 M30 x 2.0 M36 x 2.0 M45 x 2.0	A B H			REF.
-size	DN	"		mm	mm	mm	G
-4	6	1/4	M12 x 1.5	44.0	20.9	14.0	4G6MDL
-4	6	1/4	M14 x 1.5	45.0	21.9	17.0	4G8MDL
-4	6	1/4	M16 x 1.5	45.9	22.8	17.0	4G10MDL
-4	6	1/4	M18 x 1.5	47.0	23.9	19.0	4G12MDL
-5	8	5/16	M14 x 1.5	44.7	20.8	17.0	5G8MDL
-5	8	5/16	M16 x 1.5	45.9	21.8	17.0	5G10MDL
-5	8	5/16	M18 x 1.5	46.7	22.8	19.0	5G12MDL
-6	10	3/8	M16 x 1.5	51.0	23.1	17.0	6G10MDL
-6	10	3/8	M18 x 1.5	52.0	24.1	19.0	6G12MDL
-6	10	3/8	M22 x 1.5	53.0	25.1	24.0	6G15MDL
-8	12	1/2	M18 x 1.5	61.5	24.0	22.0	8G12MDL
-8	12	1/2	M22 x 1.5	62.5	25.0	24.0	8G15MDL
-8	12	1/2	M26 x 1.5	65.5	28.0	27.0	8G18MDL
-10	16	5/8	M26 x 1.5	64.0	26.5	27.0	10G18MDL
-12	20	3/4	M26 x 1.5	78.0	27.0	27.0	12G18MDL
-12	20	3/4	M30 x 2.0	80.0	29.0	32.0	12G22MDL
-16	25	1	M36 x 2.0	76.3	30.4	41.0	16G28MDL
-20	32	1.1/4	M45 x 2.0	80.4	35.1	46.0	20G35MDL

-4 size is 42.0 MPa (6000 psi); -5 & -6 size are 38.5 MPa (5500 psi); -8 size is 35.0 MPa (5000psi); 10 & -12 size are 28.0 MPa (4000 psi); -16 size is 22.4 MPa (3200 psi); -20 size is 16.0 MPa (2300 psi).

Unless otherwise stated the coupling meets the pressure rating requirements of the respective international standard.

TABLE OF CONTENTS

ABOUT GATES

HYDRAULIC HOSE

HYDRAULIC HOSE COUPLINGS

ENGINEERING AND TECHNICAL DATA

DIN 24° FDHORX

Female DIN 'O' ring swivel. 24° cone.
Heavy series.

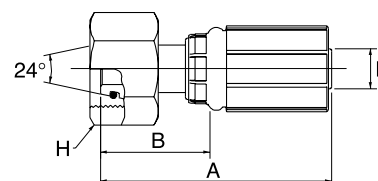

D				A	B	H	REF.
-size	DN	"		mm	mm	mm	G
-4	6	1/4	M14 x 1.5	50.5	24.5	17.0	4G6FDHORX
-4	6	1/4	M16 x 1.5	52.5	26.5	19.0	4G8FDHORX
-4	6	1/4	M18 x 1.5	53.5	27.5	22.0	4G10FDHORX
-4	6	1/4	M20 x 1.5	52.5	26.5	24.0	4G12FDHORX
-5	8	5/16	M16 x 1.5	56.4	28.4	19.0	5G8FDHORX
-5	8	5/16	M18 x 1.5	54.1	29.9	22.0	5G10FDHORX
-5	8	5/16	M20 x 1.5	58.0	30.0	24.0	5G12FDHORX
-5	8	5/16	M22 x 1.5	53.6	30.0	27.0	5G14FDHORX
-6	10	3/8	M18 x 1.5	55.0	27.1	22.0	6G10FDHORX
-6	10	3/8	M20 x 1.5	55.5	27.6	24.0	6G12FDHORX
-6	10	3/8	M22 x 1.5	58.0	30.1	27.0	6G14FDHORX
-6	10	3/8	M24 x 1.5	52.5	24.6	30.0	6G16FDHORX
-8	12	1/2	M20 x 1.5	69.9	32.4	24.0	8G12FDHORX
-8	12	1/2	M22 x 1.5	68.0	30.5	27.0	8G14FDHORX
-8	12	1/2	M24 x 1.5	69.0	31.5	30.0	8G16FDHORX
-8	12	1/2	M30 x 2.0	70.0	32.5	36.0	8G20FDHORX
-10	16	5/8	M24 x 1.5	71.0	33.5	30.0	10G16FDHORX
-10	16	5/8	M30 x 2.0	73.0	35.5	36.0	10G20FDHORX
-12	20	3/4	M30 x 2.0	89.5	38.5	36.0	12G20FDHORX
-12	20	3/4	M36 x 2.0	90.0	39.0	46.0	12G25FDHORX
-16	25	1	M36 x 2.0	102.5	45.7	46.0	16G25FDHORX
-16	25	1	M42 x 2.0	94.1	49.2	50.0	16G30FDHORX
-20	32	1.1/4	M52 x 2.0	104.1	57.8	60.0	20G38FDHORX

Unless otherwise stated the coupling meets the pressure rating requirements of the respective international standard.

DIN 24° FDHORX45

Female DIN 'O' ring swivel. 24° cone.
Heavy series. 45° swept elbow.

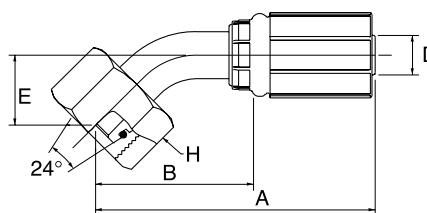

↻			🌀	↔				📏
D				A	B	E	H	REF.
-size	DN	"		mm	mm	mm	mm	G
-4	6	1/4	M14 x 1.5	65.8	39.7	16.9	17.0	4G6FDHORX45
-4	6	1/4	M16 x 1.5	65.1	39.0	16.2	19.0	4G8FDHORX45
-4	6	1/4	M18 x 1.5	66.9	40.8	17.9	22.0	4G10FDHORX45
-4	6	1/4	M20 x 1.5	67.2	41.2	18.3	24.0	4G12FDHORX45
-5	8	5/16	M18 x 1.5	63.3	39.3	17.1	22.0	5G10FDHORX45
-5	8	5/16	M20 x 1.5	67.7	39.7	18.9	24.0	5G12FDHORX45
-6	10	3/8	M18 x 1.5	68.5	40.5	18.6	22.0	6G10FDHORX45
-6	10	3/8	M20 x 1.5	68.8	40.9	18.9	24.0	6G12FDHORX45
-6	10	3/8	M22 x 1.5	70.9	43.0	21.0	27.0	6G14FDHORX45
-8	12	1/2	M20 x 1.5	91.7	54.2	19.7	24.0	8G12FDHORX45
-8	12	1/2	M22 x 1.5	91.3	53.9	27.1	27.0	8G14FDHORX45
-8	12	1/2	M24 x 1.5	85.9	48.4	21.6	30.0	8G16FDHORX45
-10	16	5/8	M30 x 2.0	93.1	55.8	24.9	36.0	10G20FDHORX45
-12	20	3/4	M30 x 2.0	109.4	58.4	24.9	36.0	12G20FDHORX45
-12	20	3/4	M36 x 2.0	118.6	67.6	31.2	46.0	12G25FDHORX45
-16	25	1	M36 x 2.0	146.5	89.7	35.1	46.0	16G25FDHORX45
-16	25	1	M42 x 2.0	139.8	83.0	35.1	50.0	16G30FDHORX45
-20	32	1.1/4	M52 x 2.0	166.9	107.9	42.5	60.0	20G38FDHORX45

Unless otherwise stated the coupling meets the pressure rating requirements of the respective international standard.

DIN 24° FDHORX90

Female DIN 'O' ring swivel. 24° cone.
Heavy series. 90° swept elbow.

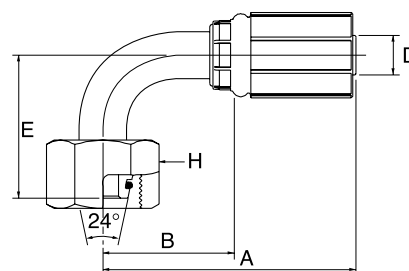

D			M	A B E H				REF. G
-size	DN	"		mm	mm	mm	mm	
-4	6	1/4	M14 x 1.5	60.0	34.0	35.0	17.0	4G6FDHORX90
-4	6	1/4	M16 x 1.5	60.0	34.0	35.0	19.0	4G8FDHORX90
-4	6	1/4	M18 x 1.5	60.0	34.0	36.5	22.0	4G10FDHORX90
-4	6	1/4	M20 x 1.5	60.0	34.0	37.0	24.0	4G12FDHORX90
-5	8	5/16	M18 x 1.5	58.5	34.4	36.5	22.0	5G10FDHORX90
-5	8	5/16	M20 x 1.5	59.0	31.0	37.0	24.0	5G12FDHORX90
-5	8	5/16	M22 x 1.5	54.6	31.0	40.0	27.0	5G14FDHORX90
-6	10	3/8	M18 x 1.5	60.1	32.2	36.5	22.0	6G10FDHORX90
-6	10	3/8	M20 x 1.5	60.1	32.2	37.0	24.0	6G12FDHORX90
-6	10	3/8	M22 x 1.5	60.3	32.4	40.0	27.0	6G14FDHORX90
-8	12	1/2	M20 x 1.5	73.1	35.7	53.1	24.0	8G12FDHORX90
-8	12	1/2	M22 x 1.5	79.0	41.6	51.0	27.0	8G14FDHORX90
-8	12	1/2	M24 x 1.5	77.8	40.3	44.0	30.0	8G16FDHORX90
-8	12	1/2	M24 x 1.5	93.2	55.8	90.0	30.0	8G16FDHORX90-090
-10	16	5/8	M30 x 2.0	84.1	46.8	51.0	36.0	10G20FDHORX90
-10	16	5/8	M36 x 2.0	84.1	46.8	64.0	46.0	10G25FDHORX90
-12	20	3/4	M30 x 2.0	100.3	49.3	51.0	36.0	12G20FDHORX90
-12	20	3/4	M36 x 2.0	107.3	56.3	64.0	46.0	12G25FDHORX90
-16	25	1	M36 x 2.0	137.8	81.0	76.0	46.0	16G25FDHORX90
-16	25	1	M42 x 2.0	119.2	74.3	76.0	50.0	16G30FDHORX90
-20	32	1.1/4	M52 x 2.0	151.4	92.4	87.0	60.0	20G38FDHORX90

Unless otherwise stated the coupling meets the pressure rating requirements of the respective international standard.

DIN 24° MDH

Male DIN parallel. 24° inverted cone.
Heavy series.

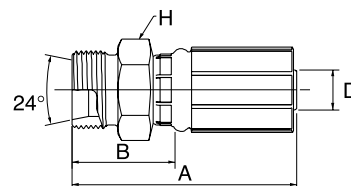

↻			🌀	↔			📏
D				A	B	H	REF.
-size	DN	"		mm	mm	mm	G
-4	6	1/4	M14 x 1.5	50.8	24.8	14.0	4G6MDH
-4	6	1/4	M16 x 1.5	53.0	27.0	17.0	4G8MDH
-4	6	1/4	M18 x 1.5	52.5	26.5	19.0	4G10MDH
-5	8	5/16	M18 x 1.5	49.7	25.8	19.0	5G10MDH
-5	8	5/16	M20 x 1.5	51.9	27.8	22.0	5G12MDH
-6	10	3/8	M18 x 1.5	55.0	27.1	19.0	6G10MDH
-6	10	3/8	M20 x 1.5	57.5	29.6	24.0	6G12MDH
-6	10	3/8	M22 x 1.5	59.5	31.6	24.0	6G14MDH
-8	12	1/2	M20 x 1.5	66.5	29.0	24.0	8G12MDH
-8	12	1/2	M22 x 1.5	68.0	30.5	24.0	8G14MDH
-8	12	1/2	M24 x 1.5	69.0	31.5	27.0	8G16MDH
-8	12	1/2	M30 x 2.0	72.5	35.0	32.0	8G20MDH
-10	16	5/8	M24 x 1.5	69.0	31.5	27.0	10G16MDH
-10	16	5/8	M30 x 2.0	73.0	35.5	32.0	10G20MDH
-12	20	3/4	M30 x 2.0	87.0	36.0	32.0	12G20MDH
-12	20	3/4	M36 x 2.0	91.0	40.0	41.0	12G25MDH
-16	25	1	M36 x 2.0	86.3	40.4	41.0	16G25MDH
-16	25	1	M42 x 2.0	88.3	42.4	46.0	16G30MDH
-20	32	1.1/4	M52 X 2.0	94.4	49.1	55.0	20G38MDH

DIN 24° MDH180

Male DIN parallel. 24° inverted cone.
Heavy series. 180° swept elbow.

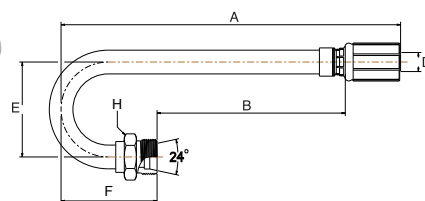

↻			🌀	↔					📏
D				A	B	E	F	H	REF.
-size	DN	"		mm	mm	mm	mm	mm	G
-8	12	1/2	M24 x 1.5	165.0	127.5	64.0	65.0	27.0	8G16MDH180-110

-8: MWP 24.5 MPa (3500 psi).

Unless otherwise stated the coupling meets the pressure rating requirements of the respective international standard.

DIN 24° / 60° FDLX

Female DIN swivel. 24°/60° cone.
Light series.

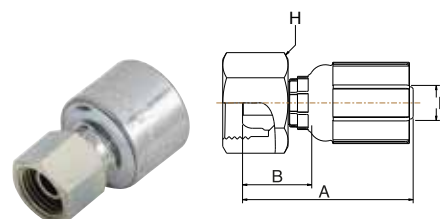

↻			🌀	↔			📏
D				A	B	H	REF.
-size	DN	"		mm	mm	mm	G
-4	6	1/4	M16 x 1.5	45.5	19.5	19.0	4G10FDLX
-4	6	1/4	M18 x 1.5	44.0	18.0	22.0	4G12FDLX
-6	10	3/8	M16 x 1.5	47.0	19.1	22.0	6G10FDLX
-6	10	3/8	M18 x 1.5	47.0	19.1	19.0	6G12FDLX
-6	10	3/8	M22 x 1.5	46.5	18.6	22.0	6G15FDLX

DIN 24° / 60° FDHX

Female DIN swivel. 24°/60° cone.
Heavy series.

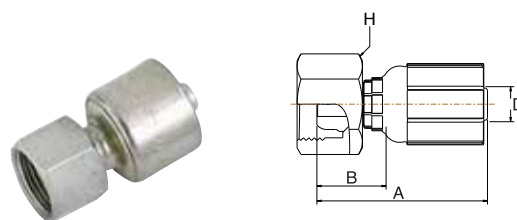

↻			🌀	↔			📏
D				A	B	H	REF.
-size	DN	"		mm	mm	mm	G
-6	10	3/8	M18 x 1.5	47.0	19.1	27.0	6G12FDHX
-6	10	3/8	M22 x 1.5	47.5	19.6	27.0	6G14FDHX

Unless otherwise stated the coupling meets the pressure rating requirements of the respective international standard.



METRIC MSP

Metric standpipe.

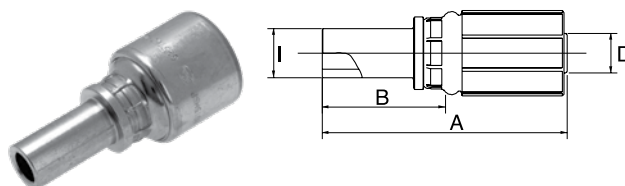

↻			↔			🔧
D			I	A	B	REF.
-size	DN	"	mm	mm	mm	G
-4	6	1/4	L6	62.5	36.5	4G6MSP
-4	6	1/4	L8	62.5	36.5	4G8MSP
-4	6	1/4	L10	64.5	38.5	4G10MSP
-5	8	5/16	L8	64.5	36.5	5G8MSP
-5	8	5/16	L10	66.5	38.5	5G10MSP
-5	8	5/16	L12	66.5	38.5	5G12MSP
-6	10	3/8	L10	67.5	39.6	6G10MSP
-6	10	3/8	L12	67.5	39.6	6G12MSP
-8	12	1/2	L15	77.3	39.8	8G15MSP
-10	16	5/8	L18	77.0	39.5	10G18MSP
-12	20	3/4	L22	93.0	42.0	12G22MSP

Unless otherwise stated the coupling meets the pressure rating requirements of the respective international standard.

TABLE OF CONTENTS

ABOUT GATES

HYDRAULIC HOSE

HYDRAULIC HOSE COUPLINGS

ENGINEERING AND TECHNICAL DATA

METRIC DBJ

Metric banjo.

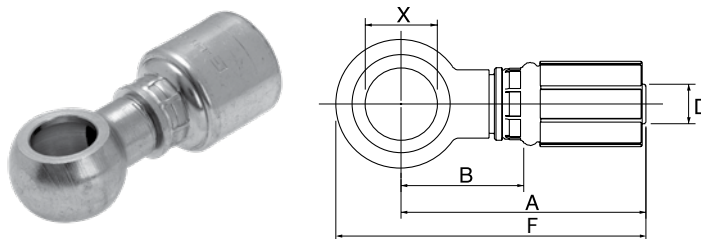

↻			⊕	↔				⊞
D				A	B	F	X	REF.
-size	DN	"		mm	mm	mm	mm	G
-4	6	1/4	M10	52.3	26.3	60.8	10.1	4G10DBJ
-4	6	1/4	M12	54.3	28.3	64.3	12.1	4G12DBJ
-4	6	1/4	M14	56.3	30.3	68.3	14.1	4G14DBJ
-4	6	1/4	M16	58.3	32.3	72.3	16.1	4G16DBJ
-4	6	1/4	M18	60.3	34.3	76.3	18.1	4G18DBJ
-5	8	5/16	M12	56.2	28.2	66.2	12.1	5G12DBJ
-5	8	5/16	M14	58.2	30.2	70.2	14.1	5G14DBJ
-5	8	5/16	M16	60.2	32.2	74.2	16.1	5G16DBJ
-5	8	5/16	M18	62.2	34.2	78.2	18.1	5G18DBJ
-6	10	3/8	M12	56.0	28.1	66.0	12.1	6G12DBJ
-6	10	3/8	M14	58.3	30.4	70.3	14.2	6G14DBJ
-6	10	3/8	M16	60.3	32.4	74.0	16.2	6G16DBJ
-6	10	3/8	M18	62.3	34.4	78.3	18.2	6G18DBJ
6	10	3/8	M22	63.8	35.9	83.3	22.1	6G22DBJ
-8	12	1/2	M18	72.2	34.7	88.2	18.1	8G18DBJ
-8	12	1/2	M22	75.7	38.2	95.2	22.1	8G22DBJ
-10	16	5/8	M22	76.2	38.7	95.7	22.1	10G22DBJ
-10	16	5/8	M26	79.3	41.8	102.3	26.1	10G26DBJ
-12	20	3/4	M22	89.2	38.2	108.7	22.1	12G22DBJ
-12	20	3/4	M26	94.7	43.7	117.7	26.1	12G26DBJ
-16	25	1	M30	109.2	52.4	136.2	30.1	16G30DBJ

-4 to -16 size are 20.0 MPa (2900 psi), these maximum working pressure values are a guidance for the banjo body only, selection of sealing type and applied torque on banjo bolt can influence overall connection performance.

Unless otherwise stated the coupling meets the pressure rating requirements of the respective international standard.

NPTF FPX

Female NPSM pipe swivel. 30° cone.

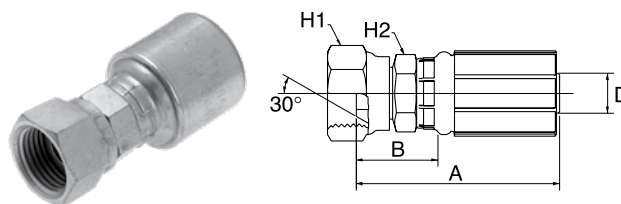

D				A B H1 H2				REF.
-size	DN	"		mm	mm	mm	mm	G
-4	6	1/4	1/4" - 18 NPSM	51.0	25.0	17.5	12.7	4G4FPX
-6	10	3/8	3/8" - 18 NPSM	56.0	28.1	22.2	15.9	6G6FPX
-8	12	1/2	1/2" - 14 NPSM	64.5	27.0	25.4	20.7	8G8FPX
-12	20	3/4	3/4" - 14 NPSM	84.5	33.5	31.8	27.0	12G12FPX
-16	25	1	1" - 11.5 NPSM	94.0	37.2	38.1	34.9	16G16FPX

Unless otherwise stated the coupling meets the pressure rating requirements of the respective international standard.

TABLE OF CONTENTS

ABOUT GATES

HYDRAULIC HOSE

HYDRAULIC HOSE COUPLINGS

ENGINEERING AND TECHNICAL DATA

NPTF MP

Male NPTF pipe.

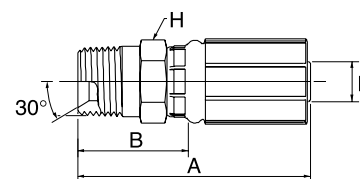

D				A	B	H	REF.
-size	DN	"		mm	mm	mm	G
-4	6	1/4	1/8" - 27 NPTF	50.0	24.0	12.7	4G2MP
-4	6	1/4	1/4" - 18 NPTF	55.0	29.0	14.3	4G4MP
-4	6	1/4	3/8" - 18 NPTF	55.0	29.0	17.5	4G6MP
-4	6	1/4	1/2" - 14 NPTF	62.0	36.0	22.2	4G8MP
-5	8	5/16	1/4" - 18 NPTF	58.0	30.0	15.9	5G4MP
-5	8	5/16	3/8" - 18 NPTF	59.0	31.0	17.5	5G6MP
-6	10	3/8	1/4" - 18 NPTF	59.0	31.1	15.9	6G4MP
-6	10	3/8	3/8" - 18 NPTF	59.0	31.1	17.5	6G6MP
-6	10	3/8	1/2" - 14 NPTF	64.0	36.1	22.2	6G8MP
-8	12	1/2	3/8" - 18 NPTF	69.0	31.5	20.6	8G6MP
-8	12	1/2	1/2" - 14 NPTF	73.0	35.5	22.2	8G8MP
-8	12	1/2	3/4" - 14 NPTF	75.0	37.5	27.0	8G12MP
-10	16	5/8	1/2" - 14 NPTF	75.0	37.5	23.8	10G8MP
-10	16	5/8	3/4" - 14 NPTF	75.0	37.5	27.0	10G12MP
-12	20	3/4	1/2" - 14 NPTF	88.0	37.0	27.0	12G8MP
-12	20	3/4	3/4" - 14 NPTF	88.0	37.0	27.0	12G12MP
-12	20	3/4	1" - 11.5 NPTF	96.0	45.0	34.9	12G16MP
-16	25	1	3/4" - 14 NPTF	100.0	43.2	34.9	16G12MP
-16	25	1	1" - 11.5 NPTF	104.5	47.7	34.9	16G16MP
-20	32	1.1/4	1.1/4" - 11.5 NPTF	113.0	54.0	44.5	20G20MP

Warning: Use only in NPTF connections. Do not use in oil field (API) connections. Blow apart of an oil field connection can result in serious injuries.

Unless otherwise stated the coupling meets the pressure rating requirements of the respective international standard.



TABLE OF CONTENTS

ABOUT GATES

HYDRAULIC HOSE

HYDRAULIC HOSE COUPLINGS

ENGINEERING AND TECHNICAL DATA

NPTF MPLN

Male NPTF pipe (Long Nose).

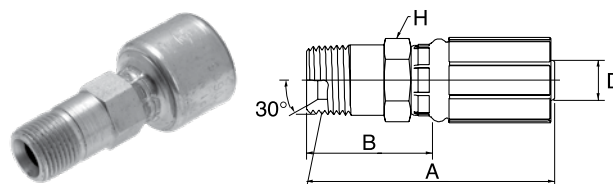

↻			🌀	↔			📏
D				A	B	H	REF.
-size	DN	"		mm	mm	mm	G
-4	6	1/4	1/4" - 18 NPTF	65.0	39.0	14.3	4G4MPLN
-4	6	1/4	3/8" - 18 NPTF	65.0	39.0	17.5	4G6MPLN
-6	10	3/8	1/4" - 18 NPTF	69.0	41.1	15.9	6G4MPLN
-6	10	3/5	3/8" - 18 NPTF	69.0	41.1	17.5	6G6MPLN

NPTF FP

Female NPTF pipe.

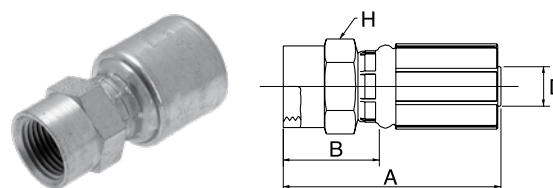

↻			🌀	↔			📏
D				A	B	H	REF.
-size	DN	"		mm	mm	mm	G
-4	6	1/4	1/8" - 27 NPTF	44.3	18.3	14.3	4G2FP
-4	6	1/4	1/4" - 18 NPTF	50.5	24.5	17.5	4G4FP
-4	6	1/4	3/8" - 18 NPTF	50.5	24.5	20.6	4G6FP
-6	10	3/8	1/4" - 18 NPTF	51.0	23.1	17.5	6G4FP
-6	10	3/8	3/8" - 18 NPTF	52.5	24.6	20.6	6G6FP
-6	10	3/8	1/2" - 14 NPTF	57.1	29.2	25.4	6G8FP
-8	12	1/2	3/8" - 18 NPTF	62.5	25.0	20.6	8G6FP
-8	12	1/2	1/2" - 14 NPTF	67.0	29.5	25.4	8G8FP
-12	20	3/4	3/4" - 14 NPTF	82.0	31.0	31.8	12G12FP

Unless otherwise stated the coupling meets the pressure rating requirements of the respective international standard.

NPTF MPX

Male NPTF pipe swivel.

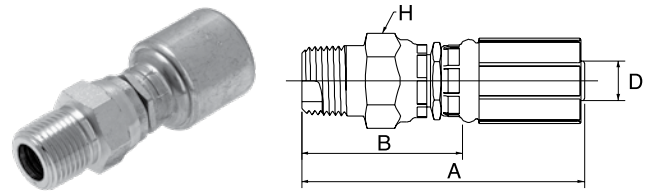

D				A	B	H	REF.
-size	DN	"		mm	mm	mm	G
-4	6	1/4	1/4" - 18 NPTF	66.3	40.2	17.5	4G4MPX
-4	6	1/4	3/8" - 18 NPTF	69.5	43.5	22.2	4G6MPX
-4	6	1/4	1/2" - 14 NPTF	75.4	49.4	25.4	4G8MPX
-6	10	3/8	1/4" - 18 NPTF	72.8	44.9	22.2	6G4MPX
-6	10	3/8	3/8" - 18 NPTF	71.5	43.6	22.2	6G6MPX
-6	10	3/8	1/2" - 14 NPTF	77.4	49.5	25.4	6G8MPX
-8	12	1/2	3/8" - 18 NPTF	82.0	44.6	22.2	8G6MPX
-8	12	1/2	1/2" - 14 NPTF	86.9	49.4	25.4	8G8MPX
-10	16	5/8	3/4" - 14 NPTF	88.5	51.1	33.3	10G12MPX
-12	20	3/4	1/2" - 14 NPTF	100.9	49.9	27.0	12G8MPX
-12	20	3/4	3/4" - 14 NPTF	102.0	51.0	33.3	12G12MPX
-16	25	1	1" - 11.5 NPTF	120.2	63.4	41.3	16G16MPX

Note: Internal seal rings are NBR material. Coupling cannot be swivelled under pressure. Not to be used as a live swivel.

NPTF MPX90

Male NPTF pipe swivel.

90° block elbow.

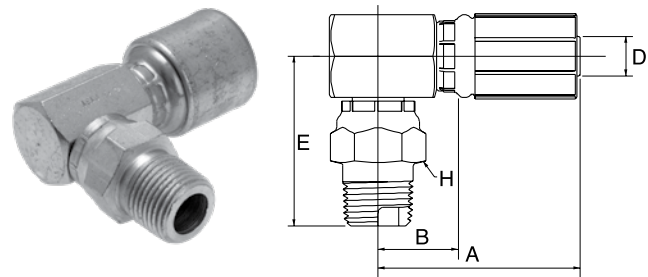

D				A	B	E	H	REF.
-size	DN	"		mm	mm	mm	mm	G
-4	6	1/4	1/4" - 18 NPTF	44.5	18.4	41.3	17.5	4G4MPX90
-4	6	1/4	3/8" - 18 NPTF	46.3	20.2	44.0	22.2	4G6MPX90
-6	10	3/8	1/4" - 18 NPTF	49.7	21.7	42.1	17.5	6G4MPX90
-6	10	3/8	3/8" - 18 NPTF	49.7	21.7	44.8	22.2	6G6MPX90
-6	10	3/8	1/2" - 14 NPTF	49.7	21.7	49.1	25.4	6G8MPX90
-8	12	1/2	3/8" - 18 NPTF	64.7	27.2	48.0	22.2	8G6MPX90
-8	12	1/2	1/2" - 14 NPTF	64.7	27.2	52.3	25.4	8G8MPX90
-12	20	3/4	3/4" - 14 NPTF	80.7	29.7	58.4	34.9	12G12MPX90

Note: Not to be used as a live swivel.

Unless otherwise stated the coupling meets the pressure rating requirements of the respective international standard.



UNF MB

Male SAE 'O' ring boss. SAE J1926/3.
ISO 11926/3 light duty (L series).

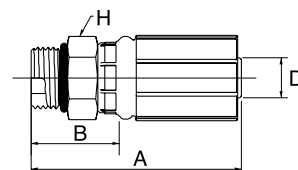

-size	D		REF.
	DN	"	
-4	6	1/4	4G4MB
-4	6	1/4	4G5MB
-4	6	1/4	4G6MB
-6	10	3/8	6G6MB
-6	10	3/8	6G8MB
-6	10	3/8	6G10MB
-6	10	3/8	6G12MB
-8	12	1/2	8G8MB
-8	12	1/2	8G10MB
-8	12	1/2	8G12MB
-10	16	5/8	10G8MB
-10	16	5/8	10G10MB
-10	16	5/8	10G12MB
-12	20	3/4	12G12MB
-12	20	3/4	12G14MB
-12	20	3/4	12G16MB
-16	25	1	16G14MB
-16	25	1	16G16MB
-20	32	1.1/4	20G20MB

Unless otherwise stated the coupling meets the pressure rating requirements of the respective international standard.

TABLE OF CONTENTS

ABOUT GATES

HYDRAULIC HOSE

HYDRAULIC HOSE COUPLINGS

ENGINEERING AND TECHNICAL DATA

UNF MBX

Male SAE 'O' ring boss swivel.
SAE J1926/3. ISO 11926/3 light duty (L series).

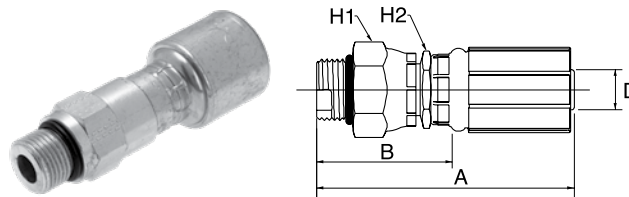

↻			🌀	↔				📏
D				A	B	H1	H2	REF.
-size	DN	"		mm	mm	mm	mm	G
-4	6	1/4	9/16" - 18 UNF	81.5	55.5	19.0		4G6MBX
-6	10	3/8	9/16" - 18 UNF	84.5	56.6	22.0		6G6MBX
-6	10	3/8	3/4" - 16 UNF	84.5	56.6	24.0		6G8MBX
-6	10	3/8	7/8" - 14 UNF	81.5	53.6	27.0		6G10MBX
-8	12	1/2	3/4" - 16 UNF	96.0	58.5	24.0		8G8MBX
-8	12	1/2	7/8" - 14 UNF	97.5	60.0	27.0		8G10MBX
-12	20	3/4	1.1/16" - 12 UN	115.5	64.5	32.0		12G12MBX

Note: Not to be used as a live swivel.

UNF MBX45BL

Male SAE 'O' ring boss swivel.
SAE J1926/3. ISO 11926/3 light duty (L series).
45° block elbow.

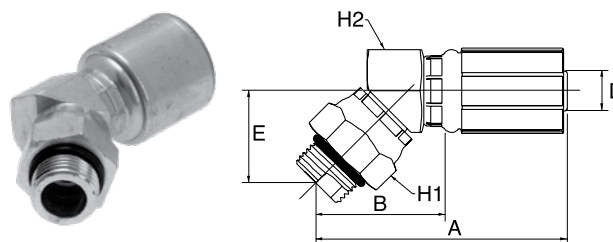

↻			🌀	↔					📏
D				A	B	E	H1	H2	REF.
-size	DN	"		mm	mm	mm	mm	mm	G
-6	10	3/8	9/16" - 18 UNF	79.0	51.0	27.8	22.2	19.1	6G6MBX45BL
-6	10	3/8	3/4" - 16 UNF	78.1	50.2	26.9	25.4	19.1	6G8MBX45BL
-8	12	1/2	3/4" - 16 UNF	77.2	39.7	28.4	25.4	25.4	8G8MBX45BL

Note: Internal seal rings are NBR material. Coupling cannot be swivelled under pressure. Not to be used as a live swivel.

Unless otherwise stated the coupling meets the pressure rating requirements of the respective international standard.

UNF MBX90

Male SAE 'O' ring boss swivel.
 SAE J1926/3. ISO 11926/3 light duty (L series).
 90° swept elbow.

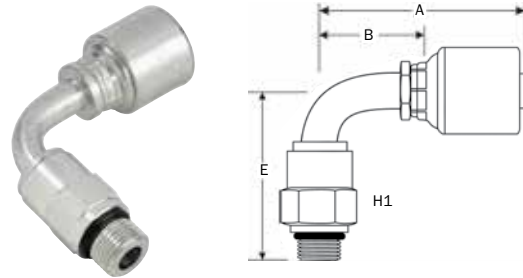

↻			🌀	↔				📏
D				A	B	E	H1	REF.
-size	DN	"		mm	mm	mm	mm	G
-6	10	3/8	9/16" - 18 UNF	62.8	34.8	63.1	22.0	6G6MBX90
-8	12	1/2	3/4" - 16 UNF	80.3	42.9	70.1	24.0	8G8MBX90
-8	12	1/2	7/8" - 14 UNF	80.3	42.9	71.6	27.0	8G10MBX90
-8	12	1/2	1.1/16" - 12 UN	80.3	42.9	73.6	32.0	8G12MBX90
-12	20	3/4	1.1/16" - 12 UN	110.1	59.1	86.8	32.0	12G12MBX90

Note: Internal seal rings are NBR material. Coupling cannot be swivelled under pressure. Not to be used as a live swivel.

UNF MBX90BL

Male SAE 'O' ring boss swivel.
 SAE J1926/3. ISO 11926/3 light duty (L series).
 90° block elbow.

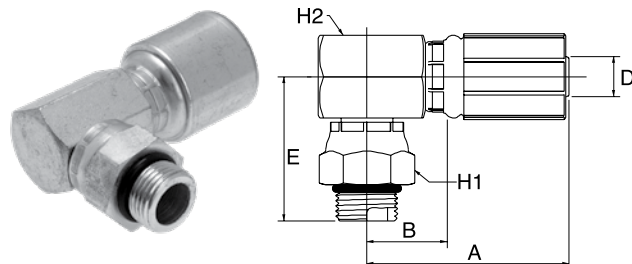

↻			🌀	↔					📏
D				A	B	E	H1	H2	REF.
-size	DN	"		mm	mm	mm	mm	mm	G
-4	6	1/4	9/16" - 18 UNF	46.3	20.2	41.7	22.2	17.5	4G6MBX90BL
-6	10	3/8	3/4" - 16 UNF	49.7	21.8	41.3	25.4	19.1	6G8MBX90BL
-6	10	3/8	7/8" - 14 UNF	49.7	21.8	42.8	25.4	19.1	6G10MBX90BL
-8	12	1/2	3/4" - 16 UNF	77.1	27.2	44.4	25.4	25.4	8G8MBX90BL
-8	12	1/2	7/8" - 14 UNF	77.1	27.2	39.6	25.4	25.4	8G10MBX90BL
-10	16	5/8	7/8" - 14 UNF	60.9	23.4	39.6	25.4	25.4	10G10MBX90BL
-12	20	3/4	1.1/16" - 12 UN	96.0	29.7	60.6	33.3	34.9	12G12MBX90BL

Note: Internal seal rings are NBR material. Coupling cannot be swivelled under pressure. Not to be used as a live swivel.

Unless otherwise stated the coupling meets the pressure rating requirements of the respective international standard.

TABLE OF CONTENTS

ABOUT GATES

HYDRAULIC HOSE

HYDRAULIC HOSE COUPLINGS

ENGINEERING AND TECHNICAL DATA

FG FFGX

Female French Gaz swivel. 24° cone.

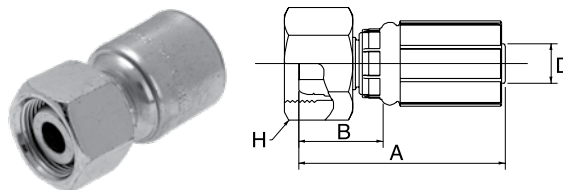

D				A	B	H	REF.
-size	DN	"		mm	mm	mm	G
-4	6	1/4	M20 x 1.5	47.0	21.0	24.0	4G13FFGX
-5	8	5/16	M20 x 1.5	51.6	23.6	24.0	5G13FFGX
-6	10	3/8	M20 x 1.5	49.0	21.1	24.0	6G13FFGX
-8	12	1/2	M24 x 1.5	61.0	23.5	30.0	8G17FFGX
-10	16	5/8	M30 x 1.5	59.5	22.0	36.0	10G21FFGX
-12	20	3/4	M36 x 1.5	74.0	23.0	46.0	12G27FFGX
-16	25	1	M45 x 1.5	83.0	26.2	55.0	16G34FFGX
-20	32	1.1/4	M52 x 1.5	85.5	26.5	60.0	20G42FFGX

FG FFGX45

Female French Gaz flare swivel.
24° cone. 45° swept elbow.

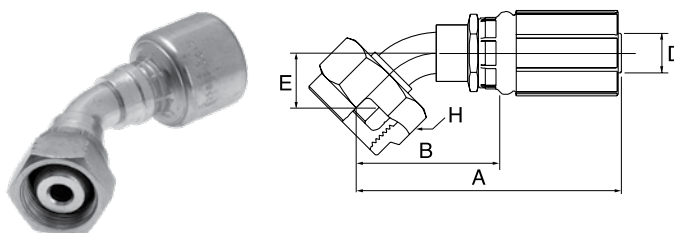

D				A	B	E	H	REF.
-size	DN	"		mm	mm	mm	mm	G
-6	10	3/8	M20 x 1.5	78.1	50.2	25.2	24.0	6G13FFGX45

Unless otherwise stated the coupling meets the pressure rating requirements of the respective international standard.

FG FFGX90

Female French Gaz swivel.
24° cone. 90° swept elbow.

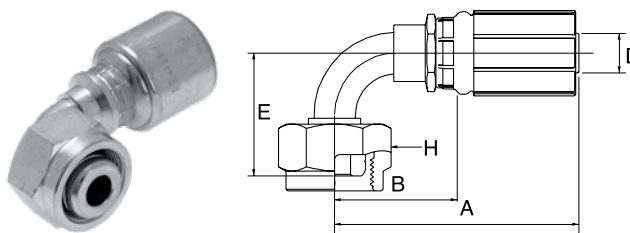

↻			🌀	↔				📏
D				A	B	E	H	REF.
-size	DN	"		mm	mm	mm	mm	G
-5	8	5/16	M20 x 1.5	64.1	36.1	46.7	24.0	5G13FFGX90
-6	10	3/8	M20 x 1.5	64.1	36.2	46.7	24.0	6G13FFGX90
-8	12	1/2	M24 x 1.5	73.1	35.7	37.8	30.0	8G17FFGX90
-10	16	5/8	M30 x 1.5	79.0	41.6	45.0	36.0	10G21FFGX90
-12	20	3/4	M30 x 1.5	109.6	58.6	71.2	46.0	12G27FFGX90

FG MFG

Male French Gaz parallel. 24° inverted cone.

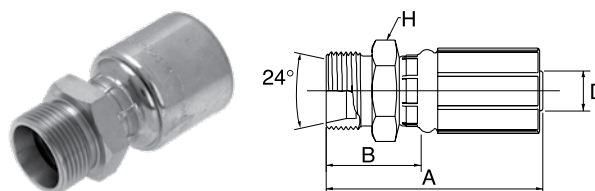

↻			🌀	↔			📏
D				A	B	H	REF.
-size	DN	"		mm	mm	mm	G
-5	8	5/16	M20 x 1.5	54.6	26.6	24.0	5G13MFG
-6	10	3/8	M20 x 1.5	55.5	27.5	24.0	6G13MFG
-8	12	1/2	M24 x 1.5	67.6	30.1	27.0	8G17MFG
-10	16	5/8	M30 x 1.5	70.0	32.5	32.0	10G21MFG
-12	20	3/4	M36 x 1.5	84.0	33.0	41.0	12G27MFG
-16	25	1	M45 x 1.5	94.0	37.2	46.0	16G34MFG
-20	32	1.1/4	M52 x 1.5	100.0	41.0	55.0	20G42MFG

Unless otherwise stated the coupling meets the pressure rating requirements of the respective international standard.

HLE

Hose length extender

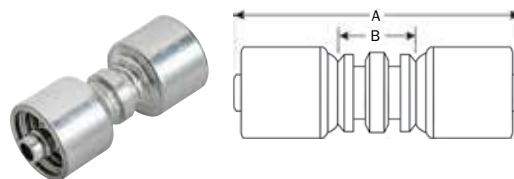

D			A	B	REF.
-size	DN	"	mm	mm	G
-4	6	1/4	69.5	17.4	4G4HLE
-5	8	5/16	74.0	18.0	5G5HLE
-6	10	3/8	74.0	18.1	6G6HLE

PL

Male Press-Lok stem.

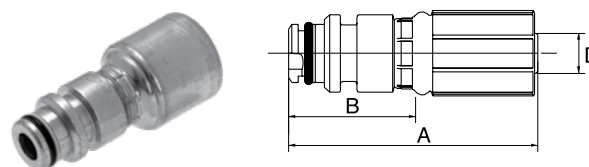

D			A	B	REF.
-size	DN	"	mm	mm	G
-4	6	1/4	65.0	39.0	4G4PL
-6	10	3/8	67.0	39.1	6G6PL
-8	12	1/2	76.5	39.0	8G8PL
-12	20	3/4	90.5	39.5	12G12PL
-16	25	1	105.0	48.2	16G16PL
-20	32	1.1/4	108.0	49.0	20G20PL

Note: 4G4PL: 40 MPa dynamic working pressure; 6G6PL: 30 MPa dynamic working pressure; 8G8PL: 27.5 MPa dynamic working pressure; 12G12PL: 21.5 MPa dynamic working pressure; 16G16PL: 16.5 MPa dynamic working pressure; 20G20PL: 12.5 MPa dynamic working pressure.

Unless otherwise stated the coupling meets the pressure rating requirements of the respective international standard.

AV

Male agricultural valve.

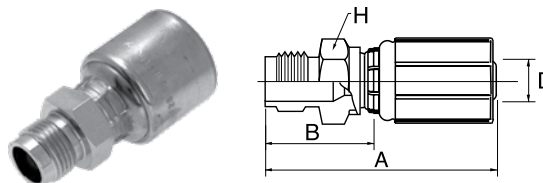

↔			🌀	↔			🔧
D				A	B	H	REF.
-size	DN	"		mm	mm	mm	G
-5	8	5/16	M18 x 1.5	59.5	31.5	22.0	5G18AV
-6	10	3/8	M18 x 1.5	59.5	31.6	22.0	6G18AV
-8	12	1/2	M18 x 1.5	69.6	32.1	22.0	8G18AV

PRESSUREWASH FPWXL

Female PressureWash swivel.

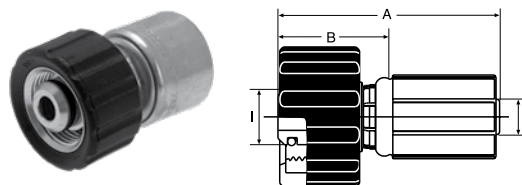

↔			🌀	↔			🔧
D				A	B	I	REF.
-size	DN	"		mm	mm	mm	G
-4	6	1/4	M22 x 1.5	58.2	32.2	13.9	4G15FPWXL
-5	8	5/16	M22 x 1.5	59.0	31.0	13.9	5G15FPWXL
-6	10	3/8	M22 x 1.5	60.0	32.1	13.9	6G15FPWXL

Unless otherwise stated the coupling meets the pressure rating requirements of the respective international standard.

PRESSUREWASH PWSP

Male PressureWash standpipe with 'O' ring.

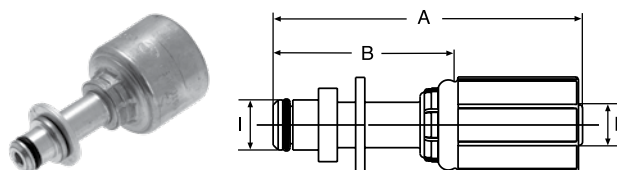

↔			↔			
D			A	B	I	REF.
-size	DN	"	mm	mm	mm	G
-4	6	1/4	60.5	34.5	9.9	4G10PWSP
-4	6	1/4	64.5	38.6	10.9	4G11PWSP
-5	8	5/16	64.5	36.5	9.9	5G10PWSP
-5	8	5/16	67.5	39.5	10.9	5G11PWSP
-6	10	3/8	64.5	36.6	9.9	6G10PWSP
-6	10	3/8	67.5	39.6	10.9	6G11PWSP

QUICK-LOK HIGH MQLH

Male Quick-Lok™ High.

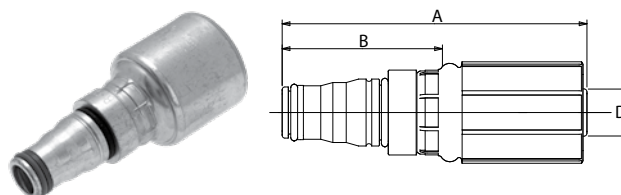

↔			QLH	↔		
D				A	B	REF.
-size	DN	"		mm	mm	G
-4	6	1/4	4MQLH	67.0	41.0	4G4MQLH
-6	10	3/8	6MQLH	69.0	41.1	6G6MQLH
-8	12	1/2	8MQLH	79.0	41.5	8G8MQLH
-10	16	5/8	10MQLH	79.0	41.5	10G10MQLH
-12	20	3/4	12MQLH	93.0	42.0	12G12MQLH
-16	25	1	16MQLH	101.0	44.2	16G16MQLH

-4 to -8 size are 35.0 MPa (5000 psi); -10 & -12 size are 28.0 MPa (4000 psi); -16 size is 21.0 MPa (3000 psi). / Note: not to be used as a live swivel.

Unless otherwise stated the coupling meets the pressure rating requirements of the respective international standard.

QUICK-LOK HIGH MQLH45

Male Quick-Lok™ High.
45° swept elbow.

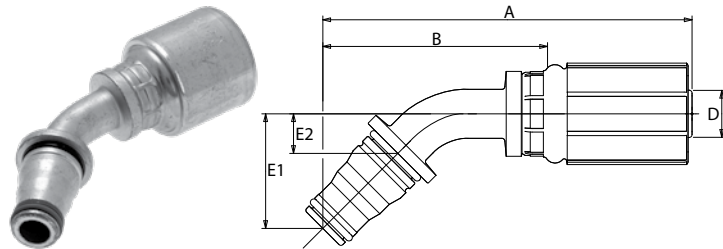

↻			QLH	↔				↻
D				A	B	E1	E2	REF.
-size	DN	"		mm	mm	mm	mm	G
-4	6	1/4	4MQLH45	75.1	49.1	26.9	7.5	4G4MQLH45
-6	10	3/8	6MQLH45	81.6	53.7	27.7	8.3	6G6MQLH45
-8	12	1/2	8MQLH45	95.7	58.2	29.7	10.3	8G8MQLH45
-10	16	5/8	10MQLH45	104.6	67.1	32.1	12.7	10G10MQLH45
-12	20	3/4	12MQLH45	124.0	73.0	33.6	14.2	12G12MQLH45
-16	25	1	16MQLH45	139.5	82.7	36.1	16.7	16G16MQLH45

-4 to -8 size are 35.0 MPa (5000 psi); -10 & -12 size are 28.0 MPa (4000 psi); -16 size is 21.0 MPa (3000 psi). / Note: not to be used as a live swivel.

QUICK-LOK HIGH MQLH90

Male Quick-Lok™ High.
90° swept elbow.

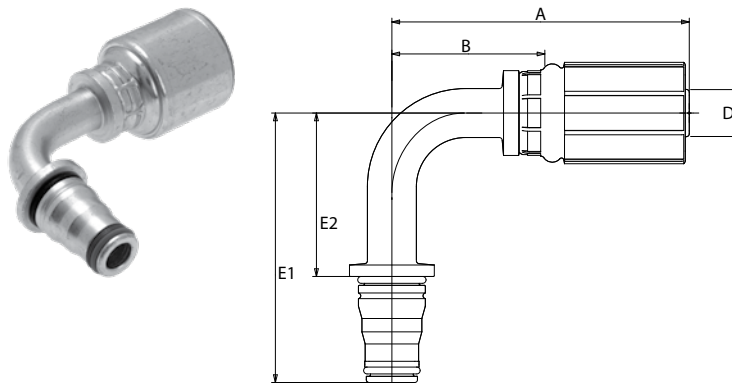

↻			QLH	↔				↻
D				A	B	E1	E2	REF.
-size	DN	"		mm	mm	mm	mm	G
-4	6	1/4	4MQLH90S	55.6	29.6	45.5	18.0	4G4MQLH90S
-6	10	3/8	6MQLH90S	62.8	34.8	47.6	20.1	6G6MQLH90S
-8	12	1/2	8MQLH90S	80.3	42.9	53.1	25.6	8G8MQLH90S
-10	16	5/8	10MQLH90S	90.1	52.6	60.3	32.8	10G10MQLH90S
-12	20	3/4	12MQLH90S	110.1	59.1	64.3	36.8	12G12MQLH90S
-16	25	1	16MQLH90S	139.1	82.3	71.3	43.8	16G16MQLH90S

-4 to -8 size are 35.0 MPa (5000 psi); -10 & -12 size are 28.0 MPa (4000 psi); -16 size is 21.0 MPa (3000 psi). / Note: not to be used as a live swivel.

Unless otherwise stated the coupling meets the pressure rating requirements of the respective international standard.

QUICK-LOK HIGH FQLH

Female Quick-Lok™ High.

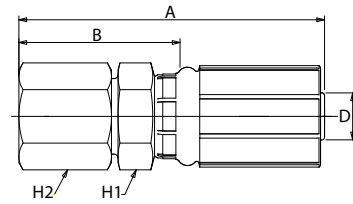

			QLH					
D				A	B	H1	H2	REF.
-size	DN	"		mm	mm	mm	mm	G
-4	6	1/4	4FQLH	67.7	41.7	19.1	19.0	4G4FQLH
-6	10	3/8	6FQLH	69.7	41.8	22.0	22.0	6G6FQLH
-8	12	1/2	8FQLH	79.2	41.8	24.0	24.0	8G8FQLH
-10	16	5/8	10FQLH	80.3	42.8	27.0	30.0	10G10FQLH
-12	20	3/4	12FQLH	89.7	38.7	32.0	36.0	12G12FQLH
-16	25	1	16FQLH	101.7	44.9	41.0	41.0	16G16FQLH

-4 to -8 size are 35.0 MPa (5000 psi); -10 & -12 size are 28.0 MPa (4000 psi); -16 size is 21.0 MPa (3000 psi). / Note: not to be used as a live swivel.

Unless otherwise stated the coupling meets the pressure rating requirements of the respective international standard.



**MEGASYS™ COUPLINGS
FOR PILOT HYDRAULIC HOSE**



NO-SKIVE FERRULES

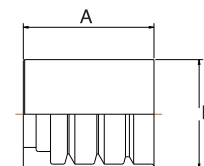

D			A	B	REF.
-size	DN	"	mm	mm	P1T
-3	5	3/16	21.0	15.7	3MP1F-1
-4	6	1/4	20.5	17.7	4MP1F-1
-5	8	5/16	22.9	19.1	5MP1F-1
-6	10	3/8	23.5	23.3	6MP1F-1

BSP FBSPORX

Female BSP 'O' ring swivel. 60° cone.

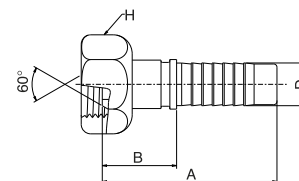

D				A	B	H	REF.
-size	DN	"		mm	mm	mm	P1T
-3	5	3/16	G 1/4" - 19 BSP	35.3	15.3	19.0	P1T0304FBSPORX
-4	6	1/4	G 1/4" - 19 BSP	32.5	14.4	19.0	P1T0404FBSPORX
-4	6	1/4	G 3/8" - 19 BSP	33.3	15.2	22.0	P1T0406FBSPORX
-6	10	3/8	G 3/8" - 19 BSP	36.5	10.2	22.0	P1T0606FBSPORX

BSP FBSPORX45

Female BSP 'O' ring swivel. 60° cone.
45° swept elbow.

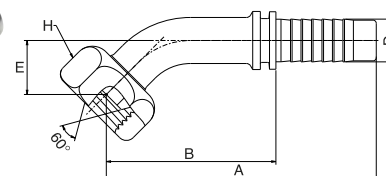

D				A	B	E	H	REF.
-size	DN	"		mm	mm	mm	mm	P1T
-4	6	1/4	1/4" - 19 BSP	54.9	36.8	11.3	19.0	P1T0404FBSPORX45
-6	10	3/8	3/8" - 19 BSP	61.1	39.8	15.4	22.0	P1T0606FBSPORX45

Unless otherwise stated the coupling meets the pressure rating requirements of the respective international standard.

BSP FBSPORX90

Female BSP 'O' ring swivel. 60° cone.
90° swept elbow.

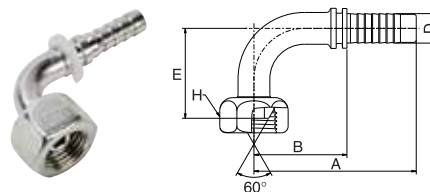

D				A B E H				REF.
-size	DN	"		mm	mm	mm	mm	
-4	6	1/4	1/4" - 19 BSP	41.6	23.5	23.0	19.0	P1T0404FBSPORX90
-6	10	3/8	3/8" - 19 BSP	56.0	34.7	32.0	22.0	P1T0606FBSPORX90

JIC 37° FJX

Female JIC swivel. 37° inverted cone.

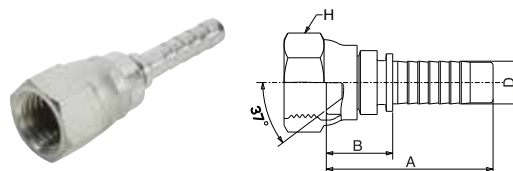

D				A B H			REF.
-size	DN	"		mm	mm	mm	
-3	5	3/16	7/16" - 20 UNF	36.0	16.0	14.0	P1T0304FJX

JIC 37° MJ

Male JIC parallel. 37° cone.

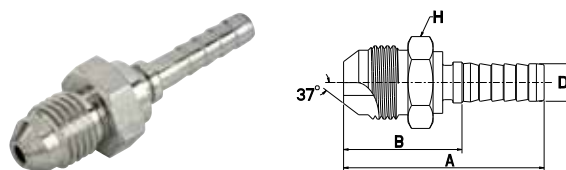

D				A B		REF.
-size	DN	"		mm	mm	
-3	5	3/16	7/16" - 20 UNF	46.0	26.0	P1T0304MJ

Unless otherwise stated the coupling meets the pressure rating requirements of the respective international standard.

SAE FFORX

Female SAE flat face 'O' ring swivel.

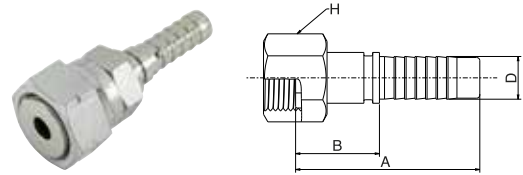

D				A	B	H1	H2	REF.
-size	DN	"		mm	mm	mm	mm	P1T
-5	8	5/16	11/16" - 16 UN	53.5	32.2	22.0	17.0	P1T0506FFORX

SAE FFORX45

Female SAE flat face 'O' ring swivel.
45° swept elbow.

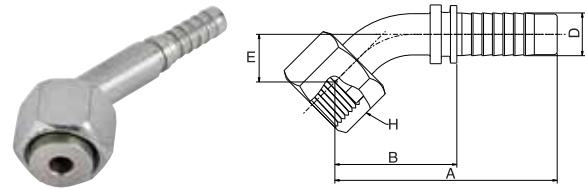

D				A	B	E	H	REF.
-size	DN	"		mm	mm	mm	mm	P1T
-5	8	5/16	11/16" - 16 UN	69.3	48.0	13.3	22.0	P1T0506FFORX45

SAE FFORX90

Female SAE flat face 'O' ring swivel.
90° swept elbow.

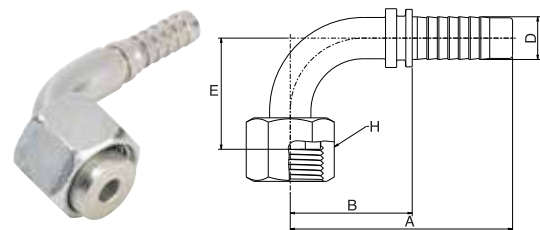

D				A	B	E	H	REF.
-size	DN	"		mm	mm	mm	mm	P1T
-5	8	5/16	11/16" - 16 UN	56.0	34.7	29.0	22.0	P1T0506FFORX90

Unless otherwise stated the coupling meets the pressure rating requirements of the respective international standard.

DIN 24° FDLORX

Female DIN 'O' ring swivel. 24° cone.
Light series.

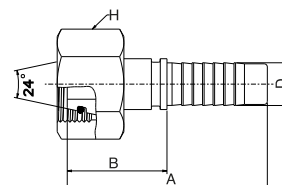

D			M12 x 1.5	A B H			REF. P1T
-size	DN	"		mm	mm	mm	
-3	5	3/16	M12 x 1.5	47.5	27.5	14.0	P1T0306FDLORX
-4	6	1/4	M14 x 1.5	45.6	27.5	17.0	P1T0408FDLORX

DIN 24° FDLORX45

Female DIN 'O' ring swivel. 24° cone.
Light series. 45° swept elbow.

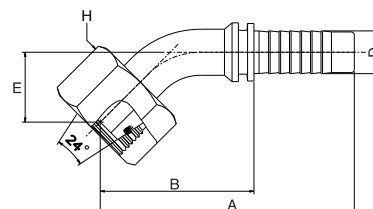

D			M14 x 1.5	A B E H				REF. P1T
-size	DN	"		mm	mm	mm	mm	
-4	6	1/4	M14 x 1.5	59.4	41.3	16.9	17.0	P1T0408FDLORX45

DIN 24° FDLORX90

Female DIN 'O' ring swivel. 24° cone.
Light series. 90° swept elbow.

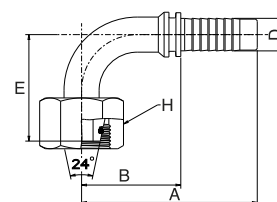

D			M14 x 1.5	A B E H				REF. P1T
-size	DN	"		mm	mm	mm	mm	
-4	6	1/4	M14 x 1.5	53.6	35.5	35.0	15.0	P1T0408FDLORX90

Unless otherwise stated the coupling meets the pressure rating requirements of the respective international standard.

TABLE OF CONTENTS

ABOUT GATES

HYDRAULIC HOSE

HYDRAULIC HOSE COUPLINGS

ENGINEERING AND TECHNICAL DATA

DIN 24° MDL

Male DIN parallel. 24° inverted cone.
Light series.

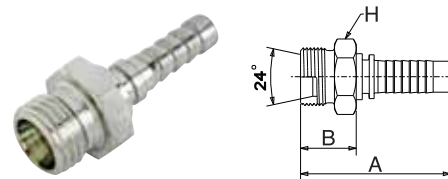

D				A	B	H	REF.
-size	DN	"		mm	mm	mm	P1T
-3	5	3/16	M12 x 1.5	40.9	20.8	14.0	P1T0306MDL
-4	6	1/4	M14 x 1.5	40.6	22.5	17.0	P1T0408MDL

METRIC DBJ

Metric banjo.

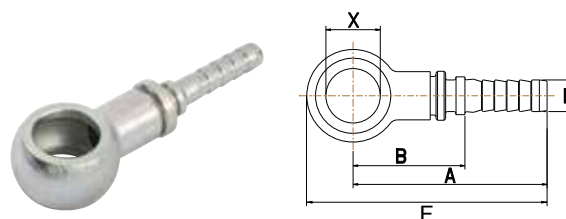

D				A	B	F	X	REF.
-size	DN	"		mm	mm	mm	mm	P1T
-3	5	3/16	M10	44.0	24.0	52.5	10.1	P1T0310DBJ
-3	5	3/16	M12	46.0	26.0	56.0	12.1	P1T0312DBJ

Details on banjo bolts see Megacrimp section page 253.

QUIK-LOK DIRECT MQLD

Male Quick-Lok™ Direct.

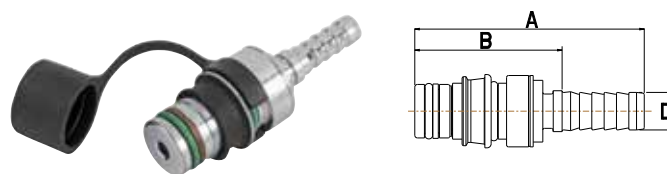

D			A	B	REF.
-size	DN	"	mm	mm	P1T
-4	6	1/4	56.0	37.9	P1T04T1MQLD
-6	10	3/8	59.5	38.2	P1T06T1MQLD

QLD is pressure rated up to 28.0 MPa (4000 psi).

Unless otherwise stated the coupling meets the pressure rating requirements of the respective international standard.

QUIK-LOK DIRECT MQLD45

Male Quick-Lok™ Direct.
45° swept elbow.

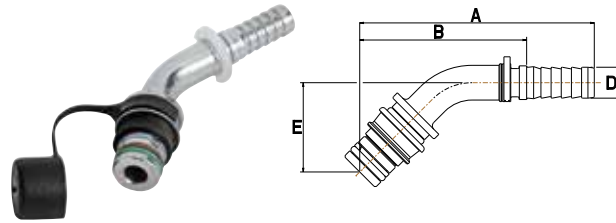

D			A	B	E	REF.
-size	DN	"	mm	mm	mm	P1T
-4	6	1/4	64.6	46.5	26.5	P1T04T1MQLD45
-6	10	3/8	73.9	52.6	27.1	P1T06T1MQLD45

QLD is pressure rated up to 28.0 MPa (4000 psi).

QUIK-LOK DIRECT MQLD90

Male Quick-Lok™ Direct.
90° swept elbow.

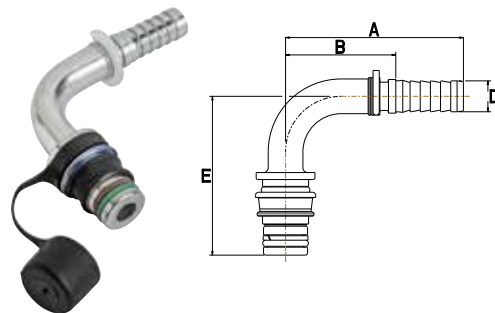

D			A	B	E	REF.
-size	DN	"	mm	mm	mm	P1T
-4	6	1/4	45.1	27.0	44.5	P1T04T1MQLD90S-045
-6	10	3/8	56.0	34.7	50.0	P1T06T1MQLD90S-050

QLD is pressure rated up to 28.0 MPa (4000 psi).

QLD RELEASE TOOL

Release tool for QLD couplings.



REF.	MATERIAL
P1T	STEEL
T1 QLD RELEASE TOOL	

Unless otherwise stated the coupling meets the pressure rating requirements of the respective international standard.

QUICK-LOK LOW MQLL

Male Quick-Lok™ Low.

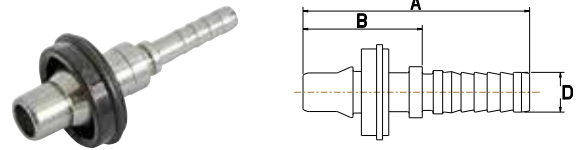

↔			↔		↔
D			A	B	REF.
-size	DN	"	mm	mm	P1T
-3	5	3/16	50.6	30.6	3P1T6MQLL
-4	6	1/4	53.0	34.9	4P1T6MQLL

QLL is pressure rated up to 3.4 MPa (500 psi). Only approved for non-impulse applications.

QUICK-LOK LOW MQLL45

Male Quick-Lok™ Low.
45° swept elbow.

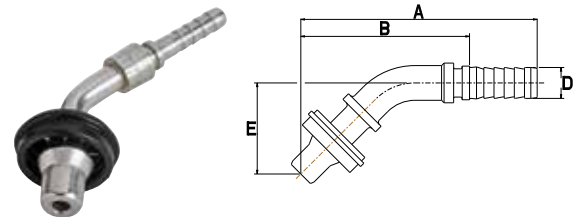

↔			↔			↔
D			A	B	E	REF.
-size	DN	"	mm	mm	mm	P1T
-3	5	3/16	63.4	43.4	21.0	3P1T6MQLL45-021
-4	6	1/4	55.5	37.4	18.0	4P1T6MQLL45-018

QLL is pressure rated up to 3.4 MPa (500 psi). Only approved for non-impulse applications.

QUICK-LOK LOW MQLL90

Male Quick-Lok™ Low.
90° swept elbow.

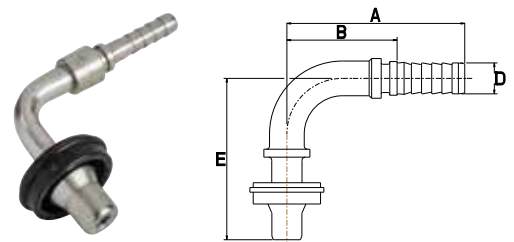

↔			↔			↔
D			A	B	E	REF.
-size	DN	"	mm	mm	mm	P1T
-3	5	3/16	48.0	28.0	37.0	3P1T6MQLL90S-037
-4	6	1/4	47.3	29.2	35.3	4P1T6MQLL90S

QLL is pressure rated up to 3.4 MPa (500 psi). Only approved for non-impulse applications.

Unless otherwise stated the coupling meets the pressure rating requirements of the respective international standard.



QLL RELEASE TOOL

Release tool for QLL couplings.



	
REF.	MATERIAL
P1T	
QLL RELEASE TOOL - Steel	STEEL
QLL RELEASE TOOL - Polypropylene	Polypropylene

TABLE OF CONTENTS

ABOUT GATES

HYDRAULIC HOSE

HYDRAULIC HOSE COUPLINGS

ENGINEERING AND TECHNICAL DATA

Unless otherwise stated the coupling meets the pressure rating requirements of the respective international standard.



PRO™ SERIES

NO-SKIVE FERRULES FOR PRO1T, CR2, CR1 & IA3K

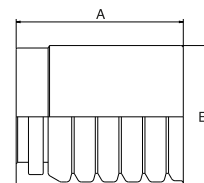

D			A	B	REF.
-size	DN	"	mm	mm	EX
-4	6	1/4	28.0	23.0	4EX1F-1
-5	8	5/16	29.0	24.0	5EX1F-1
-6	10	3/8	31.5	26.0	6EX1F-1
-8	12	1/2	33.5	29.0	8EX1F-1
-10	16	5/8	35.5	33.0	10EX1F-1
-12	20	3/4	41.0	37.0	12EX1F-1
-16	25	1	50.5	46.0	16EX1F-1

NO-SKIVE FERRULES FOR PROV

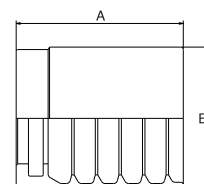

D			A	B	REF.
-size	DN	"	mm	mm	EX
-4	6	1/4	28.0	23.0	4EX1F-1
-5	8	5/16	29.0	24.0	5EX1F-1
-6	10	3/8	29.0	26.0	6EXVF-1
-8	12	1/2	33.5	29.0	8EXVF-1
-10	16	5/8	32.5	33.0	10EXVF-1
-12	20	3/4	41.0	37.0	12EX1F-1
-16	25	1	47.0	47.0	16EXVF-1

Unless otherwise stated the coupling meets the pressure rating requirements of the respective international standard.

TABLE OF CONTENTS

ABOUT GATES

HYDRAULIC HOSE

HYDRAULIC HOSE COUPLINGS

ENGINEERING AND TECHNICAL DATA

BSP FBSPPX

Female BSP swivel. 60° cone.

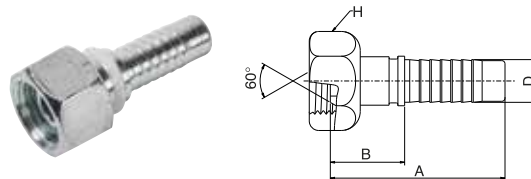

D				A	B	H	REF.
-size	DN	"		mm	mm	mm	EX
-4	6	1/4	G 1/4" - 19 BSP	46.0	18.0	19.0	4EX4FBSPPX
-4	6	1/4	G 3/8" - 19 BSP	50.5	22.5	22.0	4EX6FBSPPX
-6	10	3/8	G 3/8" - 19 BSP	52.0	22.0	22.0	6EX6FBSPPX
-6	10	3/8	G 1/2" - 14 BSP	52.5	22.5	27.0	6EX8FBSPPX
-8	12	1/2	G 1/2" - 14 BSP	55.0	23.0	27.0	8EX8FBSPPX
-10	16	5/8	G 5/8" - 14 BSP	54.5	20.0	28.0	10EX10FBSPPX
-12	20	3/4	G 3/4" - 14 BSP	62.5	23.0	32.0	12EX12FBSPPX
-16	25	1	G 1" - 11 BSP	79.0	25.5	38.0	16EX16FBSPPX

BSP FBSPPX45

Female BSP swivel. 60° cone.
45° swept elbow.

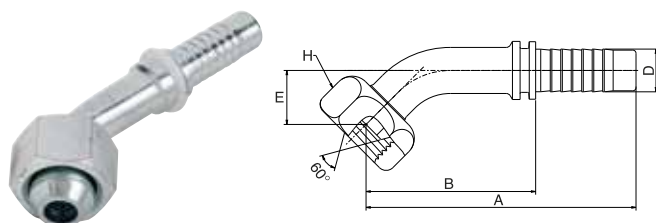

D				A	B	E	H	REF.
-size	DN	"		mm	mm	mm	mm	EX
-4	6	1/4	G 1/4" - 19 BSP	68.0	40.0	17.0	19.0	4EX4FBSPPX45
-4	6	1/4	G 3/8" - 19 BSP	71.0	43.0	20.0	22.0	4EX6FBSPPX45
-6	10	3/8	G 3/8" - 19 BSP	85.0	55.0	20.0	22.0	6EX6FBSPPX45
-6	10	3/8	G 1/2" - 14 BSP	88.0	58.0	23.0	27.0	6EX8FBSPPX45
-8	12	1/2	G 1/2" - 14 BSP	97.0	65.0	23.0	27.0	8EX8FBSPPX45
-10	16	5/8	G 5/8" - 14 BSP	98.5	64.0	25.0	28.0	10EX10FBSPPX45
-12	20	3/4	G 3/4" - 14 BSP	102.5	63.0	29.0	32.0	12EX12FBSPPX45
-16	25	1	G 1" - 11 BSP	143.5	90.0	41.0	38.0	16EX16FBSPPX45

Unless otherwise stated the coupling meets the pressure rating requirements of the respective international standard.

BSP FBSPPX90

Female BSP swivel. 60° cone.
90° swept elbow.

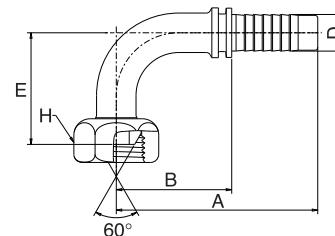

↔			🌀	↔				📏
D				A	B	E	H	REF.
-size	DN	"		mm	mm	mm	mm	EX
-4	6	1/4	G 1/4" - 19 BSP	52.0	24.0	25.0	19.0	4EX4FBSPPX90
-4	6	1/4	G 3/8" - 19 BSP	53.0	25.0	28.0	22.0	4EX6FBSPPX90
-6	10	3/8	G 3/8" - 19 BSP	60.5	30.5	32.0	22.0	6EX6FBSPPX90
-6	10	3/8	G 1/2" - 14 BSP	65.0	35.0	35.0	27.0	6EX8FBSPPX90
-8	12	1/2	G 1/2" - 14 BSP	73.0	41.0	41.0	27.0	8EX8FBSPPX90
-10	16	5/8	G 5/8" - 14 BSP	80.5	46.0	46.0	28.0	10EX10FBSPPX90
-12	20	3/4	G 3/4" - 14 BSP	90.5	51.0	54.5	32.0	12EX12FBSPPX90
-16	25	1	G 1" - 11 BSP	125.0	71.5	69.5	38.0	16EX16FBSPPX90

BSP MBSP

Male BSP parallel. 60° inverted cone.

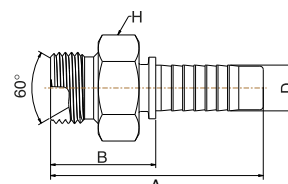

↔			🌀	↔			📏
D				A	B	H	REF.
-size	DN	"		mm	mm	mm	EX
-4	6	1/4	G 1/4" - 19 BSP	53.5	25.5	19.0	4EX4MBSP
-4	6	1/4	G 3/8" - 19 BSP	54.5	26.5	22.0	4EX6MBSP
-6	10	3/8	G 3/8" - 19 BSP	57.0	27.0	22.0	6EX6MBSP
-6	10	3/8	G 1/2" - 14 BSP	60.0	30.0	27.0	6EX8MBSP
-8	12	1/2	G 1/2" - 14 BSP	62.5	30.5	27.0	8EX8MBSP
-10	16	5/8	G 5/8" - 14 BSP	67.0	32.5	30.0	10EX10MBSP
-12	20	3/4	G 3/4" - 14 BSP	74.0	34.5	32.0	12EX12MBSP
-16	25	1	G 1" - 11 BSP	93.0	39.5	41.0	16EX16MBSP

Unless otherwise stated the coupling meets the pressure rating requirements of the respective international standard.

BSP BSPBJ

BSP banjo.

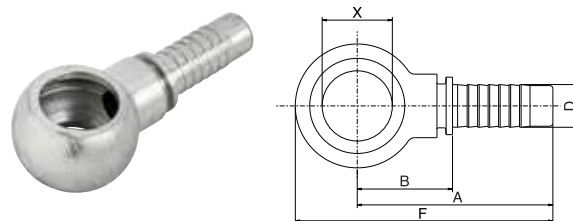

D				A	B	F	X	REF.
-size	DN	"		mm	mm	mm	mm	EX
-4	6	1/4	1/4" - BSP	49.5	21.5	61.5	13.2	4EX4BSPBJ
-6	10	3/8	3/8" - BSP	54.5	24.5	68.5	16.8	6EX6BSPBJ
-8	12	1/2	1/2" - BSP	61.5	29.5	79.0	21.0	8EX8BSPBJ

JIC 37° FJX

Female JIC swivel. 37° inverted cone.

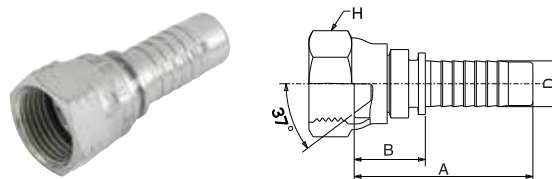

D				A	B	H	REF.
-size	DN	"		mm	mm	mm	EX
-4	6	1/4	7/16" - 20 UNF	41.5	13.5	15.0	4EX4FJX
-4	6	1/4	1/2" - 20 UNF	43.7	15.7	17.0	4EX5FJX
-4	6	1/4	9/16" - 18 UNF	43.7	15.7	19.0	4EX6FJX
-6	10	3/8	9/16" - 18 UNF	45.7	15.7	19.0	6EX6FJX
-6	10	3/8	3/4" - 16 UNF	48.5	18.5	24.0	6EX8FJX
-6	10	3/8	7/8" - 14 UNF	50.0	20.0	27.0	6EX10FJX
-8	12	1/2	3/4" - 16 UNF	51.0	19.0	24.0	8EX8FJX
-8	12	1/2	7/8" - 14 UNF	53.0	21.0	27.0	8EX10FJX
-8	12	1/2	1.1/16" - 12 UN	53.0	21.0	32.0	8EX12FJX
-10	16	5/8	7/8" - 14 UNF	55.5	21.0	27.0	10EX10FJX
-10	16	5/8	1.1/16" - 12 UN	55.5	21.0	32.0	10EX12FJX
-12	20	3/4	1.1/16" - 12 UN	61.1	21.6	32.0	12EX12FJX
-12	20	3/4	1.5/16" - 12 UN	62.7	23.2	38.0	12EX16FJX
-16	25	1	1.5/16" - 12 UN	77.7	24.2	38.0	16EX16FJX

Unless otherwise stated the coupling meets the pressure rating requirements of the respective international standard.

JIC 37° FJX45S

Female JIC swivel. 37° inverted cone.
45° swept elbow. Short drop.

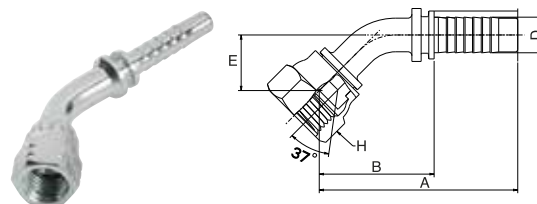

↻			🌀	↔				📏
D				A	B	E	H	REF.
-size	DN	"		mm	mm	mm	mm	EX
-4	6	1/4	7/16" - 20 UNF	66.0	38.0	15.0	15.0	4EX4FJX45S
-4	6	1/4	1/2" - 20 UNF	68.0	40.0	17.0	17.0	4EX5FJX45S
-4	6	1/4	9/16" - 18 UNF	68.0	40.0	17.0	19.0	4EX6FJX45S
-6	10	3/8	9/16" - 18 UNF	83.0	53.0	18.0	19.0	6EX6FJX45S
-6	10	3/8	3/4" - 16 UNF	84.0	54.0	19.0	24.0	6EX8FJX45S
-8	12	1/2	3/4" - 16 UNF	94.0	62.0	20.0	24.0	8EX8FJX45S
-8	12	1/2	7/8" - 14 UNF	95.0	63.0	21.0	27.0	8EX10FJX45S
-8	12	1/2	7/8" - 14 UNF	94.5	60.0	22.0	27.0	10EX10FJX45S
-10	16	5/8	1.1/16" - 12 UN	97.5	63.0	25.0	32.0	10EX12FJX45S
-12	20	3/4	1.1/16" - 12 UN	101.5	62.0	29.0	32.0	12EX12FJX45S
-16	25	1	1.5/16" - 12 UN	142.0	88.5	39.5	38.0	16EX16FJX45S

S: Short drop per ISO 12151-5.

JIC 37° FJX90S

Female JIC swivel. 37° inverted cone.
90° swept elbow. Short drop.

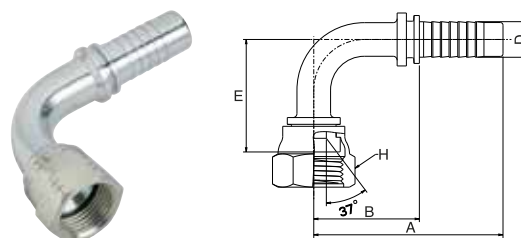

↻			🌀	↔				📏
D				A	B	E	H	REF.
-size	DN	"		mm	mm	mm	mm	EX
-4	6	1/4	7/16" - 20 UNF	49.0	21.0	26.5	15.0	4EX4FJX90S
-4	6	1/4	1/2" - 20 UNF	59.0	31.0	29.5	17.0	4EX5FJX90S
-4	6	1/4	9/16" - 18 UNF	49.5	21.5	28.0	19.0	4EX6FJX90S
-6	10	3/8	9/16" - 18 UNF	60.5	30.5	33.5	19.0	6EX6FJX90S
-6	10	3/8	3/4" - 16 UNF	62.0	32.0	34.5	24.0	6EX8FJX90S
-8	12	1/2	3/4" - 16 UNF	72.5	40.5	43.0	24.0	8EX8FJX90S
-8	12	1/2	7/8" - 14 UNF	73.5	41.5	42.5	27.0	8EX10FJX90S
-8	12	1/2	1.1/16" - 12 UN	71.0	39.0	47.0	32.0	8EX12FJX90S
-10	16	5/8	7/8" - 14 UNF	78.5	44.0	47.0	27.0	10EX10FJX90S
-10	16	5/8	1.1/16" - 12 UN	81.5	47.0	48.0	32.0	10EX12FJX90S
-12	20	3/4	1.1/16" - 12 UN	89.5	50.0	50.0	32.0	12EX12FJX90S
-16	25	1	1.5/16" - 12 UN	122.0	68.5	70.0	38.0	16EX16FJX90S

S: Short drop per ISO 12151-5.

Unless otherwise stated the coupling meets the pressure rating requirements of the respective international standard.

TABLE OF CONTENTS

ABOUT GATES

HYDRAULIC HOSE

HYDRAULIC HOSE COUPLINGS

ENGINEERING AND TECHNICAL DATA

JIC 37° MJ

Male JIC parallel. 37° cone.

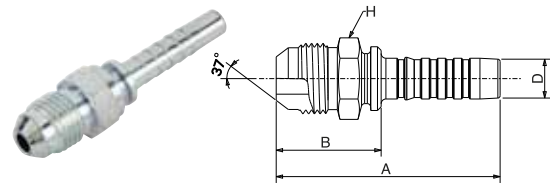

D				A	B	H	REF.
-size	DN	"		mm	mm	mm	EX
-4	6	1/4	7/16" - 20 UNF	54.5	26.5	12.0	4EX4MJ
-4	6	1/4	1/2" - 20 UNF	55.5	27.5	14.0	4EX5MJ
-4	6	1/4	9/16" - 18 UNF	55.5	27.5	15.0	4EX6MJ
-6	10	3/8	9/16" - 18 UNF	58.0	28.0	15.0	6EX6MJ
-6	10	3/8	3/4" - 16 UNF	63.0	33.0	19.0	6EX8MJ
-6	10	3/8	7/8" - 14 UNF	66.0	36.0	24.0	6EX10MJ
-8	12	1/2	3/4" - 16 UNF	65.5	33.5	19.0	8EX8MJ
-8	12	1/2	7/8" - 14 UNF	68.5	36.5	24.0	8EX10MJ
-8	12	1/2	1.1/16" - 12 UN	70.5	38.5	27.0	8EX12MJ
-10	16	5/8	7/8" - 14 UNF	71.0	36.5	24.0	10EX10MJ
-10	16	5/8	1.1/16" - 12 UN	73.0	38.5	27.0	10EX12MJ
-12	20	3/4	1.1/16" - 12 UN	79.0	39.5	27.0	12EX12MJ
-16	25	1	1.5/16" - 12 UN	97.0	43.5	34.0	16EX16MJ

Unless otherwise stated the coupling meets the pressure rating requirements of the respective international standard.

SAE FFORX

Female SAE flat face 'O' ring swivel.

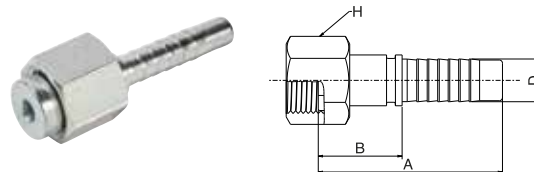

↻			🌀	↔			🔌
D				A	B	H	REF.
-size	DN	"		mm	mm	mm	EX
-4	6	1/4	9/16" - 18 UNF	49.5	21.5	17.0	4EX4FFORX
-4	6	1/4	11/16" - 16 UN	51.0	23.0	22.0	4EX6FFORX
-6	10	3/8	11/16" - 16 UN	53.0	23.0	22.0	6EX6FFORX
-6	10	3/8	13/16" - 16 UN	56.0	26.0	24.0	6EX8FFORX
-8	12	1/2	13/16" - 16 UN	57.5	25.5	24.0	8EX8FFORX
-8	12	1/2	1" - 14 UNS	61.5	29.5	30.0	8EX10FFORX
-8	12	1/2	1" - 14 UNS	64.0	29.5	30.0	10EX10FFORX
-10	16	5/8	1.3/16" - 12 UN	72.5	33.0	36.0	12EX12FFORX
-12	20	3/4	1.7/16" - 12 UN	73.5	34.0	41.0	12EX16FFORX
-16	25	1	1.7/16" - 12 UN	88.5	35.0	41.0	16EX16FFORX

SAE FFORX45S

Female SAE flat face 'O' ring swivel.
45° swept elbow. Short drop.

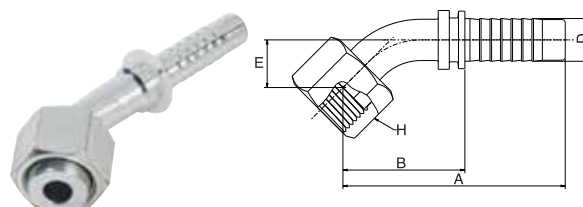

↻			🌀	↔				🔌
D				A	B	E	H	REF.
-size	DN	"		mm	mm	mm	mm	EX
-4	6	1/4	9/16" - 18 UNF	73.0	45.0	15.0	17.0	4EX4FFORX45S
-4	6	1/4	11/16" - 16 UN	73.0	45.0	15.0	22.0	4EX6FFORX45S
-6	10	3/8	11/16" - 16 UN	81.0	51.0	13.0	22.0	6EX6FFORX45S
-6	10	3/8	13/16" - 16 UN	82.0	52.0	17.0	24.0	6EX8FFORX45S
-8	12	1/2	13/16" - 16 UN	90.0	58.0	18.0	24.0	8EX8FFORX45S
-8	12	1/2	1" - 14 UNS	93.0	61.0	20.0	30.0	8EX10FFORX45S
-10	16	5/8	1" - 14 UNS	89.5	55.0	20.0	30.0	10EX10FFORX45S
-12	20	3/4	1.3/16" - 12 UN	97.5	58.0	23.0	36.0	12EX12FFORX45S
-16	25	1	1.7/16" - 12 UN	134.5	81.0	26.0	41.0	16EX16FFORX45S

S: Short drop per ISO 12151-1.

Unless otherwise stated the coupling meets the pressure rating requirements of the respective international standard.

SAE FFORX90S

Female SAE flat face 'O' ring swivel.
90° swept elbow. Short drop.

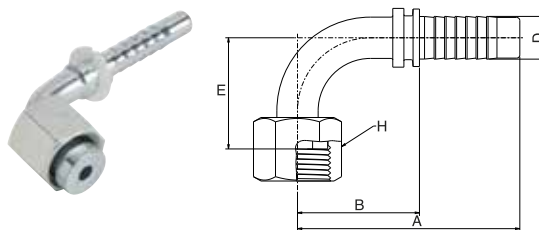

↻			🌀	↔				🔧
D				A	B	E	H	REF.
-size	DN	"		mm	mm	mm	mm	EX
-4	6	1/4	9/16" - 18 UNF	51.5	23.5	26.5	17.0	4EX4FFORX90S
-4	6	1/4	11/16" - 16 UN	57.0	29.0	27.0	22.0	4EX6FFORX90S
-6	10	3/8	11/16" - 16 UN	60.0	30.0	31.0	22.0	6EX6FFORX90S
-6	10	3/8	13/16" - 16 UN	63.0	33.0	31.0	24.0	6EX8FFORX90S
-8	12	1/2	13/16" - 16 UN	71.0	39.0	37.0	24.0	8EX8FFORX90S
-8	12	1/2	1" - 14 UNS	73.0	41.0	38.0	30.0	8EX10FFORX90S
-10	16	5/8	1" - 14 UNS	80.5	46.0	38.0	30.0	10EX10FFORX90S
-12	20	3/4	1.3/16" - 12 UN	93.5	54.0	49.5	36.0	12EX12FFORX90S
-16	25	1	1.7/16" - 12 UN	117.5	64.0	61.0	41.0	16EX16FFORX90S

S: Short drop per ISO 12151-1.

SAE MFFOR

Male SAE flat face 'O' ring.

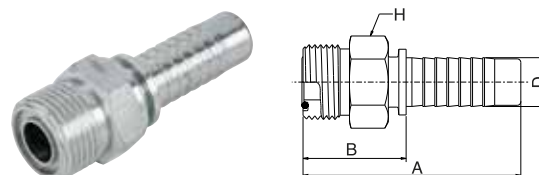

↻			🌀	↔			🔧
D				A	B	H	REF.
-size	DN	"		mm	mm	mm	EX
-4	6	1/4	9/16" - 18 UNF	52.0	24.0	17.0	4EX4MFFOR
-6	10	3/8	11/16" - 16 UN	57.5	27.5	19.0	6EX6MFFOR
-8	12	1/2	13/16" - 16 UN	61.0	29.0	22.0	8EX8MFFOR
-10	16	5/8	1" - 14 UNS	68.5	34.0	27.0	10EX10MFFOR
-12	20	3/4	1.3/16" - 12 UN	77.5	38.0	32.0	12EX12MFFOR
-16	25	1	1.7/16" - 12 UN	93.0	39.4	71.0	16EX16MFFOR

Unless otherwise stated the coupling meets the pressure rating requirements of the respective international standard.

DIN 24° FDLORX

Female DIN 'O' ring swivel. 24° cone.
Light series.

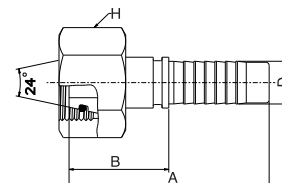

D				A	B	H	REF.
-size	DN	"		mm	mm	mm	EX
-4	6	1/4	M12 x 1.5	47.7	19.7	14.0	4EX6FDLORX
-4	6	1/4	M14 x 1.5	53.8	25.8	17.0	4EX8FDLORX
-4	6	1/4	M16 x 1.5	54.0	26.0	19.0	4EX10FDLORX
-4	6	1/4	M18 x 1.5	54.5	26.5	22.0	4EX12FDLORX
-5	8	5/16	M16 x 1.5	54.0	26.0	19.0	5EX10FDLORX
-5	8	5/16	M18 x 1.5	54.5	26.5	22.0	5EX12FDLORX
-6	10	3/8	M16 x 1.5	56.5	26.5	19.0	6EX10FDLORX
-6	10	3/8	M18 x 1.5	56.5	26.5	22.0	6EX12FDLORX
-6	10	3/8	M22 x 1.5	57.0	27.0	27.0	6EX15FDLORX
-8	12	1/2	M22 x 1.5	60.1	28.1	22.0	8EX15FDLORX
-8	12	1/2	M26 x 1.5	60.3	28.3	32.0	8EX18FDLORX
-10	16	5/8	M26 x 1.5	62.8	28.3	32.0	10EX18FDLORX
-12	20	3/4	M30 x 2.0	70.6	31.1	36.0	12EX22FDLORX
-16	25	1	M36 x 2.0	86.2	32.7	41.0	16EX28FDLORX

Unless otherwise stated the coupling meets the pressure rating requirements of the respective international standard.

TABLE OF CONTENTS

ABOUT GATES

HYDRAULIC HOSE

HYDRAULIC HOSE COUPLINGS

ENGINEERING AND TECHNICAL DATA

DIN 24° FDLORX45

Female DIN 'O' ring swivel. 24° cone.
Light series. 45° swept elbow.

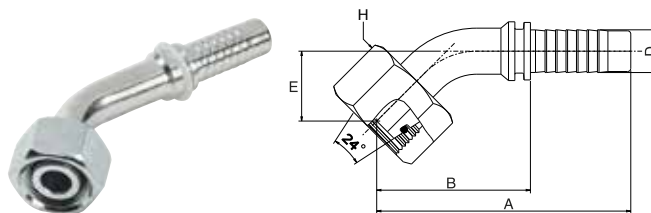

D				A	B	E	H	REF.
-size	DN	"		mm	mm	mm	mm	EX
-4	6	1/4	M12 x 1.5	68.0	40.0	17.0	17.0	4EX6FDLORX45
-4	6	1/4	M14 x 1.5	73.0	45.0	17.0	17.0	4EX8FDLORX45
-4	6	1/4	M16 x 1.5	76.5	48.5	17.0	19.0	4EX10FDLORX45
-4	6	1/4	M18 x 1.5	76.5	48.5	17.0	22.0	4EX12FDLORX45
-5	8	5/16	M16 x 1.5	80.5	52.5	17.0	19.0	5EX10FDLORX45
-5	8	5/16	M18 x 1.5	78.0	50.0	20.0	22.0	5EX12FDLORX45
-6	10	3/8	M16 x 1.5	85.0	55.0	20.0	19.0	6EX10FDLORX45
-6	10	3/8	M18 x 1.5	87.0	57.0	17.0	22.0	6EX12FDLORX45
-6	10	3/8	M22 x 1.5	89.0	59.0	19.0	27.0	6EX15FDLORX45
-8	12	1/2	M22 x 1.5	96.0	64.0	22.0	27.0	8EX15FDLORX45
-8	12	1/2	M26 x 1.5	97.0	65.0	26.0	32.0	8EX18FDLORX45
-10	16	5/8	M26 x 1.5	96.0	61.5	28.0	32.0	10EX18FDLORX45
-12	20	3/4	M30 x 2.0	102.5	63.0	27.0	36.0	12EX22FDLORX45
-16	25	1	M36 x 2.0	139.0	85.5	38.5	41.0	16EX28FDLORX45

Unless otherwise stated the coupling meets the pressure rating requirements of the respective international standard.

DIN 24° FDLORX90

Female DIN 'O' ring swivel. 24° cone.
Light series. 90° swept elbow.

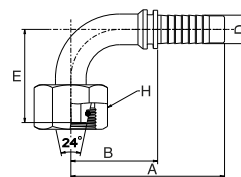

D				A	B	E	H	REF.
-size	DN	"		mm	mm	mm	mm	EX
-4	6	1/4	M12 x 1.5	51.5	23.5	31.0	17.0	4EX6FDLORX90
-4	6	1/4	M14 x 1.5	53.5	25.5	31.5	17.0	4EX8FDLORX90
-4	6	1/4	M16 x 1.5	57.0	29.0	29.0	19.0	4EX10FDLORX90
-4	6	1/4	M18 x 1.5	57.0	29.0	33.0	22.0	4EX12FDLORX90
-5	8	5/16	M16 x 1.5	56.5	28.5	32.0	19.0	5EX10FDLORX90
-5	8	5/16	M18 x 1.5	56.5	28.5	33.0	22.0	5EX12FDLORX90
-6	10	3/8	M16 x 1.5	63.5	33.5	33.5	19.0	6EX10FDLORX90
-6	10	3/8	M18 x 1.5	63.5	33.5	33.5	22.0	6EX12FDLORX90
-6	10	3/8	M22 x 1.5	60.5	30.5	38.0	27.0	6EX15FDLORX90
-8	12	1/2	M22 x 1.5	73.0	41.0	43.0	27.0	8EX15FDLORX90
-8	12	1/2	M26 x 1.5	74.5	42.5	43.0	32.0	8EX18FDLORX90
-10	16	5/8	M26 x 1.5	80.5	46.0	46.0	32.0	10EX18FDLORX90
-12	20	3/4	M30 x 2.0	89.5	50.0	52.5	36.0	12EX22FDLORX90
-16	25	1	M36 x 2.0	120.5	67.0	65.0	41.0	16EX28FDLORX90

Unless otherwise stated the coupling meets the pressure rating requirements of the respective international standard.

TABLE OF CONTENTS
ABOUT GATES
HYDRAULIC HOSE
HYDRAULIC HOSE COUPLINGS
ENGINEERING AND TECHNICAL DATA

DIN 24° MDL

Male DIN parallel. 24° inverted cone.
Light series.

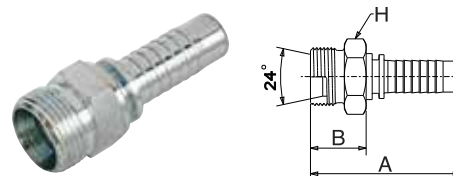

D				A	B	H	REF.
-size	DN	"		mm	mm	mm	EX
-4	6	1/4	M12 x 1.5	50.5	22.5	14.0	4EX6MDL
-4	6	1/4	M14 x 1.5	50.5	22.5	14.0	4EX8MDL
-4	6	1/4	M16 x 1.5	53.0	25.0	17.0	4EX10MDL
-4	6	1/4	M18 x 1.5	53.5	25.5	19.0	4EX12MDL
-5	8	5/16	M16 x 1.5	53.0	25.0	17.0	5EX10MDL
-5	8	5/16	M18 x 1.5	54.0	26.0	19.0	5EX12MDL
-6	10	3/8	M16 x 1.5	54.0	24.0	17.0	6EX10MDL
-6	10	3/8	M18 x 1.5	56.0	26.0	19.0	6EX12MDL
-6	10	3/8	M22 x 1.5	57.0	27.0	22.0	6EX15MDL
-8	12	1/2	M22 x 1.5	59.5	27.5	22.0	8EX15MDL
-8	12	1/2	M26 x 1.5	60.0	28.0	27.0	8EX18MDL
-10	16	5/8	M26 x 1.5	63.0	28.5	27.0	10EX18MDL
-12	20	3/4	M26 x 1.5	63.0	28.5	27.0	12EX18MDL
-12	20	3/4	M30 x 2.0	72.0	32.5	30.0	12EX22MDL
-16	25	1	M36 x 2.0	88.0	34.5	36.0	16EX28MDL

Unless otherwise stated the coupling meets the pressure rating requirements of the respective international standard.

DIN 24° FDHORX

Female DIN 'O' ring swivel. 24° cone.
Heavy series.

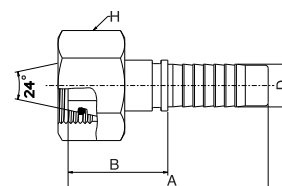

D				A	B	H	REF.
-size	DN	"		mm	mm	mm	EX
-4	6	1/4	M14 x 1.5	53.7	25.7	17.0	4EX6FDHORX
-4	6	1/4	M16 x 1.5	53.8	25.8	19.0	4EX8FDHORX
-4	6	1/4	M18 x 1.5	54.0	26.0	22.0	4EX10FDHORX
-5	8	5/16	M20 x 1.5	54.4	26.5	24.0	5EX12FDHORX
-6	10	3/8	M18 x 1.5	56.5	26.5	22.0	6EX10FDHORX
-6	10	3/8	M20 x 1.5	56.5	26.5	24.0	6EX12FDHORX
-6	10	3/8	M22 x 1.5	59.5	29.5	27.0	6EX14FDHORX
-8	12	1/2	M22 x 1.5	60.0	28.0	27.0	8EX14FDHORX
-8	12	1/2	M24 x 1.5	63.0	31.0	30.0	8EX16FDHORX
-10	16	5/8	M30 x 2.0	71.0	36.5	36.0	10EX20FDHORX
-12	20	3/4	M30 x 2.0	75.5	36.0	36.0	12EX20FDHORX
-12	20	3/4	M36 x 2.0	77.6	38.1	46.0	12EX25FDHORX
-16	25	1	M36 x 2.0	93.0	39.5	46.0	16EX25FDHORX
-16	25	1	M42 x 2.0	95.1	41.6	50.0	16EX30FDHORX

Unless otherwise stated the coupling meets the pressure rating requirements of the respective international standard.

DIN 24° FDHORX45

Female DIN 'O' ring swivel. 24° cone.
Heavy series. 45° swept elbow.

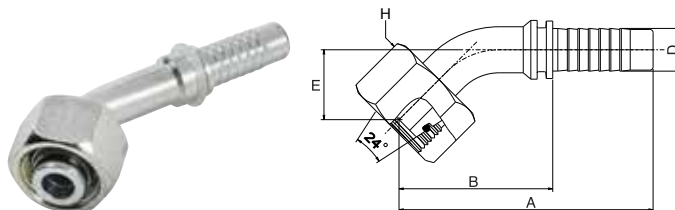

D				A	B	E	H	REF.
-size	DN	"		mm	mm	mm	mm	EX
-4	6	1/4	M16 x 1.5	78.0	50.0	17.0	19.0	4EX8FDHORX45
-4	6	1/4	M18 x 1.5	76.5	48.5	17.0	22.0	4EX10FDHORX45
-5	8	5/16	M20 x 1.5	78.0	50.0	20.0	24.0	5EX12FDHORX45
-6	10	3/8	M18 x 1.5	87.0	57.0	17.0	22.0	6EX10FDHORX45
-6	10	3/8	M20 x 1.5	87.0	57.0	17.0	24.0	6EX12FDHORX45
-6	10	3/8	M22 x 1.5	87.0	59.0	19.0	27.0	6EX14FDHORX45
-8	12	1/2	M24 x 1.5	98.5	66.5	22.0	30.0	8EX16FDHORX45
-10	16	5/8	M30 x 2.0	99.0	64.5	26.0	36.0	10EX20FDHORX45
-12	20	3/4	M30 x 2.0	103.5	64.0	27.0	36.0	12EX20FDHORX45
-12	20	3/4	M36 x 2.0	109.5	70.0	28.0	46.0	12EX25FDHORX45
-16	25	1	M36 x 2.0	142.0	88.5	38.0	46.0	16EX25FDHORX45
-16	25	1	M42 x 2.0	142.5	89.0	38.0	50.0	16EX30FDHORX45

Unless otherwise stated the coupling meets the pressure rating requirements of the respective international standard.

DIN 24° FDHORX90

Female DIN 'O' ring swivel. 24° cone.
Heavy series. 90° swept elbow.

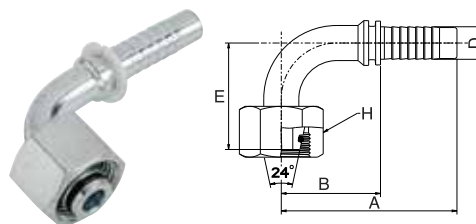

↻			🌀	↔				📏
D				A	B	E	H	REF.
-size	DN	"		mm	mm	mm	mm	EX
-4	6	1/4	M16 x 1.5	53.5	25.5	31.0	19.0	4EX8FDHORX90
-4	6	1/4	M18 x 1.5	57.0	29.0	29.0	22.0	4EX10FDHORX90
-5	8	5/16	M20 x 1.5	56.5	28.5	33.0	24.0	5EX12FDHORX90
-6	10	3/8	M18 x 1.5	63.5	33.5	33.5	22.0	6EX10FDHORX90
-6	10	3/8	M20 x 1.5	63.5	33.5	33.5	24.0	6EX12FDHORX90
-6	10	3/8	M22 x 1.5	63.5	33.5	42.0	27.0	6EX14FDHORX90
-8	12	1/2	M24 x 1.5	73.0	41.0	43.0	30.0	8EX16FDHORX90
-10	16	5/8	M30 x 2.0	82.5	48.0	48.0	36.0	10EX20FDHORX90
-12	20	3/4	M30 x 2.0	89.5	50.0	28.0	36.0	12EX20FDHORX90
-12	20	3/4	M36 x 2.0	89.5	50.0	58.0	46.0	12EX25FDHORX90
-16	25	1	M36 x 2.0	126.5	73.0	70.0	46.0	16EX25FDHORX90
-16	25	1	M42 x 2.0	126.5	73.0	70.0	50.0	16EX30FDHORX90

Unless otherwise stated the coupling meets the pressure rating requirements of the respective international standard.

TABLE OF CONTENTS

ABOUT GATES

HYDRAULIC HOSE

HYDRAULIC HOSE COUPLINGS

ENGINEERING AND TECHNICAL DATA

DIN 24° MDH

Male DIN parallel. 24° inverted cone.
Heavy series.

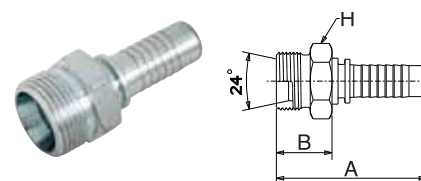

D				A	B	H	REF.
-size	DN	"		mm	mm	mm	EX
-4	6	1/4	M16 x 1.5	53.5	25.5	17.0	4EX8MDH
-4	6	1/4	M18 x 1.5	54.5	26.5	19.0	4EX10MDH
-5	8	5/16	M20 x 1.5	55.0	27.0	22.0	5EX12MDH
-6	10	3/8	M18 x 1.5	57.0	27.0	19.0	6EX10MDH
-6	10	3/8	M20 x 1.5	57.0	27.0	22.0	6EX12MDH
-6	10	3/8	M22 x 1.5	59.0	29.0	22.0	6EX14MDH
-8	12	1/2	M24 x 1.5	62.5	30.5	24.0	8EX16MDH
-10	16	5/8	M30 x 2.0	68.0	33.5	30.0	10EX20MDH
-12	20	3/4	M30 x 2.0	73.5	34.0	30.0	12EX20MDH
-12	20	3/4	M36 x 2.0	77.2	37.7	36.0	12EX25MDH
-16	25	1	M36 x 2.0	92.0	38.5	36.0	16EX25MDH
-16	25	1	M42 x 2.0	94.0	40.5	46.0	16EX30MDH

METRIC MSP

Metric standpipe.

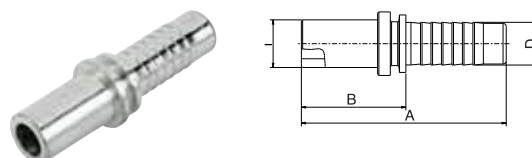

D			I	A	B	REF.	
-size	DN	"	mm	mm	mm	EX	
-4	6	1/4	L6	56.5	28.5	4EX6MSP	
-4	6	1/4	L8	56.5	28.5	4EX8MSP	
-6	10	3/8	L10	60.0	30.0	6EX10MSP	
-6	10	3/8	L12	60.0	30.0	6EX12MSP	
-8	12	1/2	L15	64.5	32.5	8EX15MSP	
-10	16	5/8	L18	68.0	33.5	10EX18MSP	
-12	20	3/4	L22	76.0	36.5	12EX22MSP	

Unless otherwise stated the coupling meets the pressure rating requirements of the respective international standard.



METRIC DBJ

Metric banjo.

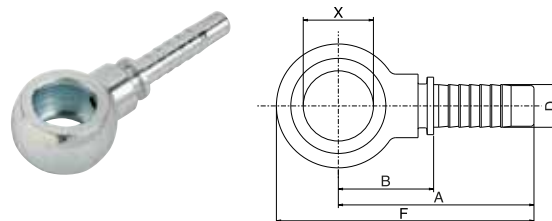

↔			↻	↔				↻
D				A	B	F	X	REF.
-size	DN	"		mm	mm	mm	mm	EX
-4	6	1/4	M10	50.5	22.5	59.0	10.1	4EX10DBJ
-4	6	1/4	M12	47.5	19.5	57.7	12.1	4EX12DBJ
-4	6	1/4	M14	49.5	21.5	61.5	14.1	4EX14DBJ
-6	10	3/8	M14	58.0	28.0	70.0	14.1	6EX14DBJ
-6	10	3/8	M16	54.5	24.5	68.5	16.1	6EX16DBJ
-6	10	3/8	M18	57.5	27.5	73.5	18.1	6EX18DBJ
-8	12	1/2	M18	60.0	28.0	76.0	18.1	8EX18DBJ
-8	12	1/2	M22	62.0	30.0	79.5	22.1	8EX22DBJ

NPTF MP

Male NPTF pipe.

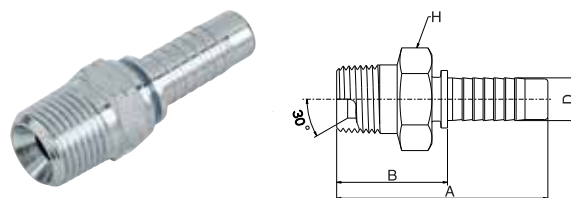

↔			↻	↔			↻
D				A	B	H	REF.
-size	DN	"		mm	mm	mm	EX
-4	6	1/4	1/4" - 18 NPTF	54.5	26.5	15.0	4EX4MP
-4	6	1/4	3/8" - 18 NPTF	55.5	27.5	19.0	4EX6MP
-6	10	3/8	3/8" - 18 NPTF	58.0	28.0	19.0	6EX6MP
-6	10	3/8	1/2" - 14 NPTF	64.0	34.0	22.0	6EX8MP
-8	12	1/2	1/2" - 14 NPTF	66.5	34.5	22.0	8EX8MP
-12	20	3/4	3/4" - 14 NPTF	76.0	36.5	27.0	12EX12MP
-16	25	1	1" - 11.5 NPTF	97.0	43.5	36.0	16EX16MP

Warning: Use only in NPTF connections. Do not use in oil field (API) connections. Blow apart of an oil field connection can result in serious injuries.

Unless otherwise stated the coupling meets the pressure rating requirements of the respective international standard.

TABLE OF CONTENTS

ABOUT GATES

HYDRAULIC HOSE

HYDRAULIC HOSE COUPLINGS

ENGINEERING AND TECHNICAL DATA



ACCESSORIES

FLANGE KITS



SAE PA-FL FLANGE KIT

SAE flange kit. Code 61. SAE standard pressure.

Each kit comprises:

- 2 flange halves (PA-FL75)
- 4 bolts
- 4 washers
- 'O' ring (PA-FL77)

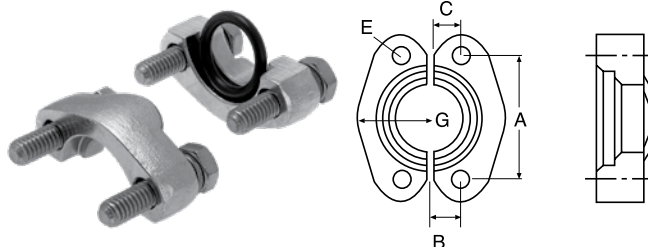

↔			⌚	↔				⌚
D				A	B	D	E	REF.
-size	DN	"	MPa	mm	mm	mm	mm	PA-FL
-8	12	1/2	35.0	38.1	8.8	54.0	8.9	08PA-FL
-12	20	3/4	35.0	47.6	11.1	65.1	10.6	12PA-FL
-16	25	1	35.0	52.4	13.1	69.9	10.6	16PA-FL
-20	32	1.1/4	28.0	58.7	15.1	79.4	12.0	20PA-FL
-24	40	1.1/2	21.0	69.9	17.9	93.8	13.3	24PA-FL
-32	50	2	21.0	77.8	21.5	101.6	13.5	32PA-FL

Code 61: -16 size is 35.0 MPa (5000 psi).

SAE PH-FLH FLANGE KIT

SAE flange kit. Code 62. SAE high pressure.

Each kit comprises:

- 2 flange halves (PH-FLH75)
- 4 bolts
- 4 washers
- 'O' ring (PH-FLH77)

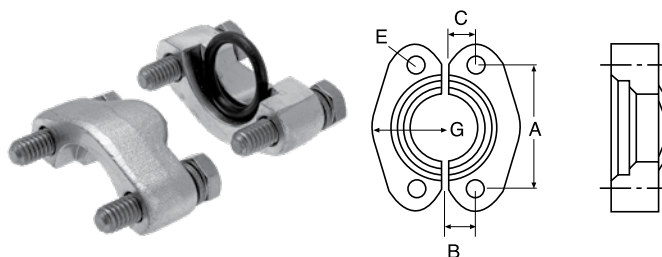

↔			⌚	↔				⌚
D				A	B	D	E	REF.
-size	DN	"	MPa	mm	mm	mm	mm	PH-FLH
-8	12	1/2	42.0	40.5	9.1	56.4	8.9	08PH-FLH
-12	20	3/4	42.0	50.8	11.9	71.4	10.6	12PH-FLH
-16	25	1	42.0	57.2	13.9	81.1	12.0	16PH-FLH
-20	32	1.1/4	42.0	66.7	15.9	95.3	13.3	20PH-FLH
-24	40	1.1/2	42.0	79.4	18.3	112.8	16.7	24PH-FLH
-32	50	2	42.0	96.8	22.3	133.4	20.6	32PH-FLH

Unless otherwise stated the coupling meets the pressure rating requirements of the respective international standard.

FLANGE KITS



SAE PH-FLH MONOBLOC KIT

SAE flange kit. Code 62 (metric). SAE high pressure.

Each kit comprises:

- dual flange
- 4 bolts
- 4 washers
- 'O' ring

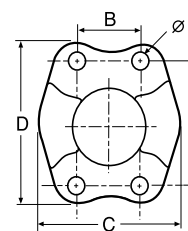





↻			⊙	↔					⊕
D				A	B	C	D	E	REF.
-size	DN	"	MPa	mm	mm	mm	mm	mm	FLHCFM
-8	12	1/2	40.0	40.5	18.2	47.8	56.4	8.9	08FLHCFM MONOBLOC
-12	19	3/4	40.0	50.8	23.8	60.5	71.4	10.6	12FLHCFM MONOBLOC
-16	25	1	40.0	57.2	27.8	69.9	81.1	13.3	16FLHCFM MONOBLOC
-20	32	1.1/4	40.0	66.7	31.8	77.7	95.3	13.3	20FLHCFM MONOBLOC
-24	40	1.1/2	40.0	79.4	36.5	95.3	112.8	16.7	24FLHCFM MONOBLOC
-32	50	2	40.0	96.8	44.5	114.3	133.4	20.6	32FLHCFM MONOBLOC

Unless otherwise stated the coupling meets the pressure rating requirements of the respective international standard.

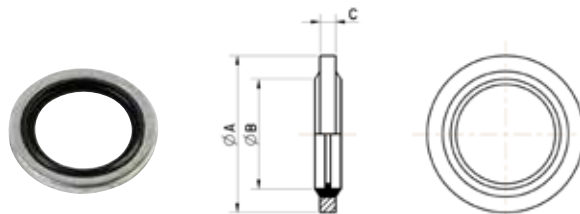





BSP BONDED SEAL

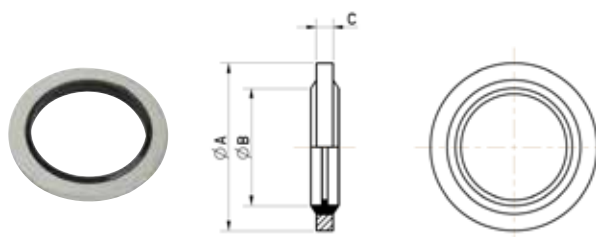

				
	A	B	W	REF.
	mm	mm	mm	BONDED SEAL
1/8" BSP	15.9	10.4	2.0	BONDED SEAL 1/8" BSP
1/4" BSP	20.6	13.7	2.0	BONDED SEAL 1/4" BSP
3/8" BSP	23.8	17.3	2.0	BONDED SEAL 3/8" BSP
1/2" BSP	28.6	21.5	2.5	BONDED SEAL 1/2" BSP
5/8" BSP	25.4	16.5	2.0	BONDED SEAL 5/8" BSP
3/4" BSP	34.9	27.1	2.5	BONDED SEAL 3/4" BSP
1" BSP	42.8	33.9	3.3	BONDED SEAL 1" BSP

DIN BONDED SEAL





				
	A	B	W	REF.
	mm	mm	mm	BONDED SEAL
M10	17.0	10.7	1.5	BONDED SEAL M10
M12	18.0	12.7	1.5	BONDED SEAL M12
M14	22.0	14.7	1.5	BONDED SEAL M14
M16	24.0	16.7	1.5	BONDED SEAL M16
M18	26.0	18.7	1.5	BONDED SEAL M18
M22	30.0	22.7	2.0	BONDED SEAL M22
M26	35.0	26.7	2.0	BONDED SEAL M26
M30	39.0	30.7	2.0	BONDED SEAL M30

Unless otherwise stated the coupling meets the pressure rating requirements of the respective international standard.

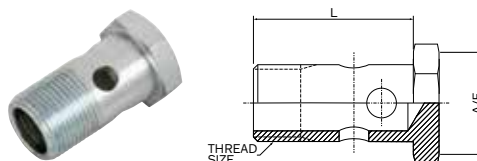

BSP SINGLE HOLE BANJO BOLT

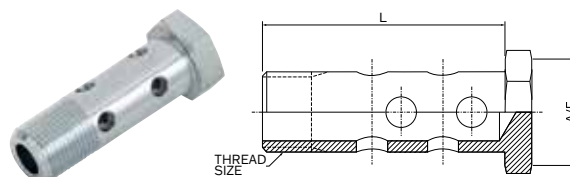

				
	A	B	H	REF.
	mm	mm	mm	BANJO BOLT
1/8" - BSP	24.0	19.0	14.0	BSP SINGLE BANJO BOLT 1/8"
1/4" - BSP	34.5	28.0	19.0	BSP SINGLE BANJO BOLT 1/4"
3/8" - BSP	37.5	31.0	22.0	BSP SINGLE BANJO BOLT 3/8"
1/2" - BSP	46.0	38.0	27.0	BSP SINGLE BANJO BOLT 1/2"
5/8" - BSP	49.0	41.0	30.0	BSP SINGLE BANJO BOLT 5/8"
3/4" - BSP	56.0	46.0	32.0	BSP SINGLE BANJO BOLT 3/4"
1" - BSP	69.0	57.0	41.0	BSP SINGLE BANJO BOLT 1"

BSP DOUBLE HOLE BANJO BOLT





				
	A	B	H	REF.
	mm	mm	mm	BANJO BOLT
1/8" - BSP	35.5	30.5	14.0	BSP DOUBLE BANJO BOLT 1/8"
1/4" - BSP	49.5	43.0	19.0	BSP DOUBLE BANJO BOLT 1/4"
3/8" - BSP	58.0	51.0	22.0	BSP DOUBLE BANJO BOLT 3/8"
1/2" - BSP	73.0	64.0	27.0	BSP DOUBLE BANJO BOLT 1/2"
3/4" - BSP	92.0	81.0	32.0	BSP DOUBLE BANJO BOLT 3/4"
1" - BSP	110.0	96.0	41.0	BSP DOUBLE BANJO BOLT 1"

Unless otherwise stated the coupling meets the pressure rating requirements of the respective international standard.

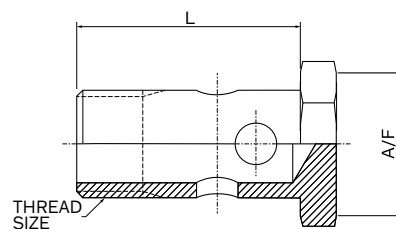

METRIC SINGLE HOLE BANJO BOLT

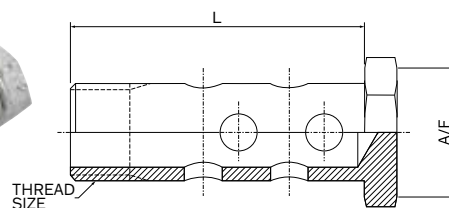

				
	A	B	H	REF.
	mm	mm	mm	BANJO BOLT
M10 x 1.5	24.5	19.5	14.0	METRIC SNGL BANJO BOLT M10x1,5
M12 x 1.5	31.0	24.5	17.0	METRIC SNGL BANJO BOLT M12x1,5
M14 x 1.5	32.0	26.0	19.0	METRIC SNGL BANJO BOLT M14x1,5
M16 x 1.5	34.0	28.0	22.0	METRIC SNGL BANJO BOLT M16x1,5
M18 x 1.5	44.0	36.0	24.0	METRIC SNGL BANJO BOLT M18x1,5
M22 x 1.5	46.0	39.0	27.0	METRIC SNGL BANJO BOLT M22x1,5
M26 x 1.5	56.0	46.0	32.0	METRIC SNGL BANJO BOLT M26x1,5
M30 x 1.5	58.0	51.0	36.0	METRIC SNGL BANJO BOLT M30x1,5

METRIC DOUBLE HOLE BANJO BOLT



				
	A	B	H	REF.
	mm	mm	mm	BANJO BOLT
M10 x 1.5	38.0	33.0	14.0	METRIC DBL BANJO BOLT M10x1,5
M12 x 1.5	43.0	37.0	17.0	METRIC DBL BANJO BOLT M12x1,5
M14 x 1.5	49.5	43.0	19.0	METRIC DBL BANJO BOLT M14x1,5
M16 x 1.5	58.0	50.0	22.0	METRIC DBL BANJO BOLT M16x1,5
M18 x 1.5	66.0	58.0	24.0	METRIC DBL BANJO BOLT M18x1,5
M22 x 1.5	73.0	64.0	27.0	METRIC DBL BANJO BOLT M22x1,5

Unless otherwise stated the coupling meets the pressure rating requirements of the respective international standard.



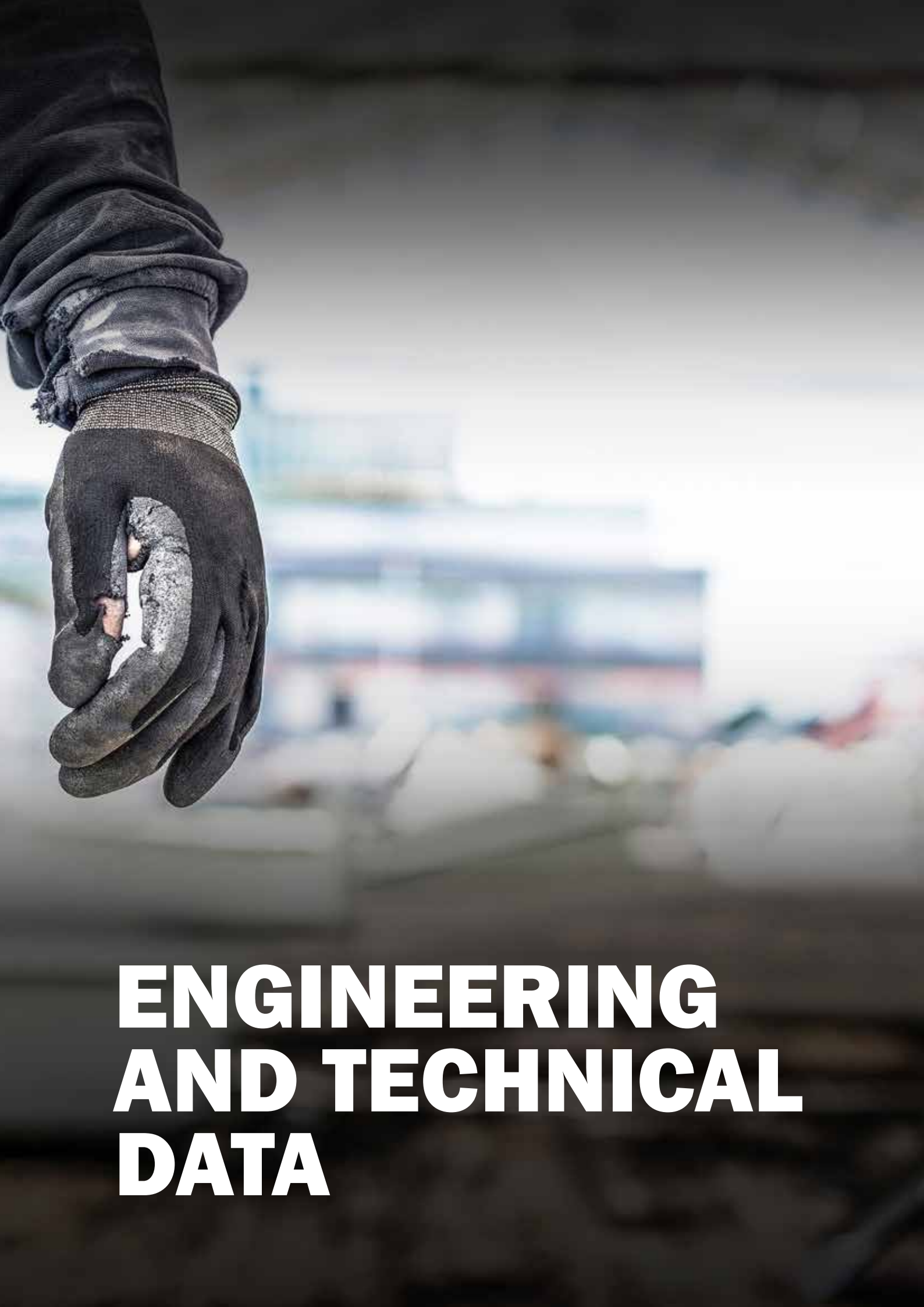

ENGINEERING AND TECHNICAL DATA



CHEMICAL RESISTANCE TABLE



CHEMICAL RESISTANCE TABLE

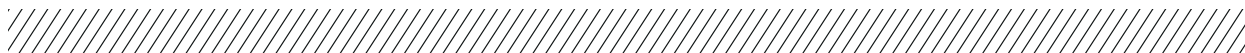

CHEMICAL	FORM (AT ROOM TEMPERATURE UNLESS OTHERWISE STATED)	GATES HOSE / POLYMERS														COUPLINGS					
		Teflon®	XLPE	UHMWPE	EPDM	NR	SBR	NR	CR	Butyl	Fluorocarbon	Hypalon®	CPE	Nylon	PVC	Iron/Carbon Steel	Stainless Steel 304	Stainless Steel 316	Aluminum	Brass	Polypro
		A																			
Absorption Oil	Liquid	1	2	2	X	1	X	X	2	X	1	2	1	1	-	-	-	-	-	1	-
Acetal	Colorless Liquid	1	1	1	1	-	-	-	-	1	X	-	1	-	-	-	-	-	-	1	-
Acetaldehyde	Colorless Liquid	1	1	1	1	X	2	2	X	1	X	X	1	2	X	1	1	1	1	1	1
Acetamide	Liquid above 176°F(80°C)	1	1	2	2	2	X	X	2	2	X	-	1	-	-	-	2	-	1	X	-
Acetic Acid (40% or less)	Clear Colorless Liquid	1	1	1	1	X	2	X	2	1	X	2	1	-	-	X	2	2	2	X	2
Acetic Acid (56% or less)	Clear Colorless Liquid	1	1	1	1	X	2	X	2	1	X	2	1	X	2	X	2	2	2	X	2
Acetic Acid (85% or less)	Clear Colorless Liquid	1	1	1	2	X	2	X	X	X	X	X	X	X	X	-	2	2	-	-	X
Acetic Acid (Glacial - 99.4%)	Clear Colorless Liquid	1	1	X	X	X	2	X	X	X	X	X	1	X	X	-	2	2	-	-	X
Acetic Acid, Anhydride	Clear Colorless Liquid	1	-	X	-	X	X	X	X	2	-	2	1	X	X	-	2	2	-	-	X
Acetic Anhydride (Acetic Oxide)	Colorless Liquid	1	1	1	1	X	X	X	-	2	X	2	1	X	X	X	2	2	2	X	X
Acetic Ether (Ethyl Acetate)	Colorless Liquid	1	1	1	2	X	X	X	X	2	X	X	2	1	X	1	1	1	1	1	2
Acetic Oxide (Acetic Anhydride)	Colorless Liquid	1	1	1	1	-	X	X	-	2	X	2	1	X	X	X	2	2	2	X	X
Acetone (Dimethylketone)	Colorless Liquid	1	1	X	2	X	X	X	X	2	X	X	1	1	X	1	1	1	1	1	2
Acetone Cyanohydrin	Colorless Liquid	1	1	2	2	-	X	X	-	2	-	-	2	-	-	-	-	-	-	-	-
Acetonitrile (Methyl Cyanide)	Colorless Liquid	1	1	2	X	X	2	2	2	2	-	2	1	-	1	-	-	-	-	-	-
Acetophenone	Colorless Liquid	1	2	2	1	X	X	X	X	1	X	-	-	-	-	-	-	-	-	-	2
Acetyl Chloride	Colorless Liquid	1	-	-	-	-	-	-	-	-	1	-	-	-	-	-	-	-	-	-	-
Acetyl Oxide (Acetic Anhydride)	Colorless Liquid	1	1	1	1	X	X	X	-	2	X	2	1	X	X	X	2	2	2	X	X
Acetyl-P-Toluidine (In Ether or Alcohols)	In Alcohol or Ether	1	1	1	1	-	X	X	-	2	X	-	1	-	-	-	-	-	-	-	-
Acetylene	Gas	NO HOSE AVAILABLE																			
Acetylene Dichloride (Dichloroethylene)	Colorless Liquid	1	X	X	X	-	X	X	-	X	1	-	X	1	X	-	-	-	-	-	X
Acetylene Tetrachloride (Tetrachloroethane)	Colorless Liquid	1	X	X	X	-	X	X	-	X	1	-	X	1	X	-	-	-	-	-	-
Acrolein (Hydroquinone Inhibited)	Colorless to Yellow Liquid	1	1	1	X	-	-	-	-	2	X	-	-	-	-	-	-	-	-	-	-
Acrylamide	Colorless Crystals	1	1	2	-	-	-	-	-	-	1	-	-	-	-	-	-	-	-	-	-
Acrylates (HEA or HPA)	Colorless Liquid	1	1	1	X	-	-	-	-	-	1	-	1	-	-	-	-	-	-	-	-
Acrylic Acid	Colorless Liquid	1	1	1	-	-	-	-	-	-	1	-	-	-	-	-	-	-	-	-	-
Acrylic Acid (Glacial 97%)	Colorless Liquid	1	1	1	X	X	X	X	X	X	1	X	X	X	X	-	-	-	-	-	-
Acrylic Emulsion	Liquid	1	1	1	X	-	-	-	-	-	1	-	-	-	-	-	-	-	-	-	-
Acrylonitrile	Colorless Liquid	1	2	2	X	X	2	2	X	X	X	X	1	-	1	1	1	1	-	-	-
Adipic Acid (70°F)	White Crystals	1	1	X	1	X	X	1	X	-	1	-	-	X	X	-	-	-	-	-	-
Aeroshell 7A, 17 Grease	Liquid	1	-	-	-	1	-	-	2	-	-	-	-	-	-	1	1	1	1	-	-
Air, 212°F (100°C)	Colorless Gas	1	1	2	1	1	2	X	1	1	1	1	1	X	2	1	1	1	1	1	-
Air, 257°F (125°C)	Colorless Gas	1	1	X	1	X	X	X	2	1	1	1	1	X	X	-	-	-	-	-	-
Air, 300°F (149°C)	Colorless Gas	1	1	X	1	X	X	X	X	1	1	X	X	X	X	-	-	-	-	-	-
Air, Ambient	Colorless Gas	1	1	1	1	1	1	1	1	1	1	1	1	1	1	1	1	1	1	1	1
Aircraft Hyd. Oil AA	Liquid	1	1	-	X	1	-	-	-	X	-	-	-	-	-	1	1	1	1	1	-
Alachlor (Lasso)	Colorless Crystals	1	1	-	-	-	-	1	-	-	-	-	-	-	-	-	1	1	-	-	-
Alkaline Liquid (NOS)	In Water Solutions	1	1	1	1	-	-	-	-	1	2	-	1	-	-	-	-	-	-	-	-
Alkaryl Polyether Alcohol	-	1	1	1	-	-	-	-	-	-	1	-	1	-	-	-	-	-	-	-	-
Alkyd Resin (Thermosetting Polymer)	Varies	1	1	-	-	-	-	-	-	-	-	-	-	-	-	-	-	-	-	-	-
Alkylaryl Sulfonate (Alkylbenzene Sulfonate)	Powder	1	1	1	-	1	-	1	-	-	1	X	1	-	-	1	1	-	-	-	-
Allomalaic Acid (Fumaric Acid) Solution	Liquid	1	1	-	2	1	2	2	-	-	1	-	-	-	X	-	1	1	-	-	-
Allyl Alcohol	Colorless Liquid	1	1	1	1	1	-	1	1	1	1	1	1	X	X	-	-	-	-	-	-
Allyl Bromide	Colorless to Yellow Liquid	1	-	-	-	-	-	-	-	-	-	-	-	-	-	-	-	-	-	-	-
Allyl Chloride	Colorless Liquid	1	1	X	X	X	X	X	X	X	1	-	2	1	X	-	1	1	-	-	2
Alpha Methylstyrene	Colorless Liquid	1	2	2	X	X	X	X	X	X	1	-	X	1	X	-	-	-	-	-	-
Alpha Olefin Sulfonate	Powder	-	-	-	-	-	-	1	-	-	-	-	-	-	-	-	-	-	-	-	-
Alpha Picoline	Colorless Liquid	1	1	-	-	-	-	-	-	-	-	-	-	-	-	-	-	-	-	-	-
Alum (Aluminum Sulphate or Other)	White Crystals	1	1	-	1	1	-	1	1	-	-	-	-	-	X	X	2	X	X	1	-
Alum, Potash (Aluminum Potassium Sulfate)	White Crystals	1	-	-	-	-	-	1	-	-	-	-	-	-	X	2	2	X	X	1	-
Alumina - Calcined (Conveyed Pneumatically)	Granular	-	-	-	-	-	-	1	-	-	-	-	-	-	-	-	-	-	-	-	-

TABLE OF CONTENTS

ABOUT GATES

HYDRAULIC HOSE

HYDRAULIC HOSE COUPLINGS

ENGINEERING AND TECHNICAL DATA

CHEMICAL RESISTANCE TABLE



TABLE OF CONTENTS

ABOUT GATES

HYDRAULIC HOSE

HYDRAULIC HOSE COUPLINGS

ENGINEERING AND TECHNICAL DATA

CHEMICAL	FORM (AT ROOM TEMPERATURE UNLESS OTHERWISE STATED)	GATES HOSE / POLYMERS														COUPLINGS						
		Teflon®	XLPE	UHMWPE	EPDM	NR	SBR	NR	CR	Butyl	Fluorocarbon	Hypalon®	CPE	Nylon	PVC	Iron/Carbon Steel	Stainless Steel 304	Stainless Steel 316	Aluminum	Brass	Polypro	
Alumina Trihydrate (Conveyed Pneumatically)	White Crystalline Powder	-	-	-	-	-	-	1	-	-	-	-	-	-	-	-	-	-	-	-	-	
Aluminum Acetate	White Powder	1	1	-	-	-	1	1	-	-	-	-	-	-	-	-	1	1	-	X	-	
Aluminum Alkyl (ie Triethylaluminum)	Colorless Liquid	X	X	X	X	X	X	X	X	X	1	X	X	X	X	-	-	-	-	-	-	
Aluminum Bromide	White to Yellow Crystals	1	1	-	1	1	1	1	1	1	1	1	1	-	-	-	X	2	2	-	X	-
Aluminum Chloride Solution	White to Yellow Solution	1	1	X	1	1	1	1	-	1	1	-	1	-	-	X	2	2	X	X	1	
Aluminum Chloride, Anhydrous	White to Yellow Crystals	-	-	-	-	-	-	1	-	-	-	-	-	-	-	-	-	-	-	-	-	
Aluminum Chlorohydrate Solution (Up to 50%)	White Solution	1	1	1	1	1	-	-	-	1	1	-	1	-	-	-	-	-	-	-	-	
Aluminum Fluoride	White Crystals	1	1	-	-	-	-	1	1	-	-	-	-	-	1	X	2	2	2	X	1	
Aluminum Formate (Di & Tri In Water)	In Hot Water	1	1	1	1	1	X	X	-	1	1	-	1	-	-	-	-	-	-	-	-	
Aluminum Hydroxide (Alumina Trihydrate)	In Mineral Acid or Caustic Soda	1	1	1	-	X	X	X	1	1	1	-	1	X	X	-	1	1	-	1	1	
Aluminum Nitrate	In Cold Water	1	1	1	1	1	1	1	1	1	1	1	1	-	1	X	1	1	2	-	1	
Aluminum Phosphate Solution	In HCl or HNO3 (slightly soluble)	1	1	1	-	X	X	X	X	-	1	-	X	X	-	-	-	-	-	-	-	
Aluminum Salts	Varies	1	1	-	1	1	1	1	1	1	-	1	-	-	1	-	2	2	2	-	1	
Aluminum Sulfate	White Crystals	1	1	-	1	1	-	1	1	-	-	-	-	-	X	X	2	X	X	1	1	
Aluminum Sulfate Solution	In Water	1	1	1	1	1	1	1	-	1	1	-	1	-	-	X	X	2	X	X	1	
Aluminum Sulfate Solution (49.7% H2O)	Liquid	1	1	1	1	1	1	1	1	1	1	-	1	1	1	X	X	2	X	X	1	
Amines (A class of Organic Compounds)	Varies	1	1	1	-	-	-	-	-	-	-	-	-	-	-	-	-	-	-	-	-	
Amines (Aromatic - IE P-Toluidine)	White Plates (Solid)	1	-	-	-	-	-	1	-	-	-	-	-	-	-	-	-	-	-	-	-	
Amines (Mixed)	Varies	1	2	-	2	2	2	2	2	2	X	-	-	-	-	-	1	-	X	X	-	
Amines (Primary, Secondary, Tertiary, Etc)	Varies	1	2	-	-	-	-	-	-	-	X	-	-	-	-	-	-	-	-	-	-	
Aminodiphenylamine	Purple Powder	1	2	-	-	-	-	-	-	-	-	-	-	-	-	-	-	-	-	-	-	
Aminoethanol (Ethanolamine)	Colorless Viscous Liquid	1	2	1	2	2	2	2	2	2	X	X	1	1	2	1	1	1	-	1	-	
Aminoethylethanolamine	Liquid	1	2	1	2	-	-	-	-	1	-	-	1	1	-	-	-	-	-	-	-	
Ammonia (Anhydrous)	Gas or liquid	NO HOSE AVAILABLE														-	-	-	-	-	-	
Ammonia (Aqueous up to 30% NH3)	Colorless Liquid	1	1	1	1	1	1	1	1	1	2	1	1	1	1	-	1	1	-	X	1	
Ammonia Liquor	Colorless Liquid	1	-	1	-	-	-	-	-	-	-	-	-	-	-	-	-	-	-	-	-	
Ammoniated Fatty Acid (ie Ammonium Caprylate)	Liquid above 167°F (75°C)	1	1	1	-	-	-	-	-	-	1	-	-	-	-	-	-	-	-	-	-	
Ammonium Acetate	In Water	1	1	1	1	1	1	1	2	1	1	-	1	2	1	-	1	1	-	X	1	
Ammonium Bicarbonate	White Crystals	1	-	-	-	-	-	1	-	-	-	-	-	-	1	-	-	-	-	-	1	
Ammonium Bisulfate (50%)	Colorless Liquid	1	1	1	1	-	-	-	-	1	1	-	1	-	-	-	-	-	-	-	-	
Ammonium Carbonate	Colorless to White Powder	1	1	-	-	X	-	1	2	-	-	-	-	-	1	1	1	1	-	-	1	
Ammonium Chloride	White Crystals	1	-	X	-	-	-	1	-	-	-	-	-	-	-	2	2	-	X	1		
Ammonium Chloride Solution	Liquid	1	1	-	1	2	1	1	X	1	-	1	X	1	-	2	2	-	X	1		
Ammonium Fluoride	White Crystals	-	-	-	-	-	-	1	-	-	-	-	-	-	-	-	-	-	-	-	-	
Ammonium Hydroxide (16%, 20%, 26%, & 30%)	Colorless Liquid	1	1	1	-	-	-	-	-	-	2	-	-	-	-	2	1	1	-	X	1	
Ammonium Hydroxide (up to 30% NH3)	Colorless Liquid	1	1	1	1	2	X	2	2	2	2	1	1	X	X	2	1	1	-	X	1	
Ammonium Metaphosphate	White powder	1	1	-	1	2	2	2	2	1	-	2	-	-	2	1	1	1	X	-	1	
Ammonium Nitrate	Colorless Crystals	1	1	-	-	-	-	1	-	-	-	-	-	-	-	1	1	1	2	X	1	
Ammonium Nitrate Fertilizer (20.5% N or 33.5% N)	Aggregate	1	-	-	-	-	-	1	-	-	-	-	-	-	-	1	1	1	2	X	1	
Ammonium Nitrate Prills and Oil	Aggregate	1	-	-	-	1	-	1	-	-	-	-	-	-	-	1	1	1	2	X	1	
Ammonium Nitrate Solution (up to 83%)	Liquid	1	1	1	1	1	-	1	1	-	1	1	1	1	-	1	1	1	2	X	1	
Ammonium Nitrite	Colorless crystal	1	1	-	-	X	X	X	2	-	-	-	1	-	-	-	1	1	-	-	1	
Ammonium Persulfate	Solution in Water	1	1	-	-	X	-	-	X	-	X	-	-	-	-	-	1	1	-	X	X	
Ammonium Phosphate	White Crystals or Powder	1	-	-	-	-	-	1	-	-	-	-	-	-	X	2	1	X	-	1		
Ammonium Phosphate Solutions	Liquid	1	1	1	1	1	1	1	1	1	1	1	1	-	1	X	2	1	X	-	1	
Ammonium Polysulfide Solution	Yellow Solution	1	1	1	-	-	-	-	-	-	-	-	-	-	-	-	-	-	-	-	-	
Ammonium Sulfate	Gray to White Crystals	1	1	-	-	-	-	1	-	-	-	-	1	-	-	1	1	1	X	X	1	
Ammonium Sulfide	Yellow Crystals	1	1	-	-	-	-	1	-	-	-	-	-	-	-	1	1	1	X	X	1	
Ammonium Sulfide Solution (40-44% or less)	Liquid	1	1	-	1	2	1	1	-	1	1	1	1	-	1	1	1	X	X	1	1	
Ammonium Thiocyanate (50-60% or less)	In Water	1	1	1	1	1	1	1	1	-	1	1	1	-	-	1	1	1	-	-	1	
Amyl Acetate (Banana or Pearl Oil)	Colorless Liquid	1	1	1	2	X	X	X	X	2	X	X	X	1	X	X	1	1	X	1	X	
Amyl Alcohol	Colorless Liquid	1	2	2	2	2	2	2	2	2	1	2	1	1	2	1	1	1	1	1	-	

CHEMICAL RESISTANCE TABLE



CHEMICAL	FORM (AT ROOM TEMPERATURE UNLESS OTHERWISE STATED)	GATES HOSE / POLYMERS														COUPLINGS						
		Teflon®	XLPE	UHMWPE	EPDM	NR	SBR	NR	CR	Butyl	Fluorocarbon	Hypalon®	CPE	Nylon	PVC	Iron/Carbon Steel	Stainless Steel 304	Stainless Steel 316	Aluminum	Brass	Polypro	
		1	2	2	X	X	X	X	X	X	1	X	2	1	X	-	1	1	-	1	1	-
Amyl Chloride (Chloropentane)	Colorless Liquid	1	2	2	X	X	X	X	X	X	1	X	2	1	X	-	1	1	-	1	-	X
Amyl Chlorides (mixed)	Straw to Purple Liquid	1	2	2	X	X	X	X	X	X	1	X	2	1	X	-	1	1	-	1	-	X
Amyl Chloronaphthalene	-	1	1	2	X	X	X	X	X	X	1	X	X	1	-	1	1	-	1	-	-	
Amyl Naphthalene	-	1	1	-	X	X	X	X	X	X	1	X	X	-	-	1	1	-	1	-	-	
Amyl Phenol	Clear Straw Colored Liquid	1	2	-	-	-	-	-	-	-	-	-	-	-	-	1	1	-	1	-	-	
Amylamine	Colorless Liquid	1	X	-	X	2	-	X	X	X	X	-	-	-	-	-	-	-	-	-	-	
Amylbenzene (sec amylbenzene)	Clear Liquid	1	2	2	X	2	X	X	2	X	1	-	-	-	-	-	-	-	-	-	-	
Anethole (anise camphor)	White Crystals/Liquid > 73°F(23°C)	1	2	-	-	X	X	X	X	X	1	X	X	X	-	2	1	1	2	X	1	
Anhydrous Ammonia (R 717)	Gas or Liquid	NO HOSE AVAILABLE														-	-	-	-	-	-	
Aniline	Colorless Oily Liquid	1	2	X	2	X	X	X	X	2	1	X	2	X	-	2	1	1	2	X	1	
Aniline Dyes	-	1	1	-	2	X	X	X	X	2	2	X	2	-	-	X	1	1	-	-	2	
Aniline Hydrochloride	White Crystals	1	1	-	2	2	2	2	X	2	-	-	-	-	-	X	X	-	X	2	-	
Aniline Oil (Aniline)	Colorless Oily Liquid	1	2	X	2	X	X	X	X	2	1	X	2	X	-	2	1	1	2	X	1	
Animal Fat (Lard)	White Solid/Liquid > 108°F(42°C)	1	1	1	X	1	X	X	2	X	1	X	1	1	-	1	1	1	1	X	-	
Animal Gelatin	-	1	-	1	-	1	-	-	-	1	-	-	-	-	1	-	1	1	-	-	-	
Animal Grease, Inedible, Liquid	Liquid	1	-	-	X	1	-	X	2	X	1	2	-	-	-	-	-	-	-	-	-	
Animal Oils	Solid to Liquid	1	-	-	-	1	-	-	2	-	-	-	1	1	1	1	1	1	1	-	-	
Ant Oil (Furfural)	Colorless to Reddish Brown Liquid	1	1	-	X	X	X	X	2	X	2	2	1	-	X	2	1	1	1	1	2	
Antifreeze (Glycol Base)	Liquid	1	1	2	1	1	1	1	1	1	1	1	1	1	1	1	1	1	1	1	1	
Antimony Chloride (50%)	White Powder	1	1	1	-	-	-	-	-	2	1	-	-	1	1	X	X	X	-	-	1	
Antimony Pentachloride	Reddish-yellow Liquid	1	1	1	-	-	-	-	-	-	1	-	-	-	-	-	-	-	-	-	-	
Antimony Salts	White Crystal	1	1	-	1	2	-	-	-	1	1	-	-	-	1	-	-	-	-	-	-	
Aqua Ammonia (Ammonium Hydroxide) (30%)	Colorless Liquid	1	1	1	1	2	2	2	2	2	2	1	1	X	X	2	1	1	-	X	1	
Aqua Regia (Nitrohydrochloric Acid)	Fuming Yellow Liquid	1	2	X	X	X	X	X	X	X	1	X	2	X	X	-	X	X	-	-	X	
Argon, Compressed	Colorless Gas	1	1	1	1	1	1	1	1	1	1	1	1	1	1	-	-	-	-	-	-	
Aromatic Hydrocarbons	Typically Colorless Liquids	1	2	2	X	2	X	X	X	X	1	X	X	1	X	1	1	1	2	2	-	
Arsenic Acid	In Water	1	1	1	2	-	X	X	-	2	1	-	1	-	2	-	1	2	-	2	-	
Arsenic Trioxide	In Acid	1	1	1	X	2	X	X	2	X	1	X	-	-	1	-	-	-	-	-	-	
Askarel (Transformer Oil)	Varies	1	2	2	X	X	X	X	X	X	1	X	1	1	X	1	1	1	-	1	2	
Asphalt	Varies	1	2	X	X	2	X	X	-	X	1	-	-	X	X	1	1	1	-	1	-	
Asphalt (Blown)	Black Solid	-	-	X	-	-	-	1	-	-	-	-	-	-	-	-	-	-	-	-	-	
Asphalt (Cut Back)	Black Liquid	1	X	X	X	2	X	X	2	X	1	X	X	2	X	1	1	1	-	1	-	
Asphalt Emulsion	Black Liquid	-	-	X	-	-	-	-	-	-	-	-	-	-	-	-	-	-	-	-	-	
Asphalt Paint	Black Liquid	1	2	X	X	2	X	X	-	X	1	X	-	2	X	-	-	-	-	-	-	
Asphaltene	In Carbon Disulfide	1	2	X	X	2	X	X	2	X	1	X	X	1	-	-	-	-	-	-	-	
ASTM Oil No. 1	Brown Liquid	1	1	1	X	1	X	X	1	X	1	2	1	1	2	1	1	1	1	1	2	
ASTM Oil No. 2	Brown Liquid	1	1	1	X	1	X	X	2	X	1	2	1	1	X	1	1	1	1	1	X	
ASTM Oil No. 3	Brown Liquid	1	1	1	X	1	X	X	X	X	1	X	1	1	X	1	1	1	1	1	X	
ASTM Reference Fuel A	Liquid	1	1	1	X	1	X	X	1	X	1	1	1	1	2	1	1	1	1	1	X	
ASTM Reference Fuel B	Liquid	1	2	1	X	1	X	X	2	X	1	X	2	1	X	1	1	1	1	1	X	
ASTM Reference Fuel C	Liquid	1	2	2	X	2	X	X	X	X	1	X	2	1	X	1	1	1	-	1	X	
ATF (Automatic Transmission Oil)	Liquid	1	1	1	X	1	-	-	-	X	1	-	1	-	-	-	-	-	-	-	-	
B																						
Baltic Types 100, 150, 200, 300, 500	Liquid	1	1	-	X	1	-	-	-	X	-	-	-	-	2	-	-	-	-	-	2	
Banvel (Ag Spray, Concentrated)	Liquid	1	1	-	-	-	-	-	-	-	-	-	1	-	-	-	1	-	-	-	-	
Bardol B	Dark colored Liquid	1	1	-	X	X	X	X	X	X	2	X	-	-	-	1	1	1	-	-	-	
Barite (Natural Barium Sulfate)	White to Yellowish Powder	-	-	-	-	-	-	1	-	-	-	-	-	-	-	1	1	1	-	2	1	
Barium Carbonate	White Powder	1	1	-	X	1	X	1	1	X	1	X	X	-	1	2	1	1	-	1	1	
Barium Chloride	Colorless Crystals	1	1	1	1	1	1	1	1	1	1	1	1	X	1	X	1	1	-	2	1	
Barium Hydroxide	White Powder	1	1	1	1	1	X	1	1	1	-	1	1	-	X	2	1	1	-	-	1	
Barium Sulfate	White to Yellowish Powder	-	-	-	-	-	-	1	-	-	-	-	-	-	-	1	1	1	-	2	1	
Barium Sulfide	Yellowish Green to Gray Powder	1	1	1	-	-	-	1	-	-	1	-	-	-	-	X	1	1	-	X	1	

TABLE OF CONTENTS

ABOUT GATES

HYDRAULIC HOSE

HYDRAULIC HOSE COUPLINGS

ENGINEERING AND TECHNICAL DATA

CHEMICAL RESISTANCE TABLE



TABLE OF CONTENTS

ABOUT GATES

HYDRAULIC HOSE

HYDRAULIC HOSE COUPLINGS

ENGINEERING AND TECHNICAL DATA

CHEMICAL	FORM (AT ROOM TEMPERATURE UNLESS OTHERWISE STATED)	GATES HOSE / POLYMERS															COUPLINGS					
		Teflon®	XLPE	UHMWPE	EPDM	NR	SBR	NR	CR	Butyl	Fluorocarbon	Hypalon®	CPE	Nylon	PVC	Iron/Carbon Steel	Stainless Steel 304	Stainless Steel 316	Aluminum	Brass	Polypro	
Basic Copper Arsenate	Blue to Green Powder	1	1	-	-	-	2	1	-	-	1	2	-	-	1	1	1	1	-	-	-	
BBP (Butyl Benzyl Phthalate)	Clear Oily Liquid	1	-	-	-	X	-	X	-	1	X	X	-	-	-	-	-	-	-	-	-	
Beer	Yellow Liquid	-	-	-	-	-	-	-	-	-	-	-	-	-	-	-	-	-	-	-	-	
Beet Sugar Liquors	Colorless Solution	1	1	1	1	1	1	1	1	1	1	1	1	1	1	X	X	X	X	-	X	
Bellows 80-20 Hydraulic Oil	Liquid	1	1	-	X	1	-	-	-	X	-	-	-	-	2	-	-	-	-	-	X	
Benzaldehyde (Benzoic Aldehyde)	Colorless to Yellow Liquid	1	1	1	2	X	X	X	X	2	X	X	2	2	X	1	-	-	1	-	1	
Benzene (Benzol)	Colorless to Yellow Liquid	1	2	X	X	X	X	X	X	X	1	X	X	1	X	1	1	1	1	1	X	
Benzenesulfonic Acid	Liquid above 151°F (66°C)	1	1	1	-	-	X	X	X	2	1	2	-	-	X	X	-	2	X	-	1	
Benzidine	Paste	1	2	-	X	2	X	1	X	X	-	-	-	-	X	1	1	1	1	1	X	
Benzoic Acid	White Crystals	1	1	1	2	X	X	X	X	2	1	2	1	-	X	-	-	-	-	-	-	
Benzoic Aldehyde (Benzaldehyde)	Colorless to Yellow Liquid	1	1	1	2	X	X	X	X	2	X	X	2	2	X	1	-	-	1	-	1	
Benzol (Benzene)	Colorless to Yellow Liquid	1	2	X	X	X	X	X	X	X	1	X	X	1	X	1	1	1	1	1	X	
Benzophenone	White Powder	1	1	-	-	-	-	1	-	-	1	-	-	-	-	-	-	-	-	-	-	
Benzotrichloride	Colorless to Yellow Liquid	1	-	-	X	X	X	X	X	X	1	-	X	2	X	-	-	-	-	-	-	
Benzyl Acetate	Water White Liquid	1	2	2	-	-	-	-	-	-	-	-	-	-	-	-	-	-	-	-	-	
Benzyl Alcohol	Water White Liquid	1	1	1	2	X	X	X	X	1	1	X	1	X	1	-	-	-	-	-	-	
Benzyl Alcohol, Photo Inhibited	Water White Liquid	1	-	-	-	-	-	-	-	-	-	-	-	-	-	1	1	1	-	-	1	
Benzyl Benzoate	Water White Liquid	1	1	-	2	-	-	-	-	2	1	-	-	-	-	1	1	1	-	-	-	
Benzyl Chloride	Colorless Liquid	1	2	2	X	X	X	X	X	X	1	-	X	2	X	1	-	-	-	-	-	
Bicarbonate Of Soda	White Powder	-	-	-	-	-	-	1	-	-	-	-	-	-	-	-	-	-	-	-	-	
Bismuth Carbonate	White Powder	1	-	-	-	-	-	1	X	-	-	-	-	-	-	1	1	1	-	-	1	
Bisphenol A	White Flakes	-	-	-	-	-	-	1	-	-	-	-	-	-	-	-	-	-	-	-	-	
Bitumastic	Liquid	1	-	X	X	2	X	X	2	X	2	X	2	-	-	1	1	1	-	1	-	
Black Liquor (RXN Product Pulpwood+NaOH)	Black Alkaline Liquid	1	1	1	2	2	X	X	2	2	1	2	2	-	1	1	1	1	-	-	1	
Black Sulfate Liquor (See "Black Liquor")	Black Alkaline Liquid	1	1	1	2	2	X	X	2	2	1	2	2	-	1	1	1	1	-	-	1	
Blast Furnace Gas (Cooled)	Gas	1	1	-	-	X	X	X	X	X	1	X	-	-	X	1	1	1	-	1	-	
Bleach (Chlorinated Lime)	White Powder (35-37% Cl)	-	-	-	-	-	-	1	-	-	-	-	-	-	-	-	-	-	-	-	-	
Bleach Liquor (Calcium Hypochlorite/H2O)	Clear Solution	1	1	1	2	-	-	-	-	-	1	-	1	-	-	-	-	-	-	-	-	
Borax (Sodium Borate)	White Crystals	1	1	-	1	1	1	1	1	1	1	1	1	1	1	2	1	1	-	2	1	
Bordeaux Mixture (Slaked Lime & Copper Sulfate)	In Water	1	1	1	1	1	1	1	1	1	1	1	-	-	-	1	-	1	1	-	-	
Boric Acid	White Powder or Colorless Scale	1	1	1	1	1	1	1	1	1	1	1	1	X	1	X	2	1	1	X	1	
Boric Oxide	Colorless Powder	1	-	-	-	-	-	1	-	-	-	-	-	-	1	-	-	-	-	-	-	
Brake Fluid (Petroleum Base)	Liquid	1	1	-	X	1	X	X	2	X	1	X	1	1	2	1	1	1	-	1	X	
Brake Fluid (Synthetic Base)	Liquid	1	1	-	1	X	X	X	X	1	X	X	1	-	2	1	1	1	-	1	-	
Brine (Salt)	Liquid	1	1	1	1	1	1	1	1	1	1	1	1	1	1	2	1	1	-	2	1	
Bromine	Dark Reddish Brown Liquid	1	-	-	X	X	-	-	X	-	1	-	-	X	X	1	1	1	1	1	-	
Bromobenzene	Colorless Liquid	1	-	-	X	-	X	X	-	X	1	-	-	-	X	-	-	-	-	-	-	
Bromochloroethane	Colorless Liquid	-	-	X	X	-	X	X	-	X	X	-	X	X	-	-	-	-	-	-	-	
Bromochloromethane (Chlorobromomethane)	Clear Liquid	1	2	X	X	X	X	X	X	X	X	X	X	X	1	1	1	-	1	X	-	
Bromotoluene	Clear Liquid	1	-	-	X	-	X	X	-	X	1	-	X	-	X	-	-	-	-	-	-	
Bubble Bath Compounds	Liquid	1	-	1	-	-	-	-	-	-	-	-	-	-	-	-	-	-	-	-	-	
Bunker Oil	Liquid	1	2	2	X	1	X	X	2	X	1	X	-	1	X	1	1	1	1	1	-	
Butadiene (1,3)	Gas	1	1	-	X	2	X	X	X	X	1	X	-	1	X	-	1	1	-	1	1	
Butanal (Butyraldehyde)	Water White Liquid	1	2	-	X	X	X	X	X	X	X	2	-	-	-	-	-	-	-	1	-	
Butandiol (Butylene Glycol)	Colorless Oily Liquid	1	1	2	-	-	-	-	-	-	1	-	-	X	-	-	-	-	-	-	-	
Butane (Gas)	Colorless Gas	USE LPG HOSE ONLY															-	-	-	-	-	-
Butane (Liquid)	Liquid	USE LPG HOSE ONLY															-	-	-	-	-	-
Butanol (Butyl Alcohol)	Colorless Liquid	1	1	1	1	1	1	1	2	1	2	1	1	1	1	1	1	1	1	1	1	
Butter	Yellow to white semi-Solid to Liquid	-	-	-	-	-	-	-	-	-	-	-	2	-	-	-	-	-	-	-	-	
Butter Oil (Use FDA Hose)	Yellow to white Liquid	1	-	-	-	-	X	X	2	-	-	-	-	-	-	1	1	1	1	1	-	
Butyric Acid	Colorless Liquid	1	1	1	2	-	2	2	X	2	1	X	1	X	-	-	-	-	-	-	-	
Butyl Carbitol (Diethylene Glycol Butyl Ether)	Colorless Liquid	1	1	-	2	2	X	X	2	2	1	-	1	-	-	1	1	1	1	1	-	

CHEMICAL RESISTANCE TABLE



CHEMICAL	FORM (AT ROOM TEMPERATURE UNLESS OTHERWISE STATED)	GATES HOSE / POLYMERS														COUPLINGS					
		Teflon®	XLPE	UHMWPE	EPDM	NR	SBR	NR	CR	Butyl	Fluorocarbon	Hypalon®	CPE	Nylon	PVC	Iron/Carbon Steel	Stainless Steel 304	Stainless Steel 316	Aluminum	Brass	Polypro
Butyl Cellosolve (EG Monobutyl Ether)	Colorless Liquid	1	1	-	1	-	-	-	-	-	-	1	-	1	-	-	-	-	-	-	-
Butyl "Oxito™" for EG Monobutyl Ether	Colorless Liquid	1	1	-	1	-	-	-	-	-	-	1	-	1	-	-	-	-	-	-	-
Butyl Acetate	Colorless Liquid	1	2	2	X	X	X	X	X	2	X	X	2	1	1	2	1	1	1	1	X
Butyl Acrylate	Colorless Liquid	1	-	-	-	-	-	-	-	-	X	-	-	-	-	-	-	-	-	-	-
Butyl Alcohol (Butanol)	Colorless Liquid	1	1	1	1	1	1	1	2	1	1	2	1	1	1	1	1	1	1	1	1
Butyl Aldehyde	Water White Liquid	1	-	-	2	X	-	-	X	-	X	X	-	-	-	-	-	-	-	-	-
Butyl Benzyl Phthalate (BBP)	Clear Oily Liquid	1	-	-	-	X	-	X	-	1	X	X	-	-	-	-	-	-	-	-	-
Butyl Chloride	Colorless Liquid	1	-	-	-	-	-	-	-	-	1	-	-	-	-	-	-	-	-	-	-
Butyl Ether	Colorless Liquid	1	1	-	-	2	X	X	2	2	X	-	1	-	-	1	1	1	1	1	-
Butyl Ethyl Ether (Ethyl-n-Butyl Ether)	Liquid	1	-	-	-	2	-	X	-	X	-	2	-	-	-	-	-	-	-	-	-
Butyl Formate	Colorless Liquid	1	-	-	-	X	-	X	X	-	-	-	-	-	-	-	-	-	-	-	-
Butyl Mercaptan (2-Methyl-2-Butanathiol)	Liquid	1	1	-	X	-	X	X	-	X	1	-	-	-	X	-	1	1	-	-	-
Butyl Methacrylate	Colorless Liquid	1	-	-	-	-	-	-	-	-	-	-	-	-	-	-	-	-	-	-	-
Butyl Stearate	Colorless Liquid	1	1	-	X	2	X	X	X	X	1	-	2	-	1	1	1	1	1	1	-
Butylamine	Colorless Liquid	1	1	-	-	X	X	X	X	X	X	2	-	-	1	1	1	1	1	1	X
Butylene Glycol (Butandiol)	Colorless Oily Liquid	1	1	2	-	-	-	-	-	-	1	-	-	X	-	-	-	-	-	-	-
Butyraldehyde (Butanal)	Water White Liquid	1	2	-	X	X	X	X	X	X	X	2	-	-	-	-	-	-	-	1	-
Butyric Acid	Colorless Liquid	1	1	1	1	-	-	-	-	1	1	X	1	1	1	X	1	1	1	2	-
Butyric Anhydride	Water White Liquid	1	-	-	-	-	-	-	-	-	-	-	-	-	-	-	-	-	-	-	-
C																					
Cadmium Acetate (Soluble in H2O & Alcohols)	In Water or Alcohol	1	-	-	-	X	-	X	-	1	X	-	-	-	-	-	-	-	-	-	-
Cake Alum (Aluminum Sulfate)	White Crystals	1	1	-	1	1	-	1	1	-	-	-	-	-	X	X	2	X	X	1	-
Cake Alum Solution (Al Sulphate up to 50%)	In Water	1	1	1	1	1	-	-	-	1	1	-	1	1	1	-	-	-	-	-	-
Calcine Liquor (Radioactive Waste)	In Water Solution	1	1	-	1	1	-	-	-	1	1	-	-	-	-	1	1	1	2	-	-
Calcium Acetate	Powder	1	1	-	1	X	2	2	X	1	X	X	1	-	-	1	1	1	1	1	-
Calcium Aluminate (Soluble in Acids)	In Acid	1	-	-	-	1	-	1	1	1	1	1	-	-	-	-	-	-	-	-	-
Calcium Aluminate (Tricalcium Aluminate)	Crystals or Powder	1	-	-	-	-	-	1	-	-	-	-	-	-	-	-	-	-	-	-	-
Calcium Arsenate	In Dilute Acid	1	1	-	-	-	-	-	-	-	1	-	-	-	1	-	-	-	-	-	-
Calcium Bisulfide (Calcium Hydrosulfide)	In Alcohol or Water	1	1	-	-	1	2	2	1	1	1	1	1	-	2	-	2	1	-	X	1
Calcium Bisulfite (Calcium Hydrogen Sulfite)	Yellow Liquid	1	1	-	-	1	2	2	1	1	1	1	1	-	1	-	1	1	-	-	1
Calcium Bromide Solution	In Water or Alcohol	1	1	1	-	-	-	-	-	-	1	-	-	-	-	-	-	-	-	-	-
Calcium Carbonate	Solid White Powder	1	1	-	1	1	1	1	1	1	1	1	1	1	1	1	1	1	1	1	1
Calcium Carbonate Slurry	Solid in H2O	1	-	-	1	1	1	1	1	1	1	1	-	-	-	-	-	-	-	-	-
Calcium Chlorate	In Water or Alcohol	1	1	-	2	1	2	2	1	2	-	1	-	1	-	2	1	-	-	-	1
Calcium Chloride, Dry	White solid	-	-	-	-	-	-	-	-	-	-	-	-	-	X	2	1	-	2	1	-
Calcium Chloride, Liquid (Not For Food)	In Water or Alcohol	1	1	-	1	1	1	1	1	1	1	1	1	X	1	-	-	-	-	-	-
Calcium Chloride, Liquid, Food Grade 33%	In Water	1	-	-	1	1	1	1	1	1	1	1	1	1	1	-	-	-	-	-	-
Calcium Hydrogen Sulfite (Calcium Bisulfite)	Yellow Liquid	1	1	-	-	1	2	2	1	1	1	1	1	-	1	-	1	1	-	-	1
Calcium Hydrosulfide (Calcium Bisulfide)	In Alcohol or Water	1	1	-	-	1	2	2	1	1	1	1	1	-	2	-	2	1	-	X	1
Calcium Hydroxide (Hydrated or Slaked Lime)	Solid White Powder	1	1	-	-	2	1	1	1	1	X	1	1	-	X	X	X	1	-	2	1
Calcium Hydroxide Solutions	In Glycerol or Acids	1	1	X	-	2	-	-	-	-	-	-	-	X	-	2	1	1	X	X	-
Calcium Hypochlorite	Solid White Crystals	1	2	X	-	-	X	X	X	2	-	2	1	X	2	-	-	-	-	-	-
Calcium Hypochlorite Solutions	In Water or Alcohol	1	1	X	-	-	X	X	X	2	-	2	1	-	1	-	X	2	X	X	1
Calcium Metasilicate (Calcium Silicate)	White Powder	1	1	-	-	2	2	1	-	2	1	2	1	-	1	1	1	1	1	1	-
Calcium Nitrate Solutions	In Water, Alcohol, or Acetone	1	1	-	1	1	1	1	1	1	1	1	1	-	1	1	1	1	1	1	1
Calcium Oxide (Lime; quick, unslaked)	White to Gray Lumps	-	-	-	-	-	-	1	-	-	-	-	-	-	-	-	-	2	-	-	-
Calcium Silicate (Calcium Metasilicate)	White Powder	1	1	-	-	2	2	1	-	2	1	2	1	-	1	1	1	1	1	1	-
Calcium Stearate	White Powder	-	-	-	-	-	-	1	-	-	-	-	-	-	-	-	-	-	-	-	-
Calcium Sulfate	White Powder or Crystals	1	1	-	1	1	-	1	1	1	1	1	1	-	-	1	1	1	-	1	1
Calcium Sulfide	Yellow to Gray Powder	1	1	-	-	1	2	1	2	1	2	1	1	-	2	1	1	1	2	-	-
Calcium Sulfite (Soluble In Sulfurous Acid)	In Acid	1	1	1	1	-	-	-	-	X	1	-	1	-	-	-	-	-	-	-	-
Caliche Liquors (Sodium Nitrate)	In Water	1	1	-	-	1	2	2	-	1	-	1	-	-	-	1	1	-	-	-	-

TABLE OF CONTENTS

ABOUT GATES

HYDRAULIC HOSE

HYDRAULIC HOSE COUPLINGS

ENGINEERING AND TECHNICAL DATA

CHEMICAL RESISTANCE TABLE



TABLE OF CONTENTS

ABOUT GATES

HYDRAULIC HOSE

HYDRAULIC HOSE COUPLINGS

ENGINEERING AND TECHNICAL DATA

CHEMICAL	FORM (AT ROOM TEMPERATURE UNLESS OTHERWISE STATED)	GATES HOSE / POLYMERS													COUPLINGS							
		Teflon®	XLPE	UHMWPE	EPDM	NR	SBR	NR	CR	Butyl	Fluorocarbon	Hypalon®	CPE	Nylon	PVC	Iron/Carbon Steel	Stainless Steel 304	Stainless Steel 316	Aluminum	Brass	Polypro	
Ferric Sulfate	Yellow Crystals or Gray Powder	-	-	-	-	-	-	1	-	-	-	-	-	-	-	X	1	1	X	X	1	
Ferric Sulfate Solution	Liquid	1	1	1	2	2	2	-	2	2	1	2	1	-	1	X	1	1	X	X	1	
Ferrous Acetate Solution	Liquid in H2O or Alcohol	1	1	-	-	-	-	-	-	-	1	-	-	-	-	-	-	-	-	-	-	
Ferrous Chloride	Greenish-White Crystals	-	-	-	-	-	-	1	-	-	-	-	-	-	X	1	2	-	2	1		
Ferrous Chloride, Solution	Liquid	1	1	-	-	-	-	-	-	1	1	2	1	-	1	X	1	2	-	2	1	
Ferrous Nitrate	-	1	1	-	2	2	-	-	2	2	-	2	-	-	2	-	1	1	-	-	1	
Ferrous Sulfate Solution	Liquid	1	1	1	2	2	2	-	2	2	1	2	1	-	1	X	1	1	X	X	1	
Fertilizer (Liquid Manure)	Liquid	1	1	1	1	1	1	1	1	1	1	1	1	-	1	2	1	1	1	1	1	
Finishing Oil	Liquid	1	-	1	-	-	-	-	-	-	-	-	-	-	-	-	-	-	-	-	-	
Fire-Resistance Hydra-Fluid (Texaco)	Liquid	1	1	-	X	1	-	-	-	X	-	-	-	-	-	1	1	1	1	1	-	
Firtec 290, MF	Liquid	1	1	-	-	-	-	-	-	-	-	-	-	-	-	-	-	-	-	-	-	
Fish Oil	Liquid	1	-	1	X	1	-	-	2	-	1	-	-	-	-	-	-	-	-	-	-	
Fixing Solution (Photo)	Liquid	1	1	-	-	-	2	2	2	2	-	2	-	1	1	-	1	1	-	-	1	
Flint	Gray, Brownish, Black	-	-	-	-	-	-	1	-	-	-	-	-	-	-	-	-	-	-	-	-	
Floor Wax (Temperature Dependent)	Varies	1	-	1	-	-	-	-	-	-	-	-	-	-	-	-	-	-	-	-	-	
Fluoboric Acid (48% Purity)	Colorless Liquid	1	1	1	2	-	2	2	2	-	-	2	1	-	X	-	1	1	-	-	1	
Fluoboric Acid (up to 48%)	Colorless Liquid	1	1	-	1	-	2	2	2	-	1	2	1	-	X	-	1	1	-	-	1	
Fluorine	Pale Yellow Gas	X	-	X	X	-	-	-	-	-	1	-	-	X	1	-	-	-	-	-	-	
Fluorine (Liquid)	Yellow Liquid	NO HOSE AVAILABLE															-	-	-	-	-	
Fluosilicic Acid (50%)	Colorless Liquid	1	1	1	2	X	-	-	2	X	-	2	1	X	X	-	-	-	1	-	1	
Formaldehyde	Gas	-	1	-	1	-	-	-	-	-	1	-	-	1	-	X	2	1	2	1	-	
Formaldehyde Solution (up to 50%)	Liquid	1	2	1	1	2	X	X	2	2	1	2	1	1	1	X	2	1	2	1	-	
Formalin (37-50% HCHO with 15% MeOH)	Liquid	1	1	-	1	2	X	X	2	2	1	2	1	1	1	-	-	-	-	-	-	
Formamide	Colorless Oily Liquid	1	1	-	-	-	X	X	-	-	-	-	-	X	-	-	-	-	-	-	-	
Formic Acid	Colorless Liquid (bp 100°C)	1	1	1	2	-	X	X	1	2	X	2	1	X	X	X	2	1	-	2	1	
FR Fluid D	Liquid	1	1	-	X	1	-	-	-	X	-	-	-	-	-	-	-	-	-	-	-	
FR Hydraulic Fluid	Brown Liquid	1	1	-	-	1	-	-	-	-	-	-	-	-	-	-	-	-	-	-	-	
Freon 12 (Dichlorodifluoromethane)	Gas or Liquid	SPECIAL HOSE REQUIRED															-	-	-	-	-	-
Freon 13	Gas or Liquid	SPECIAL HOSE REQUIRED															-	-	-	-	-	-
Freon 134a (HFC 134a)	Gas or Liquid	SPECIAL HOSE REQUIRED															-	-	-	-	-	-
Freon 22 (Chlorodifluoromethane)	Gas or Liquid	SPECIAL HOSE REQUIRED															-	-	-	-	-	-
Freon 23	Clear Liquid	SPECIAL HOSE REQUIRED															-	-	-	-	-	-
Fruit Juices	Liquid	-	-	-	-	-	-	-	-	-	-	-	-	1	-	-	-	-	-	-	-	
Fuel Oil (ASTM 1-6)	Water White to Brown Liquids	1	2	1	X	1	X	X	2	X	1	X	1	1	X	2	2	2	1	1	-	
Fumaric Acid	Colorless Crystals	1	1	1	2	-	2	2	-	-	1	-	-	-	X	-	1	1	-	-	-	
Fumaric Acid Solution (Allomalaic Acid)	Liquid	1	1	-	2	1	2	2	-	-	1	-	-	-	X	-	1	1	-	-	-	
Furan (Furfuran)	Colorless to Brown Liquid	1	1	1	X	X	X	X	X	X	X	-	-	1	-	X	1	1	1	1	1	
Furfural (Ant Oil)	Colorless to Reddish Brown Liquid	1	1	-	X	X	X	X	2	X	2	2	1	-	X	2	1	1	1	1	2	
Furfural Alcohol	Colorless to Brown Liquid	1	1	2	X	X	X	X	2	X	1	2	1	1	X	2	1	1	1	1	2	
Furfuran (Furan)	Colorless to Brown Liquid	1	1	1	X	X	X	X	X	X	-	-	1	-	X	1	1	1	1	1	1	
Furfuryl Alcohol	Colorless to Reddish Brown Liquid	1	1	-	-	-	-	-	-	-	1	-	-	-	1	-	-	-	-	-	-	
Fusel Oil (Amyl Alcohol, Grain Oil)	Colorless Liquid	1	1	1	2	2	2	2	2	2	1	2	1	1	1	1	1	1	1	1	-	
Fyrguard 150, 200	-	1	1	-	1	1	-	-	-	1	-	-	-	-	-	1	1	1	1	1	-	
Fyrquel 15R&O, 220R&O, 550R&O	-	1	1	-	1	X	-	-	-	1	-	-	-	-	-	1	-	-	1	-	-	
Fyrquel 90, 150, 220, 300, 550, 1000	-	1	1	-	1	X	-	-	-	1	-	-	-	-	-	1	-	-	1	-	-	
G																						
Gallic Acid (3,4,5 Trihydroxybenzoic Acid)	In Alcohol or Glycerol	1	1	1	1	X	2	2	X	2	1	-	-	1	X	X	X	1	1	-	1	
Gallic Acid Solution	In Alcohol Solution	1	1	-	-	X	2	2	X	2	1	-	-	1	X	X	X	1	1	-	1	
Gasohol (Gasoline blended with Ethanol) ¹	Colorless Liquid	1	2	1	X	2	X	X	2	X	1	X	-	1	X	2	1	1	1	1	X	
Gasoline (Oxygenated - Blended With MTBE) ¹	Colorless Liquid	1	2	1	X	2	X	X	2	X	1	X	-	1	X	2	1	1	1	1	X	
Gasoline (Unleaded Up to 50% Aromatics) ¹	Colorless Liquid	1	2	1	X	2	X	X	2	X	1	X	1	1	X	2	1	1	1	1	-	
Gasoline (White) ¹	Colorless Liquid	1	2	-	X	2	X	X	2	X	1	X	-	1	X	2	1	1	1	1	-	

CHEMICAL RESISTANCE TABLE



TABLE OF CONTENTS

ABOUT GATES

HYDRAULIC HOSE

HYDRAULIC HOSE COUPLINGS

ENGINEERING AND TECHNICAL DATA

CHEMICAL	FORM (AT ROOM TEMPERATURE UNLESS OTHERWISE STATED)	GATES HOSE / POLYMERS														COUPLINGS					
		Teflon®	XLPE	UHMWPE	EPDM	NR	SBR	NR	CR	Butyl	Fluorocarbon	Hypalon®	CPE	Nylon	PVC	Iron/Carbon Steel	Stainless Steel 304	Stainless Steel 316	Aluminum	Brass	Polypro
Houghto-Safe 5046	Liquid	1	1	-	X	1	-	-	-	X	-	-	-	-	1	1	1	1	1	1	-
Houghto-Safe 625, 640 & 525 Under 100°F (38°C)	Liquid	1	1	-	1	1	-	-	-	1	-	-	-	-	1	1	1	1	1	1	-
HPA Acid (2-Hydroxypropyl Acrylate)	Liquid	1	1	1	X	-	-	-	-	1	-	1	-	-	-	-	-	-	-	-	-
HPO (Sodium Thiosulfate)	White Powder	1	1	-	-	1	1	1	1	1	-	1	1	1	X	1	1	2	X	-	-
Hy-Chock Oil	Liquid	1	1	-	-	1	-	-	-	1	-	-	1	-	1	1	1	-	-	-	-
Hydrocyanic Acid (up to 98%)	Water White Liquid	1	1	-	-	-	-	-	-	1	-	-	-	-	X	1	1	1	X	-	-
Hydrafluid 760 (Texaco and Houghton)	Liquid	1	1	-	X	1	-	-	-	X	1	-	-	1	-	1	1	1	1	1	-
Hydrafluid AZR&O, A, B, AA, C	Liquid	1	1	-	X	1	-	-	-	X	1	-	-	1	-	1	1	1	1	1	-
Hydrasol A (Textile Dying)	-	1	1	-	X	1	-	-	-	X	1	-	-	1	-	1	1	1	1	-	-
Hydraulic Fluid (Phosphate Ester Base)	Liquid	1	1	-	1	X	-	-	X	1	1	-	-	1	1	1	1	1	-	-	-
Hydraulic Fluid (Polyalphaolfin)	Liquid	1	-	-	-	-	-	-	-	1	-	-	-	-	1	1	1	1	1	1	-
Hydraulic Fluid (Std. Petroleum Oils)	Liquid	1	1	-	X	1	X	X	2	X	1	2	1	1	1	1	1	1	1	1	-
Hydraulic Fluid (Water Glycol Base)	Liquid	1	1	-	-	1	2	2	1	1	1	-	-	1	1	1	1	1	1	1	-
Hydraulic Fluid HF-18, HF-20	Liquid	1	1	-	1	1	-	-	-	1	1	-	-	1	2	1	1	1	1	1	-
Hydraulic Fluid HF-31	Liquid	1	1	-	X	-	-	-	-	X	-	-	-	1	-	1	1	1	1	1	-
Hydrazine	Colorless Fuming Liquid	1	1	-	2	X	X	X	X	2	X	X	-	-	X	-	-	-	-	-	-
Hydrazine Hydrate	Colorless Fuming Liquid	1	1	-	2	X	X	X	X	2	X	X	-	-	X	-	-	-	-	-	-
Hydrazine Solution	Liquid	1	1	-	2	X	X	X	X	2	X	X	-	-	X	-	-	-	-	-	-
Hydro-Drive Oil (Houghton)	Liquid	1	-	-	X	1	-	-	-	X	-	-	-	-	2	-	-	-	-	-	-
Hydrobromic Acid (62% and less)	Colorless to Yellow Liquid	1	1	1	X	X	2	2	X	2	1	2	1	X	X	-	-	-	X	-	-
Hydrobromic Acid (to 48%)	Colorless to Yellow Liquid	1	1	1	1	X	2	2	X	2	1	2	1	X	X	-	-	-	X	-	-
Hydrochloric Acid (15%)	Colorless to Yellow Liquid	1	1	1	2	X	2	2	X	2	1	2	1	X	X	X	X	X	X	X	-
Hydrochloric Acid (37%)	Colorless to Yellow Liquid	1	1	1	X	X	2	2	X	2	1	2	1	X	X	X	X	X	X	X	-
Hydrochloric Acid, anhydrous	Colorless Fuming Gas	1	-	-	-	-	-	-	-	1	-	-	-	-	X	X	X	X	X	-	-
Hydrocyanic Acid (10% Solution with water)	Water White Liquid	1	1	1	-	X	2	2	X	-	1	2	-	-	X	X	1	1	1	X	-
Hydrocyanic Acid (98% or less)	Water White Liquid below 77°F/25°C	1	-	-	-	-	-	-	-	1	-	-	-	-	X	-	-	-	-	-	-
Hydrocyanic Acid (up to 20%)	Water White Liquid	1	1	-	1	2	2	2	2	-	1	1	-	-	2	-	-	-	-	-	-
Hydrofluoric Acid (38% or less)	Colorless Liquid	1	1	1	2	X	X	X	2	2	1	1	1	X	X	X	X	X	X	X	-
Hydrofluoric Acid (47% or less)	Colorless Liquid	1	1	1	2	X	X	X	2	2	1	2	1	X	X	X	X	X	X	X	-
Hydrofluoric Acid (53% or less)	Colorless Liquid	1	1	X	-	X	X	X	2	X	1	2	1	X	X	X	X	X	X	X	-
Hydrofluoric Acid (70%)	Colorless Liquid	1	1	X	X	X	X	X	X	-	1	2	-	X	X	X	X	X	X	X	-
Hydrofluoric Acid (Concentrated)	Colorless Liquid	1	1	X	X	X	X	X	X	X	2	2	1	X	X	X	X	X	X	X	-
Hydrofluosilicic Acid	In Water	1	1	1	2	X	X	X	X	X	1	1	X	X	X	X	X	X	-	1	-
Hydrogen (Gas)	Gas	CONTACT DENVER PRODUCT APPLICATION														-	-	-	-	-	-
Hydrogen Bromide Liquefied (Anhydrous)	Liquid	1	-	-	1	X	X	X	-	X	1	-	-	-	-	-	-	-	-	-	-
Hydrogen Bromide Solution (Hydrobromic Acid)	Liquid	1	-	-	-	-	-	-	-	-	-	-	-	-	-	-	-	-	-	-	-
Hydrogen Bromide, Anhydride	Colorless Gas	1	-	-	-	-	-	-	-	-	-	-	-	-	-	-	-	-	-	-	-
Hydrogen Chloride	Colorless Fuming Gas	1	-	-	-	-	-	-	-	1	-	1	-	-	-	-	-	-	-	-	-
Hydrogen Dioxide (Hydrogen Peroxide)	Liquid	1	-	-	2	X	-	-	2	-	1	1	-	-	-	-	-	-	-	-	-
Hydrogen Fluoride	Colorless Gas or Liquid	1	-	-	1	X	X	X	-	2	X	-	-	-	-	1	1	1	-	-	-
Hydrogen Peroxide (35% or less)	Liquid	1	1	1	1	2	X	X	1	X	1	1	1	1	1	X	2	1	1	X	-
Hydrogen Peroxide (50% or less)	Liquid	1	2	1	1	2	X	X	1	X	1	1	1	2	2	X	2	1	1	X	-
Hydrogen Peroxide (70% or less)	Liquid	1	2	1	2	X	X	X	2	-	1	1	1	X	2	X	2	1	1	X	-
Hydrogen Peroxide (90% or less)	Liquid	1	-	1	2	X	X	X	2	-	1	1	-	X	X	X	2	1	1	X	-
Hydrogen Sulfide	Colorless Gas	NO HOSE AVAILABLE														-	-	-	-	-	-
Hydrogen Sulfide, Liquefied	Liquid @ 410 PSI, 120°F (49°C)	1	-	-	1	X	X	-	2	X	X	-	-	-	-	-	-	-	-	-	-
Hydrolube (Water Glycol)	Liquid	1	-	1	1	1	-	-	2	2	1	-	-	-	1	-	-	-	-	-	-
Hydrolubric Oil (Houghton)	Liquid	1	1	-	X	2	-	-	-	X	-	-	-	1	2	-	-	-	-	-	-
Hydroquinone	White Crystals	1	1	-	X	-	X	X	X	X	2	X	-	-	-	-	1	1	-	-	-
Hydroquinone Solution	Liquid	1	-	-	-	X	X	-	X	X	1	-	-	-	2	-	1	1	-	-	-
Hydroxyacetic Acid	Colorless Crystals	-	-	-	-	-	-	1	-	-	-	-	-	-	-	-	-	-	-	-	-
Hydroxyacetic Acid Solution	Liquid	1	1	1	2	-	-	-	-	-	-	-	-	-	-	-	-	-	-	-	-

CHEMICAL RESISTANCE TABLE



CHEMICAL	FORM (AT ROOM TEMPERATURE UNLESS OTHERWISE STATED)	GATES HOSE / POLYMERS														COUPLINGS					
		Teflon®	XLPE	UHMWPE	EPDM	NR	SBR	NR	CR	Butyl	Fluorocarbon	Hypalon®	CPE	Nylon	PVC	Iron/Carbon Steel	Stainless Steel 304	Stainless Steel 316	Aluminum	Brass	Polypro
		1	1	1	X	-	-	-	-	-	1	-	1	-	-	-	-	-	-	-	-
Hydroxyethyl Acrylate (HEA)	Liquid	1	1	1	X	-	-	-	-	-	1	-	1	-	-	-	-	-	-	-	-
Hydroxyethyl Acrylate Acid (HEA Acid)	Liquid	1	1	1	X	-	-	-	-	-	1	-	1	-	-	-	-	-	-	-	-
Hydroxyethyl Methacrylate	Clear Liquid	1	-	-	-	-	-	-	-	-	1	-	-	-	-	-	-	-	-	-	-
Hydroxyethyl Methacrylate Solution in Xylene	Clear Liquid	1	2	-	-	-	-	-	-	-	1	-	-	-	-	-	-	-	-	-	-
Hydroxypropyl Acrylate Acid (HPA Acid)	Liquid	1	1	1	X	-	-	-	-	-	1	-	1	-	-	-	-	-	-	-	-
Hylene (Toluene Diisocyanate)	Yellow Liquid	1	-	-	2	X	X	X	X	2	X	X	-	-	-	-	-	-	-	-	-
Hypochlorous Acid (only in dilute solutions)	Greenish-Yellow Aqueous Sol.	1	1	1	2	X	X	X	X	X	1	2	-	-	-	-	-	-	-	-	-
I																					
Ink (Printers)	Liquid	1	1	-	X	2	X	X	-	X	X	-	-	1	-	2	2	1	-	2	-
Ink Oil	Liquid	1	2	-	-	2	-	-	-	-	-	-	-	-	-	1	1	1	-	1	-
Insulating Oil (Transformer) ¹	Liquid	1	1	-	X	1	X	X	2	X	1	X	-	-	-	1	1	1	-	1	-
Iodine	Grayish Black Granules	1	-	-	-	-	-	1	X	-	-	-	-	-	X	X	X	X	-	-	-
Iodine Solution	Liquid	1	1	1	1	-	-	-	-	-	1	-	-	-	-	-	-	-	-	-	-
Iodine, In Alcohol	Liquid	1	1	1	1	-	X	X	2	-	1	-	1	-	1	-	-	-	-	-	-
Iron Acetate Liquor (Black Liquor)	Black Liquid	1	1	1	2	2	X	X	2	2	1	2	2	-	1	1	1	1	-	-	1
Iron Hydroxide	Brown precipitate	1	-	-	1	1	-	X	1	1	1	1	-	-	-	-	-	-	-	-	-
Iron Ore (Hematite)	Black to Brick Red	-	-	-	-	-	-	1	-	-	-	-	-	-	-	-	-	-	-	-	-
Iron Oxide (Black, Brown, Red or Yellow)	Solid	-	-	-	-	-	-	1	-	-	-	-	-	-	-	-	-	-	-	-	-
Iron Oxide Slurry	Slurry	-	-	-	-	-	-	1	-	-	-	-	-	-	-	-	-	-	-	-	-
Iron Salts	-	1	-	-	1	1	-	1	1	1	1	1	-	1	1	-	-	-	-	-	-
Iron Sulfate Solution (Ferric Sulfate)	Liquid	1	1	1	2	2	2	-	2	2	1	2	1	-	1	X	1	1	X	X	1
Iron Sulfide Solution (Ferrous Sulfide)	Liquid	1	1	-	-	-	-	-	-	-	1	-	-	-	-	-	-	-	-	-	-
Isoamyl Acetate	Colorless Liquid	1	-	-	2	X	-	X	X	X	X	X	-	-	-	-	-	-	-	-	-
Isoamyl Alcohol (Isobutyl Carbinol)	Colorless Liquid	1	-	-	2	2	-	2	2	2	2	2	-	-	-	-	-	-	-	-	-
Isoamyl Bromide	-	1	-	-	X	X	-	X	X	X	2	X	-	-	-	-	-	-	-	-	-
Isoamyl Butyrate	Water White Liquid	1	-	-	-	X	-	X	-	X	X	X	-	-	-	-	-	-	-	-	-
Isoamyl Chloride	Colorless to Yellow Liquid	1	2	-	-	-	-	-	-	-	1	-	-	-	-	-	-	-	-	-	-
Isoamyl Ether	Colorless Liquid	1	-	-	-	X	-	X	-	X	X	X	-	-	-	-	-	-	-	-	-
Isoamyl Phthalate	Colorless Liquid	1	-	-	-	X	-	X	-	2	X	X	-	-	-	-	-	-	-	-	-
Isobutane	Colorless Gas	USE LPG HOSE ONLY														-	-	-	-	-	-
Isobutane Liquid	Liquid @ 98 PSIG, 120°F (49°C)	1	-	-	-	-	-	-	-	-	1	-	-	-	-	-	-	-	-	-	-
Isobutanol (Isobutyl Alcohol)	Colorless Liquid	1	1	1	1	2	2	2	2	2	1	1	1	1	2	1	1	1	1	2	-
Isobutene (Isobutylene)	Gas	1	-	-	X	1	X	X	-	-	2	X	-	-	-	-	-	-	-	-	-
Isobutyl Acetate	Colorless Liquid	1	-	-	X	X	-	X	X	X	X	X	-	-	-	-	-	-	-	-	-
Isobutyl Alcohol (Isobutanol)	Colorless Liquid	1	1	1	1	2	2	2	2	2	1	1	1	1	2	1	1	1	1	2	-
Isobutyl Aldehyde (Isobutyraldehyde)	Colorless Liquid	1	-	-	2	X	-	X	X	X	X	X	-	-	-	-	-	-	-	-	-
Isobutyl Carbinol (Primary Isoamyl Alcohol)	Colorless Liquid	1	-	-	2	2	-	2	2	2	2	2	-	-	-	-	-	-	-	-	-
Isobutylamine	Colorless Liquid	1	-	-	-	X	-	X	-	2	X	X	-	-	-	-	-	-	-	-	-
Isobutylene (Isobutene)	Gas	1	-	-	X	1	X	X	-	-	2	X	-	-	-	-	-	-	-	-	-
Isobutylene Liquid (Isobutene Liquid)	Liquid @ 88 PSIG, 120°F (49°C)	1	-	-	-	-	-	-	-	-	1	-	-	-	-	-	-	-	-	-	-
Isobutyraldehyde (Isobutyl Aldehyde)	Colorless Liquid	1	-	-	2	X	-	X	X	X	X	X	-	-	-	-	-	-	-	-	-
Isocyanate (Toluene Diisocyanate)	Water White to Yellow Liquid	1	2	-	X	X	X	X	X	X	1	-	-	-	-	1	1	1	-	-	-
Isooctane	Colorless Liquid	1	2	-	X	1	X	X	1	X	1	1	2	1	X	1	1	1	2	1	-
Isooctyl Adipate	Viscous Liquid	1	1	-	-	-	-	-	-	-	1	-	-	-	-	-	-	-	-	-	-
Isooctyl Alcohol	Clear Liquid	1	1	1	1	-	-	-	-	-	1	-	-	-	-	-	-	-	-	-	-
Isooctyl Thioglycolate	Water White Liquid	1	1	-	2	-	-	-	-	-	1	-	-	-	-	-	-	-	-	-	-
Isopentane	Colorless Liquid	1	2	-	-	-	-	-	-	-	1	-	-	-	-	-	-	-	-	-	-
Isophorone	Water White Liquid	1	-	-	-	-	-	-	-	-	-	-	-	-	-	-	-	-	-	-	-
Isophthaloyl Chloride	Liquid above 106°F (41°C)	1	-	-	-	-	-	-	-	-	1	-	-	-	-	-	-	-	-	-	-
Isopropanol (Isopropyl Alcohol)	Colorless Liquid	1	1	1	1	1	2	2	2	1	1	2	1	1	2	1	1	1	1	2	1
Isopropanolamine (MIPA)	Liquid	1	2	-	-	2	-	2	-	1	X	X	-	-	-	-	-	-	-	-	-
Isopropyl Acetate	Colorless Liquid	1	1	1	2	X	X	X	X	2	-	X	-	1	X	1	1	1	1	1	-

TABLE OF CONTENTS

ABOUT GATES

HYDRAULIC HOSE

HYDRAULIC HOSE COUPLINGS

ENGINEERING AND TECHNICAL DATA

CHEMICAL RESISTANCE TABLE



TABLE OF CONTENTS

ABOUT GATES

HYDRAULIC HOSE

HYDRAULIC HOSE COUPLINGS

ENGINEERING AND TECHNICAL DATA

CHEMICAL	FORM (AT ROOM TEMPERATURE UNLESS OTHERWISE STATED)	GATES HOSE / POLYMERS														COUPLINGS					
		Teflon®	XLPE	UHMWPE	EPDM	NR	SBR	NR	CR	Butyl	Fluorocarbon	Hypalon®	CPE	Nylon	PVC	Iron/Carbon Steel	Stainless Steel 304	Stainless Steel 316	Aluminum	Brass	Polypro
Isopropyl Alcohol (Isopropanol)	Colorless Liquid	1	1	1	1	1	2	2	2	1	1	2	1	1	2	1	1	1	1	2	1
Isopropyl Benzene (Cumene)	Colorless Liquid	1	2	-	-	-	-	-	-	-	1	-	2	-	-	-	-	-	-	-	-
Isopropyl Chloride	Colorless Liquid	1	-	-	-	-	-	-	-	-	1	-	-	-	-	-	-	-	-	-	-
Isopropyl Ether	Colorless Liquid	1	1	1	X	X	X	X	X	2	X	X	-	1	X	1	1	1	1	1	-
Isopropylamine	Colorless Liquid	1	1	-	-	-	-	-	-	-	-	-	-	-	-	-	-	-	-	-	-
Isopropylbenzene (Cumene)	Colorless Liquid	1	2	-	-	-	-	-	-	-	1	-	2	-	-	-	-	-	-	-	-
Isopropyltoluene (Cymene)	Colorless Liquid	1	-	-	-	-	-	-	-	-	1	-	-	1	-	1	1	1	1	1	-
J																					
Jet Fuel A and A1 ²	Liquid	1	-	-	-	1	-	-	-	-	1	-	-	-	-	-	-	-	-	-	-
Jet Fuel JP1 ²	Liquid	1	1	-	X	1	X	X	2	X	1	X	-	1	X	-	-	-	-	-	-
Jet Fuel JP10 (Tetrahydrodicyclopentadiene) ²	Liquid	1	-	-	X	X	X	X	X	X	1	X	-	1	X	-	-	-	-	-	-
Jet Fuel JP4 ²	Liquid	1	1	-	X	1	X	X	2	X	1	X	-	1	X	2	1	1	2	1	-
Jet Fuel JP5 ²	Liquid	1	1	-	X	1	X	X	X	X	1	X	-	1	X	2	1	1	2	1	-
Jet Fuel JP8 ²	Liquid	1	1	-	X	1	X	X	X	X	1	X	-	1	X	2	1	1	2	1	-
K																					
Kaolin Clay	White to Yellowish Powder	1	-	1	-	-	-	1	-	-	-	-	-	-	-	-	-	-	-	-	-
Karo Syrup	Yellow Liquid	-	-	-	-	-	-	-	-	-	-	-	-	1	1	-	1	1	-	-	-
Kerosene	Water White Oily Liquid	1	1	-	X	1	X	X	X	X	1	X	1	1	2	1	1	1	1	1	-
Ketchup	Red Liquid	-	-	-	-	1	-	-	1	-	-	-	-	1	-	-	1	1	-	-	-
Ketoglutaric Acid	In Water or Alcohol	1	1	1	2	-	-	-	-	-	-	-	-	-	-	-	-	-	-	-	-
Ketones (ie Acetone, MEK, Cyclohexanone)	Generally Liquids	1	1	1	2	X	X	X	X	2	X	X	-	1	X	1	1	1	1	1	-
Koch Acid	White Solid	-	-	-	-	-	-	1	-	-	-	-	-	-	-	-	-	-	-	-	-
L																					
Lacquer - Alcohol or Acetate as Solvent	Solution	1	1	1	2	-	-	-	-	-	X	-	-	-	-	X	X	1	1	1	-
Lacquer - Toluene or Xylene as Solvent	Solution	1	-	-	-	X	X	X	X	X	1	X	-	1	X	X	X	1	1	1	-
Lactic Acid (90% or less)	Colorless-Yellow Liquid	1	1	1	2	X	2	2	1	-	1	1	-	-	X	X	2	1	X	2	-
Lactic Acid, Food Grade - 50-80%	Colorless to Yellow Liquid	1	1	1	2	-	X	X	-	X	1	1	-	-	X	2	1	X	2	-	-
Lactic Acid, Plastic Grade - 50-80% or less	Colorless to Yellow Liquid	1	1	1	2	1	-	-	1	-	1	1	-	X	1	X	2	1	X	2	-
Lactic Acid, USP 85-90% or less	Colorless to Yellow Syrupy Liquid	-	-	-	-	-	-	-	-	-	-	-	-	-	-	X	2	1	X	2	-
Lactol	-	1	1	-	-	2	-	-	2	-	-	-	-	-	-	1	1	1	-	1	-
Lard (Fat of the Hog)	Liquid above 108°F (42°C)	1	1	1	X	1	X	X	2	X	1	X	1	1	-	1	1	1	1	X	-
Lard Oil	Colorless to Yellow Liquid	1	1	-	-	-	-	-	2	-	X	-	-	-	-	1	1	1	1	X	-
Lasso (Alachlor)	Colorless Crystals	1	1	-	-	-	-	1	-	-	-	-	-	-	-	-	1	1	-	-	-
Latex Paint	Liquid	1	1	1	1	1	2	2	-	2	1	-	-	1	1	1	1	1	1	1	-
Lauryl Peroxide	White Powder	-	-	-	-	-	-	1	-	-	-	-	-	-	-	-	-	-	-	-	-
Lauryl Alcohol	Liquid above 75°F (24°C)	1	-	-	-	-	-	-	-	-	1	-	-	-	-	-	-	-	-	-	-
Lead Acetate	White Crystals	-	-	-	-	-	-	1	-	-	-	-	-	-	-	2	1	1	-	1	-
Lead Acetate Solution	Solution	1	1	1	1	2	2	2	-	2	1	-	1	-	1	2	1	1	-	1	-
Lead Arsenate	White Crystals	1	-	-	-	-	-	1	-	-	-	-	-	-	-	1	1	1	-	-	-
Lead Arsenate Solution (In Nitric Acid)	Solution	1	1	-	-	-	-	-	-	-	1	2	-	-	-	-	-	-	-	-	-
Lead Nitrate Solution (In Water or Alcohol)	Solution	1	1	1	1	1	2	2	2	2	1	-	1	-	1	1	1	1	-	-	-
Lead Silicate (basic)	White Powder	-	-	-	-	-	-	1	-	-	-	-	-	-	-	-	-	-	-	-	-
Lead Sulphate (Basic, Blue Basic, Tribasic)	White to Blue Powder	-	-	-	-	-	-	1	-	-	-	-	-	-	-	1	1	1	-	-	-
Lead, Tetraethyl (Tetraethyl Lead)	Colorless Oily Liquid	1	2	-	X	2	X	X	X	X	1	X	-	2	1	-	-	-	-	-	-
Lead, Tetramethyl (Tetramethyl Lead)	Colorless Liquid	1	-	-	X	2	X	X	X	X	1	X	-	-	-	-	-	-	-	-	-
Lecithin	Light Brown Viscous Liquid-Solid	1	1	-	-	X	-	-	2	-	-	-	-	-	-	-	1	1	-	-	-
Ligroin	Clear Liquid	1	2	-	X	1	X	X	X	X	1	X	-	1	X	2	1	1	-	-	-
Lime (Calcium Oxide)	White to Gray Lumpy Solid	-	-	-	-	-	-	1	-	-	-	-	-	-	-	-	-	2	-	-	-
Lime Sulfur Solution	Solution	1	1	1	2	X	X	X	1	X	1	2	-	-	2	2	1	1	X	X	-
Lime, Chlorinated (Bleaching Solution)	Solution	1	1	1	2	2	2	2	X	2	1	X	-	-	2	X	2	1	-	-	-
Lime, Chlorinated (normal 35-37% Chlorine)	White Powder	-	-	-	-	-	-	1	-	-	-	-	-	-	-	-	-	2	-	-	-
Lime, Hydraulic (Calced Limestone)	Powder	-	-	-	-	-	-	1	-	-	-	-	-	-	-	-	-	-	-	-	-

CHEMICAL RESISTANCE TABLE



CHEMICAL	FORM (AT ROOM TEMPERATURE UNLESS OTHERWISE STATED)	GATES HOSE / POLYMERS														COUPLINGS					
		Teflon®	XLPE	UHMWPE	EPDM	NR	SBR	NR	CR	Butyl	Fluorocarbon	Hypalon®	CPE	Nylon	PVC	Iron/Carbon Steel	Stainless Steel 304	Stainless Steel 316	Aluminum	Brass	Polypro
Lime, Slaked (Calcium Hydroxide)	White Crystalline Powder	-	-	-	-	-	-	1	-	-	-	-	-	-	-	-	-	-	-	-	-
Limestone	Powder or Lumps	-	-	-	-	-	-	1	-	-	-	-	-	-	-	-	-	-	-	-	-
Limonene	Colorless Liquid	1	2	1	X	X	X	X	-	-	1	-	-	1	-	1	1	1	1	1	-
Lindane (Ag Spray)	-	1	1	-	-	-	-	-	-	-	-	-	1	-	-	1	1	-	-	-	-
Linoleic Acid	Colorless to Straw Colored Liquid	1	1	1	X	2	-	-	X	X	1	-	-	1	-	-	-	-	-	-	-
Linseed Oil	Yellow Amber to Brown Liquid	1	1	X	2	2	X	X	2	-	1	1	1	1	1	2	1	1	1	2	-
Liquid Soap	Liquid	1	1	1	2	-	2	2	-	2	-	-	-	2	1	1	1	1	1	1	-
Lithium Chloride	White Crystals	-	-	X	-	-	-	1	-	-	-	-	-	-	-	-	-	-	-	-	-
Lithium Chloride (35-40% Brine)	Solution	X	1	X	-	-	-	-	-	-	1	-	-	-	-	-	-	-	-	-	-
Lubricating Oil Diester Under 135°F (57°C)	Liquid	1	1	-	X	2	X	X	-	X	1	-	-	X	1	1	1	1	1	1	-
Lubricating Oil (SAE 10, 20, 30, 40, & 50)	Liquid	1	-	-	-	2	-	-	2	-	-	-	1	-	1	1	1	1	1	1	-
Lubricating Oil Under 120°F (49°C)	Liquid	1	1	-	X	1	X	X	2	X	1	2	1	1	2	1	1	1	1	1	-
M																					
Machine Oil Under 135°F (57°C)	Liquid	1	1	-	X	1	X	X	1	X	1	2	-	1	2	1	1	1	1	1	-
Magnesite	White to Brown Crystalline Solid	-	-	-	-	-	-	1	-	-	-	-	-	-	-	-	-	-	-	-	-
Magnesium	Powder	-	-	-	-	-	-	1	-	-	-	-	-	-	-	-	-	-	-	-	-
Magnesium Acetate	Colorless Crystalline Aggregate	-	-	-	-	-	-	1	-	-	-	-	-	-	-	-	-	-	-	-	-
Magnesium Acetate Solution	In Water or Alcohol	1	1	1	1	1	1	1	-	1	1	1	1	1	1	-	-	-	-	-	-
Magnesium Carbonate	White Powder	-	-	-	-	-	-	1	-	-	-	-	-	-	1	1	1	-	-	-	-
Magnesium Carbonate Solution (in Acid)	Liquid Solution	1	1	1	-	-	-	-	-	-	1	-	-	-	1	1	1	-	-	-	-
Magnesium Chloride	Colorless to White Crystals	1	-	1	-	-	-	1	-	-	-	-	-	-	X	2	1	X	2	-	-
Magnesium Chloride Brine	Solution	1	1	1	1	1	-	1	-	-	1	-	-	-	-	-	-	-	-	-	-
Magnesium Chloride, Hydrated (in H2O or Alcohol)	Solution	1	1	1	1	-	-	1	-	-	1	-	-	-	-	-	-	-	-	-	-
Magnesium Hydroxide	White Powder	-	-	-	-	-	-	1	-	-	-	-	-	-	1	1	1	X	-	-	-
Magnesium Hydroxide Solution (in Dilute Acid)	Liquid Solution	1	1	1	-	-	-	-	-	1	-	-	-	-	1	1	1	X	-	-	-
Magnesium Nitrate	White Crystals	-	-	-	-	-	-	1	-	-	-	-	-	-	1	1	1	X	1	-	-
Magnesium Nitrate Solution (in H2O or Alcohol)	Liquid Solution	1	1	1	1	1	-	-	-	1	-	-	-	-	1	1	1	X	1	-	-
Magnesium Oxide, Dry	White Powder	-	-	-	-	-	-	1	-	-	-	-	-	-	-	-	-	-	-	-	-
Magnesium Oxide, Slurry	-	1	1	-	1	2	-	2	1	-	1	-	-	-	-	-	-	-	-	-	-
Magnesium Sulfate Solution	Liquid Solution	1	1	1	1	1	1	1	2	1	1	1	1	-	1	2	1	1	-	1	-
Malathion (Ag Spray Dilute)	Clear to Amber Liquid	1	1	1	2	-	X	X	-	1	1	-	-	1	1	1	1	1	-	1	-
Malathion (Ag Spray)	Clear to Amber Liquid	1	1	-	2	-	-	-	-	1	-	-	-	1	-	1	1	1	-	1	-
Maleic Acid	Liquid	NO HOSE AVAILABLE														2	2	1	-	-	-
Maleic Acid Solution	Solution	1	1	1	1	2	2	2	X	-	7	-	-	-	X	2	2	1	-	-	-
Maleic Anhydride	Colorless Needles	1	-	-	-	-	-	-	-	-	-	-	-	-	-	-	-	-	-	-	-
Maleic Anhydride (Heated Liquid)	Liquid above 124°F (53°C)	1	-	X	-	-	-	-	-	-	-	-	-	-	-	-	-	-	-	-	-
Malic Acid (dl form)	Colorless Crystals	-	-	-	-	-	-	1	-	-	-	-	-	-	-	-	-	-	-	-	-
Malic Acid Solution (in H2O or Alcohol)	Solution	1	1	1	2	-	-	-	-	-	1	-	-	-	-	-	-	-	-	-	-
Malt Extract (Maltine)	Light Brown Viscous Liquid	1	1	1	1	-	-	-	-	-	1	-	-	-	-	-	-	-	-	-	-
Malt, Dry	Yellow to Amber Grain	-	-	-	-	-	-	1	-	-	-	-	-	-	-	-	-	-	-	-	-
Maltine (Malt Extract)	Light Brown Viscous Liquid	1	1	1	1	-	-	-	-	-	1	-	-	-	-	-	-	-	-	-	-
Manganese Salts	-	1	1	-	-	1	X	X	-	-	1	1	-	-	1	-	-	-	-	-	-
Manganese Sulfate (Manganous Sulfate)	Pale Red Solid	-	-	-	-	-	-	1	-	-	-	-	-	-	-	-	-	-	-	-	-
Manganese Sulfate Solution	Solution in Water	1	1	-	-	1	2	2	-	-	1	1	1	-	1	-	-	-	-	-	-
Manganese Sulfide (Manganous Sulfide)	Green Crystals	-	-	-	-	-	-	1	-	-	-	-	-	-	-	-	-	-	-	-	-
Manganese Sulfite (Manganous Sulfite)	Black to Brownish Red Powder	-	-	-	-	-	-	1	-	-	-	-	-	-	-	-	-	-	-	-	-
MAPP Gas (Methylacetylene Propadiene)	Liquid	USE 20B-HB HOSE ONLY														-	-	-	-	-	-
Maxmul (Penzoil Hydraulic Fluid)	Liquid	1	-	-	-	1	-	-	2	-	-	-	-	-	-	1	-	1	-	-	-
Mayonnaise	Semi-Liquid	1	1	-	-	-	-	-	-	-	-	-	-	-	1	-	-	-	-	-	-
MBK (Methyl Butyl Ketone)	Colorless Liquid	1	1	-	2	X	X	X	X	2	X	X	2	-	X	1	1	1	1	1	-
MEA (Ethanalamine)	Colorless Viscous Liquid	1	1	1	2	2	2	2	2	1	X	X	1	-	2	-	-	-	-	-	-
MEK (Ethyl Methyl Ketone)	Colorless Liquid	1	2	1	2	X	X	X	X	2	X	X	2	1	X	1	1	1	1	1	-

TABLE OF CONTENTS
ABOUT GATES
HYDRAULIC HOSE
HYDRAULIC HOSE COUPLINGS
ENGINEERING AND TECHNICAL DATA

CHEMICAL RESISTANCE TABLE



TABLE OF CONTENTS

ABOUT GATES

HYDRAULIC HOSE

HYDRAULIC HOSE COUPLINGS

ENGINEERING AND TECHNICAL DATA

CHEMICAL	FORM (AT ROOM TEMPERATURE UNLESS OTHERWISE STATED)	GATES HOSE / POLYMERS														COUPLINGS						
		Teflon®	XLPE	UHMWPE	EPDM	NR	SBR	NR	CR	Butyl	Fluorocarbon	Hypalon®	CPE	Nylon	PVC	Iron/Carbon Steel	Stainless Steel 304	Stainless Steel 316	Aluminum	Brass	Polypro	
Mercuric Chloride	White Powder	-	-	-	-	-	-	1	-	-	-	-	-	-	-	X	1	1	X	X	-	
Mercuric Chloride Solution (in H2O, or Alcohol)	Solution	1	1	-	2	2	2	1	1	2	-	1	1	-	2	X	1	1	X	X	-	
Mercuric Cyanide	Colorless Transparent Prisms	-	-	-	-	-	-	1	-	-	-	-	-	-	-	-	-	-	X	-	-	
Mercuric Cyanide Solution (in H2O or Alcohol)	Solution	1	1	-	2	2	2	2	1	2	-	1	-	-	-	-	-	-	X	-	-	
Mercurous Nitrate Solution	Solution	1	1	1	2	-	-	-	-	-	1	-	-	-	-	1	1	1	X	-	-	
Mercury	Silver Liquid	1	1	1	-	2	2	2	1	2	-	1	1	-	1	1	1	X	X	-	-	
Mercury Vapor	Gas	NO HOSE AVAILABLE														1	1	1	-	-	-	
Mesityl Oxide (Methyl Isobutenyl Ketone)	Colorless Oily Liquid	1	1	1	2	X	X	X	X	2	X	X	2	-	X	1	1	1	1	1	1	-
Mesitylene (Trimethylbenzene)	Liquid	1	-	-	X	X	X	X	X	X	1	-	-	1	X	-	-	-	-	-	-	-
Metallic Soaps (Aluminium, Calcium, Zinc)	Solids @ Room Temperature	1	1	1	X	1	X	X	-	X	1	2	1	-	-	1	1	1	1	1	-	
Methyl Alcohol (Methylalcohol)	Colorless Liquid	1	-	-	-	1	-	2	-	2	2	2	-	-	-	-	-	-	-	-	-	
Methane	Gas	1	-	-	-	1	-	-	-	-	1	-	-	-	-	-	-	-	-	-	-	
Methanol (Methyl Alcohol)	Colorless Liquid	1	1	1	1	1	1	1	1	1	X	1	1	1	2	1	1	1	1	2	-	
Methionine	White Crystalline Powder	-	-	-	-	-	-	1	-	-	-	-	-	-	-	-	-	-	-	-	-	
Methoxychlor Solution (in Alcohol)	Solution	1	1	-	-	-	-	-	-	-	-	-	-	1	-	1	1	1	-	-	-	
Methylamine (Monomethylamine)	Liquid	1	-	-	-	-	-	-	-	-	-	-	1	X	1	1	1	-	-	-	-	
Methyl Acetate	Colorless Liquid	1	2	-	2	X	X	X	X	2	X	X	1	1	X	1	1	1	1	1	-	
Methyl Acetoacetate	Colorless Liquid	1	-	-	2	X	-	X	X	2	X	X	-	-	-	-	-	-	-	-	-	
Methyl Acetone	Water White Liquid	1	-	-	1	X	-	X	-	2	X	X	-	-	1	-	-	-	-	-	-	
Methyl Acrylate (Inhibited)	Colorless Liquid	1	2	-	2	X	X	X	X	X	X	X	-	-	-	1	1	1	1	1	-	
Methyl Acrylate Acid (Methylacrylic Acid)	White Solid	1	1	1	2	2	X	X	-	1	1	-	1	X	-	-	-	-	-	-	-	
Methyl Alcohol (100%) (Methanol)	Colorless Liquid	1	1	1	1	1	1	1	1	1	X	1	1	1	2	1	1	1	1	2	-	
Methyl Bromide	Liquid @ 55 PSIG @ 120°F (49°C)	1	1	-	X	X	X	X	X	X	1	X	-	1	X	1	1	1	-	1	-	
Methyl Bromoacetate	Colorless to Straw Colored Liquid	1	1	1	-	-	-	-	-	-	-	-	-	-	-	-	-	-	-	-	-	
Methyl Butanethiol (Butyl Mercaptan)	Liquid	1	1	-	X	-	X	X	-	X	1	-	-	-	X	-	1	1	-	-	-	
Methyl Butanol (2-Methyl-1-Butanol)	Colorless Liquid	1	1	1	1	1	-	-	-	1	1	-	1	1	1	-	-	-	-	-	-	
Methyl Butyl Ketone (MBK)	Colorless Liquid	1	1	-	2	X	X	X	X	2	X	X	2	-	X	1	1	1	1	1	-	
Methyl Carbitol (Diethylene Glycol Methyl Ether)	Colorless Liquid	1	1	-	1	-	X	X	-	X	1	X	1	-	-	-	-	-	-	-	-	
Methyl Cellosolve (Diethylene Glycol Methyl Ether)	Colorless Liquid	1	1	-	1	-	X	X	-	X	1	X	1	-	-	-	-	-	-	-	-	
Methyl Chloride	Liquid @ 160 PSIG @ 120°F (49°C)	1	2	-	X	X	X	X	X	X	1	X	X	-	X	1	1	1	-	1	-	
Methyl Chloroform (1,1,1 Trichloroethane)	Colorless Liquid	1	2	-	X	X	X	X	X	X	1	X	X	X	X	-	-	-	-	-	-	
Methyl Chloroformate	Colorless Liquid	1	-	-	X	X	X	X	X	X	1	X	-	-	-	-	-	-	-	-	-	
Methyl Cyanide (Acetonitrile)	Colorless Liquid	1	1	2	2	X	2	2	X	X	X	X	1	-	1	1	1	-	-	-	-	
Methyl Cyclohexane	Colorless Liquid	1	-	-	X	1	X	X	-	X	1	X	2	1	-	-	-	-	-	-	-	
Methyl Ethyl Ketone (MEK)	Colorless Liquid	1	2	1	2	X	X	X	X	2	X	X	2	1	X	1	1	1	1	1	-	
Methyl Formate	Colorless Liquid	1	1	-	2	X	X	X	2	2	X	X	-	-	1	1	1	1	1	1	-	
Methyl Hexanol	-	1	-	-	-	1	-	1	-	1	2	1	-	-	-	-	-	-	-	-	-	
Methyl Hexanone (Methyl Isoamyl Ketone)	Colorless Liquid	1	-	-	-	X	-	X	-	2	X	X	-	-	-	-	-	-	-	-	-	
Methyl Hexyl Ketone	Colorless Liquid	1	-	-	-	X	-	X	-	2	X	X	-	-	-	-	-	-	-	-	-	
Methyl Isoamyl Ketone (Methyl Hexanone)	Colorless Liquid	1	-	-	-	X	-	X	-	2	X	X	-	-	-	-	-	-	-	-	-	
Methyl Isobutenyl Ketone (Mesityl Oxide)	Colorless Oily Liquid	1	1	1	2	X	X	X	X	2	X	X	2	-	X	1	1	1	1	1	-	
Methyl Isobutyl Ketone (MIBK)	Colorless Liquid	1	2	-	-	X	X	X	X	2	X	X	2	1	X	-	-	-	-	-	-	
Methyl Isopropyl Ketone	Colorless Liquid	1	2	-	2	X	X	X	X	2	X	X	2	1	X	1	1	1	1	1	-	
Methyl Methacrylate	Colorless Liquid	1	2	-	2	X	X	X	X	X	2	2	-	1	1	1	1	-	-	-	-	
Methyl Methacrylate Monomer, Inhibited	Colorless Liquid	1	-	-	X	X	X	X	X	X	X	X	-	X	X	-	-	-	-	-	-	
Methyl Phenol (Cresol)	Liquid above 95°F (35°C)	1	2	-	-	X	X	X	X	2	1	X	1	X	-	2	1	1	1	-	2	
Methyl Propyl Carbinol (2 Pentanol)	Colorless Liquid	1	1	1	1	-	-	-	-	1	1	-	1	-	-	-	-	-	-	-	-	
Methyl Propyl Ether	Colorless Liquid	1	-	-	-	X	-	X	-	X	-	2	-	-	-	-	-	-	-	-	-	
Methyl Propyl Ketone (Pentanone)	Water White Liquid	1	-	-	2	X	-	X	X	2	X	X	-	-	X	-	-	-	-	-	-	
Methyl Salicylate	Yellow to Red Liquid	1	1	-	2	2	-	-	2	2	-	-	-	-	1	1	1	1	1	1	-	
Methyl Stearate	Liquid above 99°F (38°C)	1	1	-	-	-	-	-	-	-	-	-	-	-	-	-	-	-	-	-	-	
Methyl Sulfate (Dimethyl Sulfate)	Colorless Liquid	1	1	-	X	X	X	X	X	2	X	X	-	1	1	-	-	-	-	-	-	

CHEMICAL RESISTANCE TABLE



CHEMICAL	FORM (AT ROOM TEMPERATURE UNLESS OTHERWISE STATED)	GATES HOSE / POLYMERS														COUPLINGS					
		Teflon®	XLPE	UHMWPE	EPDM	NBR	SBR	NR	CR	Butyl	Fluorocarbon	Hypalon®	CPE	Nylon	PVC	Iron/Carbon Steel	Stainless Steel 304	Stainless Steel 316	Aluminum	Brass	Polypro
Octyl Carbinol (Nonyl Alcohol)	Colorless Liquid	1	1	1	-	1	-	-	-	-	1	-	-	-	-	-	-	-	-	-	-
Octyl Phenol (Diisobutyl Phenol)	White Flakes	1	-	-	-	-	-	1	-	-	-	-	-	-	-	-	-	-	-	-	-
Octylamine	Water White Liquid	1	-	-	-	X	-	X	-	2	X	X	-	-	-	-	-	-	-	-	-
Oil (SAE Motor Oils)	Liquid	1	1	-	X	1	X	X	2	X	1	2	1	1	2	-	-	-	-	-	-
Oil of Turpentine	Liquid	1	2	2	X	1	X	X	2	X	1	X	-	1	1	-	-	-	-	-	-
Oils, Animal (High Fatty Acid Content)	Solid to Liquids	1	2	-	X	1	X	X	2	2	1	X	1	-	2	1	1	1	1	1	-
Oils, Mineral (Aliphatic or Aromatic)	Liquids	1	2	-	X	2	X	X	X	X	1	2	2	1	X	-	-	-	-	-	2
Oils, Vegetable (Soybean, Coconut, Corn)	Liquids	1	1	-	X	1	X	X	-	X	1	X	-	1	-	-	-	-	-	-	1
Oleic Acid (fatty acid)	Yellow to Red Oily Liquid	1	2	2	2	X	X	2	2	2	X	2	-	2	2	2	1	1	2	1	1
Oleum (Fuming Sulfuric, 30% SO3 or less)	Clear to Off White Fuming Liquid	1	X	X	X	X	X	X	X	X	1	X	X	X	X	-	-	1	-	-	X
Olive Oil	Yellow to Green Liquid	1	1	1	2	2	X	X	X	2	1	X	2	1	2	2	1	1	1	2	1
Ortho-Dichlorobenzene (also meta and para)	Colorless Liquid	1	2	-	X	X	X	X	X	X	1	X	X	1	X	-	1	1	-	1	-
Ortho-xylene (1,2 Dimethylbenzene)	Clear Colorless Liquid	1	X	X	X	X	X	X	X	X	1	X	X	X	X	-	-	-	-	-	-
OS 45 Hydraulic Fluid (Silicate Ester Base)	Liquid	1	-	-	X	2	X	X	1	X	1	2	-	-	-	-	-	-	-	-	-
Oxalic Acid	Transparent Crystals	1	-	2	-	-	-	1	-	-	-	-	-	-	-	X	2	1	2	X	1
Oxalic Acid (50%)	Crystals in H2O	1	2	1	2	X	X	X	X	2	1	2	1	X	X	-	-	-	-	-	-
Oxygen	Colorless Gas	1	1	-	1	2	2	2	-	1	1	1	1	-	-	-	-	-	-	-	-
Oxygen, Refrigerated Liquid	Liquid @ 200 PSIG @ -146°C	NO HOSE AVAILABLE														-	-	-	-	-	-
Ozone	Gas	1	2	2	1	X	X	X	2	2	2	2	1	2	1	1	1	1	1	1	1
P																					
Paint (Emulsion or Latex)	Liquid	1	1	1	2	2	-	-	-	-	1	-	-	1	1	-	-	-	-	-	-
Paint (Inorganic)	Liquid	1	-	1	-	-	-	-	-	-	-	-	-	-	-	1	1	1	1	1	-
Paint (Oil or Solvent Based)	Liquid or Paste	1	1	-	X	2	X	X	-	X	1	X	-	1	-	-	-	-	-	-	-
Paint Remover	Liquid or Paste	1	2	-	X	X	X	X	X	X	1	X	-	X	-	-	-	-	-	-	-
Paint Resin	-	1	-	-	-	-	-	-	-	-	-	-	-	-	-	-	-	-	-	-	-
Palm Oil	Yellow to Brown Solid	1	1	-	-	1	X	X	2	2	-	2	-	-	-	1	1	1	1	1	-
Palmitic Acid (Hexadecanoic Acid)	Crystals in Hot Alcohols	1	1	1	2	2	X	X	2	2	1	X	1	-	-	1	2	1	1	X	1
Papermakers Alum (Aluminum Ammonium Sulfate)	In Water	1	1	-	-	-	-	-	-	-	-	-	-	-	-	-	-	-	-	-	-
Paraffin (Aliphatic Hydrocarbon)	Varies from Gas to Waxy Solid	1	1	1	X	1	X	X	2	X	1	X	1	-	-	2	1	1	-	1	-
Paraformaldehyde	White Solid - Flakes or Powder	1	-	-	-	2	-	1	2	-	-	-	-	-	1	-	1	1	1	-	-
Paraldehyde	Colorless Liquid	1	-	-	-	-	-	-	-	-	-	-	-	-	-	-	-	-	-	-	-
Paranox (Detergent, Disperser; Exxon)	-	1	-	1	-	-	-	-	-	-	-	-	-	-	-	-	-	-	-	-	-
Parapol (Liquid Polyisobutylene; Exxon)	Liquid	1	-	-	-	-	-	-	-	-	1	-	-	-	-	-	-	-	-	-	-
Peanut Oil	Yellow to Green Liquid	1	1	-	-	1	-	-	2	X	-	-	-	-	2	1	1	1	1	1	1
Pelargonic Acid	Colorless to Yellow Oil	1	-	-	-	-	-	-	-	-	-	-	-	-	-	-	-	-	-	-	-
Pentachloroethane	Colorless Liquid	1	-	-	-	-	-	-	-	-	1	-	-	-	-	-	-	-	-	-	-
Pentachlorophenol In Oil	In Oil (Wood Preservative)	1	1	1	X	X	X	X	X	1	1	-	-	-	X	-	-	-	-	-	-
Pentaerythritol (Monopentaerythritol)	White Powder	-	-	-	-	-	-	1	-	-	-	-	-	-	-	-	-	-	-	-	-
Pentane	Colorless Liquid	1	X	X	X	-	-	-	-	-	1	-	1	-	-	-	-	-	-	-	-
Pentanol (Methyl Propyl Carbinol)	Colorless Liquid	1	1	1	1	-	-	-	-	1	1	-	1	-	-	-	-	-	-	-	-
Pentanone (Methyl Propyl Ketone)	Water White Liquid	1	-	-	2	X	-	X	X	2	X	X	-	X	-	-	-	-	-	-	-
Pentasol (Amyl alcohols, primary and secondary)	Liquid	1	2	2	2	2	2	2	2	2	1	2	1	1	2	1	1	1	1	1	-
Perchloric Acid (70%)	70% or Less with H2O	1	2	1	-	-	2	2	2	2	1	2	-	X	X	-	2	1	-	-	1
Perchloroethylene	Colorless Liquid	1	2	-	X	X	X	X	X	X	1	X	2	2	X	1	1	1	-	X	-
Petroleum Coke	Solid Pellets	-	-	-	-	-	-	1	-	-	-	-	-	-	-	-	-	-	-	-	-
Petroleum Distillate	Liquid	1	-	-	-	-	-	-	-	-	1	-	-	-	-	-	-	-	-	-	-
Petroleum Ether (Naphtha)	Liquid	1	1	-	X	2	X	X	X	X	1	X	1	-	X	2	1	1	-	1	-
Petroleum Naphtha (Toluene/cyclohexane/xylene)	Liquid	1	X	X	X	X	X	X	X	X	1	X	X	X	X	-	-	-	-	-	-
Petroleum Naphtha Flash Point Over 200 Degrees	Liquid	1	-	-	-	-	-	-	-	-	1	-	-	-	-	-	-	-	-	-	-
Petroleum Oils (Refined)	Liquid	1	1	1	X	1	X	X	2	X	1	2	-	1	1	-	-	-	-	-	-
Petroleum Oils (Sour)	Liquid	1	1	1	X	1	X	X	2	X	1	X	-	-	2	-	-	-	-	-	-
Petroleum Paraffin Wax	Solid with low Melt Points	1	2	2	X	-	-	-	-	-	1	-	-	-	-	-	-	-	-	-	-

TABLE OF CONTENTS

ABOUT GATES

HYDRAULIC HOSE

HYDRAULIC HOSE COUPLINGS

ENGINEERING AND TECHNICAL DATA

CHEMICAL RESISTANCE TABLE



TABLE OF CONTENTS

ABOUT GATES

HYDRAULIC HOSE

HYDRAULIC HOSE COUPLINGS

ENGINEERING AND TECHNICAL DATA

CHEMICAL	FORM (AT ROOM TEMPERATURE UNLESS OTHERWISE STATED)	GATES HOSE / POLYMERS														COUPLINGS					
		Teflon®	XLPE	UHMWPE	EPDM	NR	SBR	NR	CR	Butyl	Fluorocarbon	Hypalon®	CPE	Nylon	PVC	Iron/Carbon Steel	Stainless Steel 304	Stainless Steel 316	Aluminum	Brass	Polypro
Phenol (Carbolic Acid)	White or Pink Crystals	1	2	-	2	X	X	X	X	2	1	X	1	X	X	X	1	1	2	X	-
Phenol Acid	95% or less with H2O	1	2	2	2	X	X	X	X	2	1	X	1	X	X	X	1	1	1	1	X
Phenolates	-	1	-	-	-	X	-	-	X	-	2	X	-	2	-	-	-	-	-	-	-
Phenolsulfonic Acid	Yellow to Brown Liquid	1	-	-	-	-	-	-	-	-	1	-	-	-	-	-	-	-	-	-	-
Phenothiazine	Greenish Powder or Flakes	-	-	-	-	-	-	1	-	-	-	-	-	-	-	-	-	-	-	-	-
Phenyl Acetate	Water White Liquid	1	-	-	-	-	-	-	-	-	-	-	-	-	-	-	-	-	-	-	-
Phenyl Chloride (Chlorobenzene)	Clear Volatile Liquid	1	2	-	X	X	X	X	X	X	1	X	X	X	X	1	1	1	1	1	X
Phenylenediamine (ortho)	Colorless to Red Solid Needles	-	-	-	-	-	-	1	-	-	-	-	-	-	-	-	-	-	-	-	-
Phorone (Diisopropylidene Acetone)	Yellow Liquid	1	1	-	2	X	X	X	X	2	X	X	-	-	-	1	1	1	1	1	-
Phosgene (Carbonyl Chloride)	Gas, Liquid 60 PSI @ 120°F (49°C)	1	X	X	X	X	X	X	X	2	1	X	-	2	-	-	-	-	-	-	-
Phosphate Ester Hydraulic Fluid	Liquid	1	1	1	1	X	X	X	X	-	-	X	-	2	-	-	-	-	-	-	-
Phosphate Rock	Solid	-	-	-	-	-	-	1	-	-	-	-	-	-	-	-	-	-	-	-	-
Phosphate, Trisodium	In Water	1	1	1	-	-	-	-	-	-	1	-	-	-	-	-	-	-	-	-	-
Phosphoric Acid (100%)	Crystals	1	2	X	2	-	-	-	-	-	1	-	-	-	-	-	-	-	-	-	-
Phosphoric Acid (35% or less)	Colorless Liquid	1	1	1	1	2	2	2	2	2	1	1	1	-	-	X	1	1	X	2	1
Phosphoric Acid (50%)	Colorless Liquid	1	1	1	1	2	2	2	2	2	1	1	1	X	X	X	1	1	X	2	1
Phosphoric Acid (75%)	Colorless Liquid	1	2	1	2	-	-	-	-	-	1	1	1	X	X	X	2	2	X	X	1
Phosphoric Acid (85%)	Syrupy Liquid	1	2	1	2	X	X	X	X	X	1	1	1	X	X	X	2	2	X	X	1
Phosphoric Acid (90%)	Syrupy Liquid	1	2	1	2	-	-	-	-	-	1	-	-	-	-	-	-	-	-	-	-
Phosphoric Acid, Spent	Liquid	1	1	-	1	-	-	-	-	-	1	-	-	-	-	-	-	-	-	-	-
Photographic, Developers	-	1	-	-	-	-	-	-	-	-	-	-	-	-	-	-	-	-	-	-	-
Photographic, Emulsions	Liquid	1	-	-	-	-	-	-	-	-	-	-	-	-	-	-	-	-	-	-	-
Photographic, Fixing Solutions	Liquid	1	-	-	-	-	-	-	-	-	-	-	-	-	1	-	-	-	-	-	-
Phthalic Acid	Colorless Crystals	-	-	-	-	-	-	1	-	-	-	-	-	-	-	-	-	-	-	-	-
Phthalic Acid (50%)	Colorless Liquid	1	-	1	-	-	-	-	-	-	-	-	-	-	-	-	-	-	-	-	-
Phthalic Anhydride, Molten	White Crystalline Solid	-	-	X	-	-	-	-	-	-	-	-	-	-	-	-	-	-	-	-	-
Picric Acid (Solution)	In Water	1	2	2	2	-	-	-	-	-	1	-	-	-	-	X	1	1	X	X	1
Picric Acid (Trinitrophenol)	Yellow Crystals	1	2	2	2	2	2	2	2	2	1	2	-	X	1	X	1	1	X	X	1
Pine Oil	Colorless to Amber Liquid	1	1	-	X	2	X	X	-	X	2	X	2	-	-	-	-	-	-	-	-
Pine Tar	Viscous Brown to Black Liquid	1	2	-	-	-	-	-	-	-	1	-	-	-	-	-	-	-	-	-	-
Pinene	Colorless Transparent Liquid	1	1	-	X	2	X	X	X	X	1	-	2	1	X	1	1	1	-	-	-
Piperazine Hydrochloride Solution (34%)	In Water	1	1	-	-	2	-	-	-	-	-	-	-	-	-	-	-	-	-	-	-
Pitch	In Aromatic Hydrocarbons	1	2	X	X	2	X	X	X	X	1	X	-	1	X	-	-	-	-	-	-
Plating Solution Chrome Under 120°F (49°C)	Liquid	1	1	-	2	-	-	-	-	2	2	-	-	X	X	-	X	X	-	-	1
Pluronic (Block Polymer with Hydroxyl by BASF)	Liquid	1	1	1	1	-	-	-	-	-	1	-	-	-	-	-	-	-	-	-	-
Polyester Plastic	-	1	1	-	-	-	-	-	-	-	2	-	-	2	-	-	-	-	-	-	-
Polyethylene Glycol	Colorless Liquid to glassy Solid	1	-	-	1	2	-	1	1	1	1	1	-	2	2	-	-	-	-	-	-
Polyethylene Plastic	Solid Beads	-	-	-	-	-	-	1	-	-	-	-	-	-	-	-	-	-	-	-	-
Polypropylene Glycol	Liquid	1	1	-	1	1	-	1	1	1	1	1	-	-	-	-	-	-	-	-	-
Polypropylene Plastic	Solid Beads	-	-	-	-	-	-	1	-	-	-	-	-	-	-	-	-	-	-	-	-
Polystyrene Plastic	Solid Beads	-	-	-	-	-	-	1	-	-	-	-	-	-	-	-	-	-	-	-	-
Polyurethane Foam Under 125°F (52°C)	-	1	1	-	2	-	-	-	-	2	2	-	-	-	-	-	-	-	-	-	-
Polyvinyl Acetate - Emulsions	Emulsion	1	-	-	1	1	-	1	2	1	-	1	-	-	-	-	-	-	-	-	-
Potash (Potassium Carbonate) Aqueous Solution	Liquid	1	1	-	1	-	1	1	1	1	1	1	-	1	1	2	1	1	-	X	1
Potassium Acetate	White Powder	1	1	-	2	2	2	2	2	2	X	2	1	-	1	-	1	1	-	-	1
Potassium Bicarbonate	Colorless crystal or white Powder	1	1	-	1	1	1	1	1	1	1	1	-	1	1	-	-	-	-	-	-
Potassium Bisulfate	Colorless crystal	1	1	-	1	1	1	1	1	1	1	1	1	-	1	-	-	-	-	-	-
Potassium Bromate	White Crystal or Powder	1	-	-	-	-	-	-	-	-	-	-	-	-	1	-	-	-	-	-	1
Potassium Bromide	White Crystals or Powder	1	1	-	1	1	1	1	1	1	1	1	-	1	1	-	-	-	-	-	-
Potassium Carbonate	White granular Powder	1	1	-	1	1	1	1	1	1	1	1	1	1	1	2	1	1	-	X	1
Potassium Carbonate, Liquid	Colorless to Cloudy Liquid	1	1	-	1	1	1	1	1	1	1	1	-	1	1	2	1	1	-	X	1
Potassium Chlorate	Colorless to white Powder	1	-	-	-	-	-	-	-	-	-	-	-	2	1	-	-	-	-	-	-

CHEMICAL RESISTANCE TABLE



CHEMICAL	FORM (AT ROOM TEMPERATURE UNLESS OTHERWISE STATED)	GATES HOSE / POLYMERS														COUPLINGS					
		Teflon®	XLPE	UHMWPE	EPDM	NR	SBR	NR	CR	Butyl	Fluorocarbon	Hypalon®	CPE	Nylon	PVC	Iron/Carbon Steel	Stainless Steel 304	Stainless Steel 316	Aluminum	Brass	Polypro
Potassium Chloride	Colorless to white Solid	1	-	-	-	-	-	-	-	-	-	-	1	1	1	-	-	-	-	-	-
Potassium Chloride, Dry	White Solid	1	1	-	1	1	1	1	1	1	1	1	-	1	1	-	-	-	-	-	-
Potassium Chromate	Yellow Crystal	1	2	-	2	X	X	X	2	2	1	2	1	2	1	-	-	-	-	-	1
Potassium Cuprocyanide	White Crystalline Solid	1	-	-	1	1	1	1	1	1	1	1	-	2	1	-	-	-	-	-	1
Potassium Cyanide	White Crystal	1	-	-	-	-	-	-	-	-	-	-	1	-	-	-	-	-	-	-	-
Potassium Dichromate	White Crystalline Powder	1	-	-	-	-	-	-	-	-	-	-	1	2	1	-	-	-	-	-	-
Potassium Ferrocyanide	Yellow Crystal or Powder	1	-	-	-	-	-	-	-	-	-	-	-	-	1	-	-	-	-	-	1
Potassium Fluoride	White Crystalline Powder	1	-	-	-	-	-	-	-	-	-	-	-	-	1	-	-	-	-	-	1
Potassium Hydrate	White Solid	1	-	-	2	2	2	2	2	2	1	X	1	-	2	2	-	-	-	-	-
Potassium Hydroxide (45% Caustic Potash)	Colorless to Cloudy Liquid	1	1	1	2	2	2	2	-	1	2	-	1	1	1	-	-	-	-	-	-
Potassium Hydroxide, Liquid	Colorless to Cloudy Liquid	1	1	-	1	2	2	2	2	1	X	2	-	X	X	-	-	-	-	-	-
Potassium Iodide	White Solid	1	-	-	1	1	-	-	1	-	1	1	-	-	1	-	-	-	-	-	2
Potassium Nitrate	Colorless to white Solid	1	-	-	-	-	-	-	-	-	-	-	1	1	1	-	-	-	-	-	-
Potassium Permanganate	Dark purple Crystal	1	1	-	-	-	-	-	-	-	-	-	X	X	-	-	-	-	-	-	-
Potassium Persulfate	White Crystal	1	-	-	-	-	-	-	-	-	-	-	-	-	1	-	-	-	-	-	-
Potassium Phosphate	Colorless to white Crystal	1	-	-	1	-	-	-	1	-	1	1	-	-	-	-	-	-	-	-	-
Potassium Silicate, Other Than Dry	-	1	1	-	1	1	2	-	1	-	1	-	-	-	-	-	-	-	-	-	-
Potassium Sulfate	White Crystal or Powder	1	-	-	-	-	-	-	-	-	-	-	1	1	1	-	-	-	-	-	-
Potassium Sulfide	Red or yellow Crystal or Solid	1	1	-	1	1	-	-	1	1	1	2	-	-	-	-	-	-	-	-	-
Potassium Sulfite	White Crystal or Powder	1	-	-	-	-	-	-	-	-	-	-	1	-	2	-	-	-	-	-	-
Potassium Thiosulfate	Colorless crystal	1	-	-	1	-	-	-	1	-	1	1	-	-	1	-	-	-	-	-	-
Primatol A, S, P (Ag Spray)	Liquid	1	-	-	-	-	-	-	-	-	-	-	-	-	-	-	-	-	-	-	-
Propane Gas	Colorless Gas	CONTACT DENVER PRODUCT APPLICATION																			
Propanediol	Colorless Liquid	1	1	-	1	1	-	-	X	1	1	2	-	-	-	-	-	-	-	-	-
Propanol (Propyl Alcohol)	Colorless Liquid	1	1	1	1	-	-	-	-	1	1	-	1	1	2	-	-	-	-	-	-
Propionic Acid	Colorless Oily Liquid	1	1	1	2	X	2	2	X	2	1	2	-	-	-	1	1	-	-	-	-
Propyl Acetate	Colorless Liquid	1	1	1	-	-	-	-	-	X	-	2	-	-	-	-	-	-	-	-	-
Propyl Alcohol (Propanol)	Colorless Liquid	1	1	1	1	-	-	-	-	1	1	-	1	1	2	-	-	-	-	-	-
Propyl Aldehyde	White-water Liquid	1	-	-	-	X	-	X	-	2	X	X	-	-	-	-	-	-	-	-	-
Propyl Chloride	Colorless Liquid	1	-	-	-	X	-	X	-	X	2	X	-	-	-	-	-	-	-	-	-
Propylene	Colorless Gas	1	-	-	X	X	X	X	X	X	1	X	-	-	-	-	-	-	-	-	-
Propylene Diamine	Colorless Liquid	1	-	-	-	2	-	2	-	2	-	X	-	-	-	-	-	-	-	-	-
Propylene Dichloride (Dichloropropane)	Colorless Liquid	1	-	-	X	X	X	X	X	X	2	X	-	-	-	-	-	-	-	-	-
Propylene Glycol	Liquid	1	1	-	1	1	1	1	1	1	1	1	1	1	2	1	-	-	-	-	-
Propylene Oxide	Colorless Liquid	-	-	-	-	-	-	-	-	-	-	-	-	-	-	-	-	-	-	-	-
Purina Insecticide	-	1	1	-	2	X	-	-	X	2	2	-	-	2	-	1	1	1	1	2	-
Puropale RX Oils	Liquid	1	1	-	X	1	-	-	-	X	-	-	-	1	2	1	1	1	1	1	-
Pydraul 10E, 29E-LT, 30E, 60, 65E, 115SE	Liquid	1	1	-	2	X	-	-	-	2	-	-	2	-	X	1	1	1	1	1	-
Pydraul 135	Liquid	1	1	-	-	X	-	-	-	2	1	-	2	2	-	1	1	1	-	-	-
Pydraul 150	Liquid	1	1	-	2	X	X	X	X	2	1	X	2	2	X	1	1	1	1	1	-
Pydraul 280	Liquid	1	1	-	2	X	X	X	X	2	2	X	2	2	X	1	1	1	-	-	-
Pydraul 312	Liquid	1	1	-	X	X	X	X	X	X	1	-	2	1	X	1	1	1	-	-	-
Pydraul 50E	Liquid	1	1	-	2	-	-	-	-	2	2	-	2	1	X	-	-	-	-	-	-
Pydraul 540	Liquid	1	1	-	X	X	X	X	X	X	1	X	2	X	X	1	1	1	-	-	-
Pydraul 625	Liquid	1	1	-	2	X	X	X	X	2	1	X	2	2	X	1	1	1	-	-	-
Pydraul A-200	Liquid	1	1	-	X	X	X	X	X	X	1	X	2	2	X	1	1	1	-	-	-
Pydraul F-9	Liquid	1	2	-	2	X	X	X	X	2	1	X	2	2	-	1	1	1	-	-	-
Pyrene (Carbon Tetrachloride)	Colorless Liquid	1	2	X	X	X	X	X	X	X	1	X	2	1	X	X	2	2	X	2	X
Pyrethrum	Liquid	1	-	-	-	-	-	-	-	-	-	-	-	-	2	-	-	-	-	-	-
Pyridine (50%)	-	1	2	-	-	-	-	-	X	-	X	X	-	-	X	-	1	1	1	1	-
Pyrogard 160, 230, 630	Liquid	1	1	-	-	-	-	-	-	2	-	-	-	-	-	1	1	1	-	-	-
Pyrogard 51, 53, 55	Liquid	1	1	-	2	X	-	-	-	2	-	-	-	-	-	1	1	1	-	-	-

TABLE OF CONTENTS

ABOUT GATES

HYDRAULIC HOSE

HYDRAULIC HOSE COUPLINGS

ENGINEERING AND TECHNICAL DATA

CHEMICAL RESISTANCE TABLE



TABLE OF CONTENTS

ABOUT GATES

HYDRAULIC HOSE

HYDRAULIC HOSE COUPLINGS

ENGINEERING AND TECHNICAL DATA

CHEMICAL	FORM (AT ROOM TEMPERATURE UNLESS OTHERWISE STATED)	GATES HOSE / POLYMERS														COUPLINGS					
		Teflon®	XLPE	UHMWPE	EPDM	NR	SBR	NR	CR	Butyl	Fluorocarbon	Hypalon®	CPE	Nylon	PVC	Iron/Carbon Steel	Stainless Steel 304	Stainless Steel 316	Aluminum	Brass	Polypro
Pyrogard C, D	Liquid	1	1	-	X	1	-	-	-	X	-	-	1	2	1	1	1	1	1	1	-
Pyronal (Transformer Oil)	Liquid	1	1	-	-	-	-	-	-	-	1	-	-	-	-	-	-	-	-	-	-
Q																					
Quenching Oil	Liquid	1	-	-	-	2	-	-	2	-	-	-	-	-	-	1	1	1	1	-	-
Quintolubric 822	Liquid	1	1	-	2	1	-	-	2	X	1	-	1	-	1	1	1	1	1	1	-
R																					
Ramrod (Ag Spray)	-	1	1	-	-	-	-	-	-	-	-	-	1	-	1	1	1	1	1	1	-
Rando Oils	Liquid	1	1	-	X	1	-	-	-	X	-	-	1	-	1	1	1	1	1	1	-
Rape Seed Oil	Brownish to yellow Liquid	1	1	-	2	-	-	-	-	2	-	X	-	2	-	1	1	1	1	1	-
Red Oil (Commercial Oleic Acid) (MIL-5606)	Liquid	1	2	2	2	2	X	X	2	2	2	X	2	1	2	2	2	1	1	2	1
Refined Wax (Petroleum)	-	1	1	-	-	1	X	X	2	-	1	-	1	-	1	1	1	-	1	-	-
Regal Oils R&O	Liquid	1	1	-	X	1	-	-	-	X	-	-	1	2	1	1	1	1	1	1	-
Richfield "A" Weed Killer	-	1	1	-	X	2	X	X	X	X	2	X	-	2	-	-	-	-	-	-	-
Road Paving Compound	-	-	-	X	-	-	-	-	-	-	-	-	-	-	-	-	-	-	-	-	-
Road Tar	-	-	-	2	-	-	-	-	-	-	-	-	-	-	-	-	-	-	-	-	-
Rubilene Oils	Liquid	1	1	-	X	1	-	-	-	X	-	-	1	2	-	-	-	-	-	-	-
S																					
Salicylic Acid	White Powder	1	1	1	2	X	2	2	-	2	2	-	1	1	-	1	1	2	-	-	-
Salt Water (Sea Water)	Liquid	1	1	-	1	2	2	X	2	1	1	2	-	1	1	2	1	1	-	2	-
Sauerkraut	-	1	-	-	-	-	-	-	-	-	-	-	-	2	-	-	-	-	-	-	-
Sea Water	Colorless Liquid	1	1	-	1	2	2	X	2	1	1	2	-	1	1	2	1	1	-	2	-
Sevin	-	1	2	-	2	-	-	-	-	-	-	-	-	1	-	-	-	-	-	-	-
Sewage	Sludge	1	1	1	1	2	2	X	2	-	-	2	1	1	2	X	1	1	2	1	-
Shampoo	Liquid	1	-	1	-	-	-	-	-	-	-	-	-	-	-	-	-	-	-	-	-
Shellac	Orange to colorless flake	1	-	X	-	-	-	-	-	-	-	-	1	-	-	-	-	-	-	-	-
Shortening	-	1	-	-	X	1	-	-	-	-	-	-	-	-	-	-	-	-	-	-	-
Silicate of Soda	Brownish or yellow Liquid	1	1	-	1	1	-	1	1	1	1	1	-	-	-	-	-	-	-	-	-
Silicone Greases	Liquid	1	2	-	-	2	-	-	2	-	2	2	-	1	2	1	1	1	-	1	-
Silicone Oils	Liquid	1	2	-	-	2	-	-	2	-	2	2	-	1	2	1	1	1	-	1	-
Silver Cyanide	White Powder	1	1	-	-	-	-	-	1	-	-	-	-	1	-	-	-	-	-	-	1
Silver Nitrate	Colorless crystal	1	1	-	1	1	1	1	1	1	1	1	1	1	2	2	1	1	1	2	-
Skydrol 500A & 7000	Liquid	1	1	-	1	X	X	X	X	2	X	X	2	1	X	1	1	1	1	-	-
Soap Oil	Liquid	1	1	2	-	X	-	-	X	-	X	-	-	-	1	1	1	-	-	-	-
Soap Solutions	Liquid	1	1	1	1	1	X	X	2	1	1	1	1	1	1	1	1	1	1	1	-
Soap, Liquid	Liquid	1	1	-	1	2	2	1	2	1	2	1	1	-	2	2	1	1	1	-	-
Soda Ash (Sodium Carbonate)	Grayish Powder	1	1	-	1	1	1	1	1	1	1	1	1	1	1	1	1	1	X	2	1
Soda Water	Liquid	1	-	-	-	-	-	-	-	-	-	-	-	1	1	-	-	-	-	-	-
Sodium Acetate	Colorless crystal	1	1	-	2	X	2	2	X	2	X	X	1	1	1	1	1	1	1	1	-
Sodium Aluminate Solution	Colorless to cloudy Liquid	1	1	-	1	1	2	2	1	1	1	1	-	2	2	-	-	-	-	-	-
Sodium Benzoate	White Crystals or Powder	1	-	-	-	-	-	-	-	-	-	-	-	1	-	-	-	-	-	-	1
Sodium Bicarbonate	White Crystal or Powder	1	1	-	1	1	1	1	1	1	1	1	1	1	1	2	1	1	-	2	-
Sodium Bichromate Solution	Red to clear Liquid	1	1	-	1	2	2	2	2	1	1	2	-	2	2	-	-	-	-	-	-
Sodium Bisulfate (Niter Cake)	Colorless Crystals to White Lumps	1	1	-	1	1	1	1	1	1	1	1	1	1	1	X	1	1	X	X	-
Sodium Bisulfite	White Crystals or Powder	1	1	-	1	1	1	1	1	1	1	1	1	1	1	1	1	1	-	-	-
Sodium Borate (Borax)	White Crystals	1	1	-	1	1	1	1	1	1	1	1	1	1	1	2	1	1	-	2	1
Sodium Carbonate (Soda Ash)	Grayish Powder	1	1	-	1	1	1	1	1	1	1	1	1	1	1	1	1	1	X	2	1
Sodium Chlorate	Colorless Crystals	1	-	-	1	1	1	1	2	2	1	1	-	1	1	-	-	-	-	-	1
Sodium Chloride	Colorless to white Crystals	1	1	1	1	1	1	1	1	1	1	1	1	1	1	1	2	2	1	X	X
Sodium Chlorite Solution	Colorless to cloudy Liquid	2	-	-	X	X	2	2	X	2	X	2	-	X	2	-	-	-	-	-	-
Sodium Chromate	Yellow, translucent Crystals	1	-	-	-	1	2	2	1	2	1	X	-	2	2	-	-	-	-	-	-
Sodium Cyanide	In Water	1	1	-	1	1	1	1	1	1	1	1	1	1	1	2	1	1	X	X	-
Sodium Cyanide	White Crystalline Powder	1	1	-	1	1	1	1	1	1	1	1	1	1	1	2	1	1	X	X	-

CHEMICAL RESISTANCE TABLE



CHEMICAL	FORM (AT ROOM TEMPERATURE UNLESS OTHERWISE STATED)	GATES HOSE / POLYMERS														COUPLINGS					
		Teflon®	XLPE	UHMWPE	EPDM	NR	SBR	NR	CR	Butyl	Fluorocarbon	Hypalon®	CPE	Nylon	PVC	Iron/Carbon Steel	Stainless Steel 304	Stainless Steel 316	Aluminum	Brass	Polypro
Sodium Dichromate	Red to red-orange Crystals	1	-	-	1	1	2	2	2	1	1	2	1	-	1	-	-	-	-	-	1
Sodium Ferricyanide	Ruby-red Crystals	1	-	-	-	-	-	-	-	-	-	-	-	-	1	-	-	-	-	-	1
Sodium Ferrocyanide	Yellow, transparent Crystals	1	-	-	-	-	-	-	-	-	-	-	-	1	-	-	-	-	-	-	1
Sodium Fluoride (70%)	White Liquid	1	1	1	2	-	2	2	-	2	-	-	-	1	-	-	2	-	-	-	-
Sodium Hydrate	White Solid	1	2	-	1	2	2	2	2	2	2	2	-	2	2	-	-	-	-	-	-
Sodium Hydrochlorite	Pale greenish Liquid	1	2	-	2	X	2	X	X	2	1	1	-	2	2	-	-	-	-	-	-
Sodium Hydrosulfide	Colorless needles	1	-	-	-	-	-	-	-	-	-	-	-	1	-	-	-	-	-	-	-
Sodium Hydrosulfite	Lemon colored Powder or flake	1	-	-	-	-	-	-	-	-	-	-	-	2	-	-	-	-	-	-	-
Sodium Hydroxide (10%)	Colorless Liquid	1	1	1	-	-	-	-	-	-	1	-	1	-	-	-	-	-	-	-	-
Sodium Hydroxide (40%)	Colorless Liquid	1	1	1	2	2	1	1	1	2	1	1	1	X	-	2	1	1	X	X	-
Sodium Hydroxide (50% Under 212°F (100°C))	Colorless Liquid	1	1	2	2	-	-	-	-	-	X	-	-	-	-	-	-	-	-	-	-
Sodium Hydroxide (50%, Under 115°F (46°C))	Colorless Liquid	1	1	2	2	X	1	1	2	1	X	1	1	X	-	2	2	2	X	X	-
Sodium Hydroxide (50%, Under 180°F (82°C))	Colorless Liquid	1	1	2	2	X	X	X	2	2	X	2	1	X	-	X	2	2	X	X	-
Sodium Hydroxide (60%)	White Liquid	1	2	1	2	X	2	2	2	2	X	2	1	X	-	X	2	2	X	X	-
Sodium Hydroxide 25%	Colorless Liquid	1	1	1	2	2	1	1	1	2	1	1	X	-	X	2	2	X	X	-	-
Sodium Hypochlorite (20%)	White Liquid	1	2	1	1	X	X	X	X	-	X	1	1	2	1	X	X	2	X	X	-
Sodium Hypochlorite (5%)	White Liquid	1	2	1	1	X	X	X	-	-	1	1	1	1	1	X	X	2	X	X	-
Sodium Hyposulfate	Large, transparent Crystals	1	-	-	-	-	-	-	-	-	-	-	-	1	-	-	-	-	-	-	-
Sodium Metallic	Silver Solid	2	-	-	1	2	-	-	-	-	-	-	-	-	-	-	-	-	-	-	-
Sodium Metaphosphate	Colorless Crystals to white Powder	1	1	-	2	2	2	2	2	2	2	2	1	1	1	X	1	1	1	X	-
Sodium Nitrate	Colorless crystal	1	1	-	2	X	X	X	X	2	-	2	1	1	1	1	2	2	2	2	-
Sodium Perborate	White, amorphous Powder	1	1	-	2	X	X	X	X	2	-	X	-	2	-	X	1	1	1	X	-
Sodium Peroxide	Yellowish white Powder	1	1	2	-	-	-	-	1	1	1	1	2	X	1	X	1	1	1	X	-
Sodium Phosphate	Colorless Crystals to white Powder	1	1	-	2	-	2	2	X	2	-	-	1	1	1	-	1	1	X	X	-
Sodium Silicate	Lumps of greenish glass	1	1	-	1	1	1	1	1	1	1	1	1	1	1	-	-	-	-	-	1
Sodium Sulfate	White Crystals or Powder	1	1	-	1	1	2	2	1	1	1	1	1	1	1	-	-	-	-	-	1
Sodium Sulfate Decahydrate (Glauber's Salt)	Crystals or Powder	1	-	-	1	-	1	1	-	-	-	-	-	-	-	-	-	-	-	-	-
Sodium Sulfhydrate	Colorless to cloudy Liquid	1	2	-	1	2	X	2	2	2	2	2	-	2	2	-	-	-	-	-	-
Sodium Sulfide	Yellow/Brick red flakes or Crystals	1	1	-	1	1	2	2	1	1	1	1	1	1	1	-	-	-	-	-	1
Sodium Sulfide Solution	Colorless to cloudy Liquid	1	2	-	1	2	-	2	2	1	2	2	-	X	-	-	-	-	-	-	1
Sodium Sulfite	White Crystals or Powder	1	1	-	2	2	2	2	2	2	-	2	1	1	1	1	1	1	-	-	-
Sodium Sulfite Solution	Colorless to cloudy Liquid	1	2	-	1	2	-	2	2	1	2	2	-	X	-	1	1	1	-	-	-
Sodium Sulphhydrate	Colorless needles	1	2	-	1	2	-	-	2	1	2	2	-	2	2	-	-	-	-	-	-
Sodium Thiocyanate Solution	Colorless to cloudy Liquid	1	1	-	1	1	2	-	1	2	1	2	-	-	-	-	-	-	-	-	-
Sodium Thiosulfate (HPO)	White Powder	1	1	-	1	1	1	1	1	1	-	1	1	1	1	X	1	1	2	X	-
Sodium Tripolyphosphate (STPP)	White Powder	1	2	-	-	-	-	-	-	2	X	-	-	-	-	-	1	1	X	X	-
Solnus Oils	Liquid	1	1	-	X	1	-	-	-	X	-	-	-	1	1	1	1	1	1	1	-
Sour Crude Oil	Liquid	-	-	-	-	-	-	-	-	-	-	-	-	X	-	-	-	-	-	-	-
Soybean Oil	Pale yellow oil	1	1	1	X	2	X	X	2	2	1	2	-	1	2	1	1	1	-	-	-
Spent Acid	Liquid	1	2	2	X	X	X	X	X	X	1	2	X	X	X	-	1	1	-	-	-
Stannic Chloride	Colorless, fuming Liquid	1	1	-	-	2	2	2	X	X	1	X	1	X	2	X	-	-	-	X	-
Stannic Sulfide	Yellow to brown Powder	1	2	-	-	2	-	2	-	2	-	2	-	-	-	-	-	-	-	-	-
Stannous Chloride (Under 150°F)	White Mass	1	1	-	2	1	1	1	1	1	1	1	1	X	1	-	-	-	-	-	1
Starch	White amorphous Powder	1	1	-	1	2	1	1	2	-	1	1	-	1	1	-	-	-	-	-	-
Starch gum (Dextrin)	Yellow or White Powder	1	1	-	1	1	-	-	1	X	1	-	-	1	1	-	1	1	-	-	1
Stauffer Jet 1	Liquid	1	1	-	-	-	-	-	-	-	-	-	-	-	-	1	1	1	1	1	-
Stauffer Jet 2	Liquid	1	1	-	-	-	-	-	-	-	-	-	-	-	-	1	1	1	1	1	-
Steam	Gas	USE STEAM HOSE ONLY																			
Stearic Acid (Octadecanoic Acid)	Colorless Waxy Solid	1	1	1	2	2	2	2	2	2	1	2	1	1	1	X	2	1	X	X	-
Stearin	Colorless crystal or Powder	1	-	-	-	-	-	-	-	-	-	-	-	2	-	-	-	-	-	-	-
Stoddard Solvent	Clear petroleum distillate	1	2	-	X	2	X	X	-	X	1	-	1	1	2	2	1	1	-	1	-
STPP (Sodium Tripolyphosphate)	White Powder	1	2	-	2	-	2	2	-	2	X	-	-	-	-	-	2	1	X	X	-

TABLE OF CONTENTS

ABOUT GATES

HYDRAULIC HOSE

HYDRAULIC HOSE COUPLINGS

ENGINEERING AND TECHNICAL DATA

CHEMICAL RESISTANCE TABLE



TABLE OF CONTENTS

ABOUT GATES

HYDRAULIC HOSE

HYDRAULIC HOSE COUPLINGS

ENGINEERING AND TECHNICAL DATA

CHEMICAL	FORM (AT ROOM TEMPERATURE UNLESS OTHERWISE STATED)	GATES HOSE / POLYMERS														COUPLINGS					
		Teflon®	XLPE	UHMWPE	EPDM	NR	SBR	NR	CR	Butyl	Fluorocarbon	Hypalon®	CPE	Nylon	PVC	Iron/Carbon Steel	Stainless Steel 304	Stainless Steel 316	Aluminum	Brass	Polypro
Straight Synthetic Oils	Liquid	1	-	-	-	-	-	-	-	-	-	-	-	1	2	-	-	-	-	-	-
Styrene (Monomer)	Colorless Oily Liquid	1	2	-	X	X	X	X	-	X	2	-	2	2	-	2	X	2	X	2	-
Sucrose Solutions	Liquid	1	1	-	-	1	1	1	1	1	-	1	-	-	-	1	1	1	-	-	-
Sugar, Liquid, Blended	Liquid	1	1	-	1	1	1	1	1	1	1	2	-	-	-	-	-	-	-	-	-
Sugar, Syrup	Liquid	1	1	-	1	1	1	1	1	1	1	2	-	-	-	-	-	-	-	-	-
Sulfamic Acid	In Water	1	1	1	2	X	X	X	-	2	1	2	1	X	X	-	-	-	-	-	-
Sulfamic Acid 10% Under 170°F (77°C)	Colorless Liquid	1	X	-	-	-	X	X	-	-	2	2	1	-	-	-	-	-	-	-	-
Sulfate Liquors Under 150°F (66°C)	-	1	-	-	-	-	-	-	-	-	-	-	-	1	1	-	-	-	-	-	1
Sulfur (Under 200°F (93°C))	Yellow Crystals	-	-	-	-	-	-	-	-	-	-	-	-	-	-	-	-	-	-	-	-
Sulfur Chloride	Yellow Oily Liquid	1	2	-	X	X	X	X	X	X	1	2	-	2	2	X	X	2	-	X	-
Sulfur Dioxide	Colorless Gas or Liquid	-	-	-	2	X	X	-	-	2	X	-	-	-	-	-	-	-	-	-	-
Sulfur Dioxide (Dry)	-	1	2	-	2	X	X	X	X	X	1	2	-	X	1	2	1	1	1	1	-
Sulfur Dioxide (Liquid)	Colorless Liquid	1	-	1	1	X	X	X	2	2	X	2	-	-	X	-	-	-	-	-	-
Sulfur Dioxide (Moist)	-	1	-	1	1	X	X	X	2	1	2	2	-	X	-	-	-	-	-	-	-
Sulfur Hexafluoride (Gas)	Colorless Gas	1	1	-	1	2	2	2	1	1	2	2	-	1	2	-	-	-	-	-	-
Sulfur Trioxide (Dry)	Solid	1	2	-	2	X	X	X	X	X	1	X	X	-	1	2	2	2	2	-	-
Sulfuric Acid (10%)	Colorless Water Solution	1	1	1	1	2	1	1	1	1	1	1	1	X	-	-	X	X	2	X	X
Sulfuric Acid (100%)	Colorless Liquid	1	X	X	X	X	X	X	X	X	2	X	X	-	-	2	X	2	X	X	-
Sulfuric Acid (30%)	Colorless Water Solution	1	1	1	1	2	2	2	1	1	1	1	1	X	-	X	X	2	X	X	-
Sulfuric Acid (50%)	Colorless Water Solution	1	1	1	1	X	X	X	2	1	1	1	1	X	-	X	X	2	X	X	-
Sulfuric Acid (60%) (48.5 deg Baume)	Colorless Liquid	1	1	1	1	X	X	X	X	1	1	1	1	X	-	X	X	2	X	X	-
Sulfuric Acid (75%)	Colorless to Brown Solution	1	1	1	2	X	X	X	X	2	1	2	2	X	-	X	X	2	X	X	-
Sulfuric Acid (88%) (64.7 deg Baume)	Colorless Liquid	1	2	1	X	X	X	X	X	X	1	X	X	X	-	X	X	2	X	X	-
Sulfuric Acid (93%)	Colorless to Brown Oily Liquid	1	X	1	X	X	X	X	X	X	1	X	X	X	-	X	X	2	X	X	-
Sulfuric Acid (96%)	Colorless Liquid	1	X	1	X	X	X	X	X	X	1	X	X	X	-	X	X	2	X	X	-
Sulfuric Acid (98%)	Colorless to Brown Oily Liquid	1	X	1	X	X	X	X	X	X	1	X	X	X	-	X	X	2	X	X	-
Sulfuric Acid, Fuming (Oleum)	Colorless to Dark Brown Oily Liquid	1	X	X	X	X	X	X	X	X	1	X	X	X	-	-	1	-	-	-	X
Sulfurous Acid (10%)	Colorless Liquid	1	1	1	1	X	X	X	-	2	1	1	1	-	1	-	X	2	1	X	X
Sulfurous Acid (75%)	Colorless Liquid	1	1	1	1	X	X	X	X	X	1	1	1	X	-	X	X	2	X	X	-
Sun R&O Oils	Liquid	1	1	-	X	1	-	-	-	X	1	-	-	1	2	1	1	1	1	1	-
Suntac HP Oils	Liquid	1	1	-	X	1	-	-	-	X	1	-	-	1	2	1	1	1	1	-	-
Suntac WR Oils	Liquid	1	1	-	X	1	-	-	-	X	1	-	-	1	2	1	-	1	1	-	-
Sunvis Oils 700, 800, 900	Liquid	1	1	-	X	1	-	-	-	X	1	-	-	1	2	1	1	1	-	-	-
Synthetic Oil (Citgo)	Liquid	1	1	-	X	-	-	-	-	X	-	-	-	1	2	1	1	1	-	-	-
Syrup	Viscous Liquid	1	1	-	-	-	1	1	2	-	1	-	-	-	-	-	1	1	-	-	-
T																					
Tall Oil	Black liquid	1	2	-	X	1	X	X	X	X	2	X	-	-	X	-	X	2	-	-	-
Tall Oil(Under 150°F (66°C))	Liquid	1	1	-	X	2	X	X	2	X	1	X	-	-	-	-	X	2	-	-	-
Tallow	White to clear Solid or Liquid	1	1	-	2	2	-	-	2	2	-	-	-	1	2	2	2	2	1	2	-
Tannic Acid	Faint Yellow Powder	1	1	1	1	X	2	2	2	1	1	2	1	1	1	2	1	1	2	X	-
Tannic Acid (10 %)	Yellow Liquid	1	1	-	-	X	2	2	2	X	1	2	1	1	1	2	1	1	2	X	-
Tar (Bituminous) Under 100°F (38°C)	-	1	1	2	X	2	X	X	2	X	1	-	X	-	-	1	1	1	1	2	-
Tar Oil	Yellow to dark brown Liquid	1	-	-	-	-	-	-	-	-	-	-	-	1	2	-	-	-	-	-	-
Tartaric Acid	White Crystalline Powder	1	1	1	1	2	2	2	2	1	1	1	1	-	-	-	2	2	2	-	-
TEA (Triethanolamine)	Colorless Viscous Liquid	1	1	-	1	2	2	2	2	2	X	2	1	-	2	-	1	1	-	1	-
TEL (Tetraethyl Lead)	Colorless Oily Liquid	1	2	-	X	2	X	X	X	X	1	X	-	2	1	-	-	-	-	-	-
Tellus Oils	Liquid	1	1	-	X	1	-	-	-	X	1	-	-	1	2	1	1	1	1	1	-
Tenol Oils	Liquid	1	1	-	X	1	-	-	-	X	1	-	-	1	2	1	1	1	1	-	-
Tergitol (Ethoxylates and Ethoxysulfates of Alcohol)	-	1	2	-	-	-	-	-	-	-	-	-	-	-	-	2	1	1	-	2	-
Terpineol	Colorless Liquid or Crystal	1	1	-	-	-	X	X	-	X	-	2	1	2	2	-	-	-	-	-	-
Tertiary Butyl Alcohol	Colorless Liquid or Crystal	1	2	-	-	2	-	-	-	-	1	-	-	-	-	-	-	-	-	-	-
Tetrachlorobenzene	White Crystal	1	-	-	-	-	-	-	-	-	2	-	-	-	-	-	-	-	-	-	-

CHEMICAL RESISTANCE TABLE



TABLE OF CONTENTS

ABOUT GATES

HYDRAULIC HOSE

HYDRAULIC HOSE COUPLINGS

ENGINEERING AND TECHNICAL DATA

CHEMICAL	FORM (AT ROOM TEMPERATURE UNLESS OTHERWISE STATED)	GATES HOSE / POLYMERS													COUPLINGS							
		Teflon®	XLPE	UHMWPE	EPDM	NR	SBR	NR	CR	Butyl	Fluorocarbon	Hypalon®	CPE	Nylon	PVC	Iron/Carbon Steel	Stainless Steel 304	Stainless Steel 316	Aluminum	Brass	Polypro	
V																						
Varnish	-	1	2	-	X	X	X	X	X	X	2	X	-	1	-	2	1	1	-	2	-	
Vegetable Oils	Liquids	1	-	1	2	-	X	X	2	X	-	1	1	1	2	1	1	1	1	-	-	
Versilube F-50, F-44	Liquid	1	-	-	2	2	2	2	2	2	1	2	-	1	2	1	1	1	1	1	-	
Vinegar	Brownish to colorless Liquid	1	1	-	-	2	2	2	2	2	1	X	2	-	1	X	2	1	X	X	-	
Vinyl Acetate	Colorless Liquid	1	1	X	X	X	X	X	X	2	X	X	1	-	-	-	1	2	1	2	-	
Vinyl Chloride (Monomer)	-	1	2	-	X	X	X	X	X	2	X	X	-	X	2	1	1	1	X	-	-	
Vinyl Chloride	Colorless Gas	1	1	-	-	-	-	-	-	-	1	-	-	-	-	-	-	-	-	-	-	
Vinyl Trichloride (Trichloroethane)	Colorless Liquid	1	-	-	X	X	X	X	X	X	1	X	X	X	X	-	-	-	-	-	-	
Vitrea Oils	Liquid	1	1	-	X	1	-	-	-	X	-	-	-	1	2	1	1	1	-	-	-	
VM&P Naptha (Mineral Spirits)	Colorless Liquid	1	1	-	X	1	X	X	-	X	1	X	-	1	-	1	1	1	2	1	-	
W																						
Waste Paint	Liquid to semi-Solid paste	1	-	-	-	-	-	-	-	-	-	-	-	-	-	-	-	-	-	-	-	
Water	Liquid	1	1	1	1	1	1	1	1	1	-	1	1	1	1	2	1	1	1	1	-	
Water (Brine)	Liquid	1	1	-	1	2	1	1	2	1	1	1	-	1	1	-	-	-	-	-	1	
Water (Deionized)	Liquid	1	-	1	-	-	-	-	-	-	1	-	-	-	-	-	-	-	-	-	-	
Water (Distilled)	Liquid	1	1	1	1	1	1	1	2	1	-	1	-	1	1	-	-	-	-	-	1	
Water (Potable)	Liquid	USE AQUARIUS HOSE ONLY										1										
Water Glycols	Liquid	1	1	1	-	-	-	-	-	-	-	-	-	1	1	-	-	-	-	-	-	
Water in Oil Emulsions	Liquid	1	1	1	-	-	-	-	-	-	-	-	-	1	1	-	-	-	-	-	-	
White & Bagley No. 2190 Cutting Oil	Liquid	1	-	-	-	-	-	-	-	-	-	-	-	-	-	-	-	-	-	-	-	
Wines	Liquid	1	2	-	X	X	X	X	X	X	1	X	1	1	-	2	2	2	1	-	-	
Wood Oil	Liquid	1	1	-	X	1	X	X	2	X	1	2	1	1	1	-	-	-	-	-	-	
X																						
Xylene (Dimethylbenzene)	Colorless Liquid	1	2	X	X	X	X	X	X	X	1	X	X	X	X	-	-	-	-	-	-	
Xylenol (Dimethylphenol)	White solid, liquid @ 68°F (20°C)	1	1	-	-	-	-	-	-	-	1	-	-	-	-	-	-	-	-	-	-	
Z																						
Zeric	-	1	1	-	X	1	-	-	-	X	-	-	-	2	2	-	-	-	-	-	-	
Zinc Acetate	White Crystal	1	1	-	2	X	2	2	X	2	X	X	-	X	1	1	1	1	1	1	-	
Zinc Chloride Solutions	Colorless to cloudy Liquid	1	1	-	-	1	2	2	1	2	1	1	1	1	2	X	2	1	X	X	-	
Zinc Chromate	Yellow Solid	1	1	-	-	-	-	-	-	-	-	1	1	-	-	-	1	1	-	-	-	
Zinc Hydrate	-	1	-	-	-	-	-	-	-	-	-	-	-	1	-	-	-	-	-	-	-	
Zinc Oxide	White or gray Powder	1	-	-	-	-	-	-	-	-	-	-	-	1	-	-	-	-	-	-	-	
Zinc Sulfate Solutions	Colorless to cloudy Liquid	1	1	-	2	2	X	X	2	2	-	2	1	2	2	X	2	1	X	X	-	



SELECTING THE CORRECT HOSE





HYDRAULIC HOSE ASSEMBLY AND INDUSTRIAL HOSE SELECTION CRITERIA

An effective way to remember hose selection criteria is to remember the word STAMP, if you want to select the proper hydraulic hose assembly extend this acronym to STAMPED.

STAMPED

- S = Size
- T = Temperature
- A = Application
- M = Medium
- P = Pressure
- E = Ends
- D = Delivery

Size

The **inside diameter** must be carefully chosen since an undersized hose diameter leads to increased pressure loss and heat generation by excessive turbulence of the hydraulic fluid. Oversizing the hose, however, adds unnecessary cost, weight and bulk.

To determine the replacement hose size, read the layline printing on the side of the original hose. If the original hose layline is painted over or worn off, cut the original hose and measure the inside diameter for size.

The hose **outside diameter** (O.D.) can be a critical factor when hose routing clamps are used or hoses are routed through bulkheads. Check individual hose specification tables for O.D.'s.

Temperature

Both fluid temperature and ambient temperature must be considered. The hose selected must be capable of withstanding the surrounding minimum and maximum temperature of the environment, as well as the maximum temperature of the system. When hoses are exposed to an extremely high ambient temperature or hot equipment parts, insulating sleeves or a heat shield to protect the hose are recommended.

Application

When designing a system or replacing a hose line, every aspect of the application has to be considered. Make sure all requirements of the application are fulfilled for the best fit. The type of equipment, working and surge pressures, environmental conditions, routing requirements and expected service life are the most obvious ones, but note there is much more that can impact the right choice of a hose assembly and optimal functioning of the system. Conditions such as ozone and chemical vapours, vibrations, movement of machine parts and unusual mechanical loads, electrical conductivity requirements, government and industry standards, excessive abrasion....

Medium

Some applications require specialised oils or chemicals to be conveyed through the system. Hose selection must assure compatibility of the hose tube, cover, couplings and 'O' rings with the fluid used. Attention is due to the chemical name(s) and state(s) – liquid, solid or gas, concentration. See page 291 on "Material to be conveyed" and the "Chemical resistance table" for further guidance.

Pressure

In the hose selection process it is essential to know the system pressure, including pressure spikes. Published working pressures of the hoses must be equal or greater than the system pressure. Pressure spikes greater than the published working pressure significantly shorten hose life.

SELECTING THE CORRECT HOSE

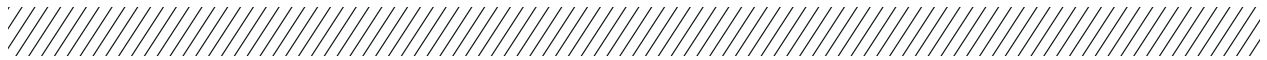

To minimise hose failure, the hydraulic hose has a build-in safety factor which is specified by the ratio between the burst pressure and the maximum working pressure. This ratio equals 4/1 as specified in the ISO 7751 standard. Also take care of hydraulic system pressure drop on page 292.

Ends (couplings)

To identify the right end connection, note that a hose coupling consists of two functional ends:

- **The hose/coupling interface** to connect the hose with the coupling.
The coupling must be designed and tested to assure optimal grip to hose cover, wire and tube and to perform to the applicable international standards.
- **The coupling termination** to connect the hose assembly to the equipment port or adaptor. Different termination types exist and offer different sealing solutions. This can be done via mating thread, cone, O-ring, flange end... As the market becomes more global, it is important to recognise and identify its differences and features. International thread ends can be metric (measured in millimetres), American or British Standard Pipe (measured in inches), while Japanese or Korean machine manufacturers often use JIS (Japanese Industrial Standard), measured in millimetres as well. The coupling seat (inverted, regular or flat), the seat angle (30°, 12°) and thread (imperial or metric, parallel or tapered) are determined by the termination type like DIN, SAE, JIC, BSP according to ISO 12151.

Selecting the correct coupling on page 295 provides further details.

Delivery (flow rate)

The amount of fluid that must pass through a hose determines the size of the hose needed. Velocity of hydraulic fluid should always fall within a specific range. ISO 4413 standard recommends the flow velocity not to be over 5m/s. When the flow rate is known, the hose bore can be determined easily with the help of the nomographic chart, see page 290.

HOSE SIZE SELECTION NOMOGRAM

How to use the nomographic chart

To determine the recommended hose assembly size where the flow rate is known, lay a straight edge across the three columns so that the edge registers with the flow rate figure in the left hand scale, and the recommended velocity range in the right hand scale. The point at which the straight edge intersects the centre scale indicates the recommended hose bore size.

Should this reading not coincide with a standard hose assembly bore size, the right hand edge of the straight edge may be adjusted up or down, within the recommended velocity range, until the straight edge registers with a standard bore size in the centre scale.

EXAMPLE

Where flow rate is 100 litres per minute and recommended flow velocity is 4.5 metres per second a 25 mm (1 inch) bore size hose assembly is indicated.

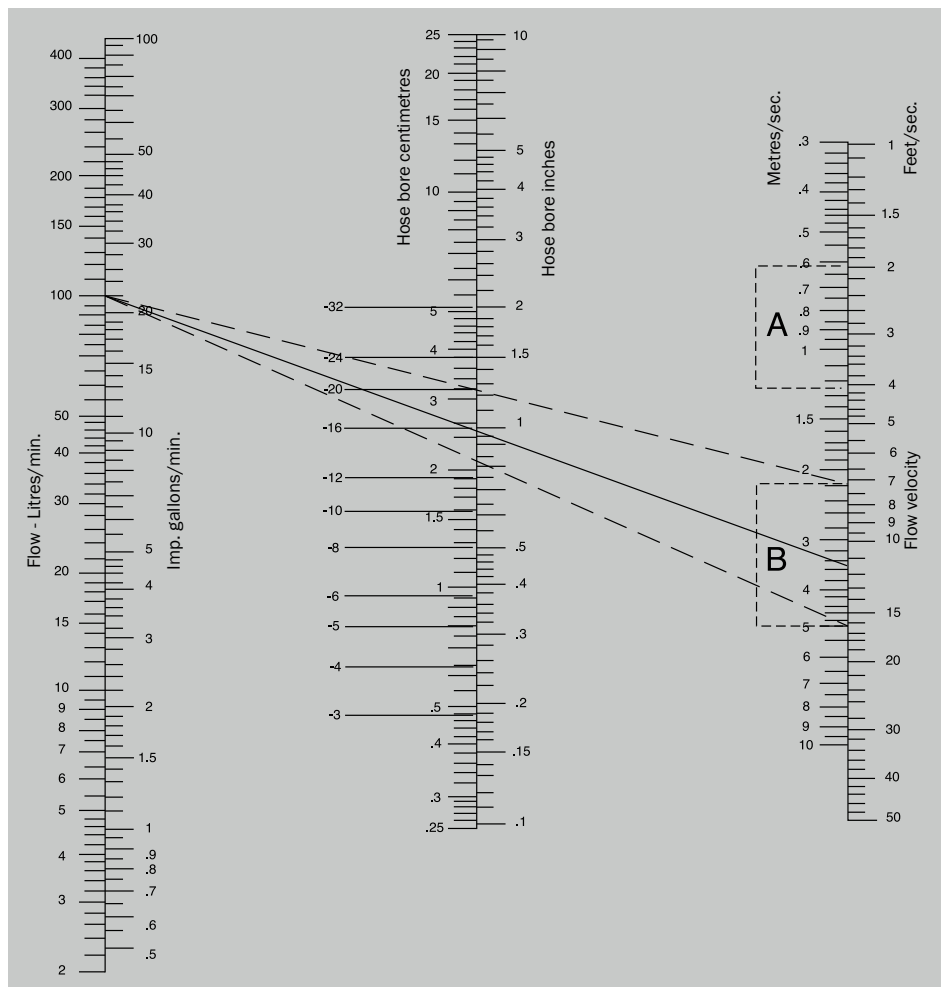

NOTE

Flow velocities in range A are recommended for suction and return lines.

Flow velocities in range B are recommended for delivery lines.

ISO 4413 standard recommends flow velocity not to be over 5 m/s.



MATERIAL TO BE CONVEYED

Some applications require specialised oils or chemicals to be conveyed through the system. Product selection must assure compatibility of the hose tube, cover, couplings and 'O' rings with the fluid used. Additional caution must be exercised when selecting a hose for gaseous applications where permeation can occur. Permeation of fluid through the hose wall may occur when a hose is used in combination with fluids such as (but not limited to) liquid and gas fuels, refrigerants, helium, fuel oil, natural gas, LPG and Freon.

Consider the possibility of hazardous effects of permeation through the hose, such as explosions, fires and toxicity. Refer to applicable standards for specific applications such as fuels and refrigerants. If fluids permeate through the hose tube, consider the use of perforated covers to prevent fluid build-up under the cover. Also ensure the compatibility of the system fluid not only with the hose tube, but also with the reinforcement, cover, fittings and other components since permeation may expose the entire hose assembly to the system fluid.

Biodegradable fluids

Traditionally, most common hydraulic fluids are petroleum-based oils. For applications in environmentally sensitive areas, the industry is now moving towards alternative fluids, either synthetic (primarily ester based) or vegetable based. Vegetable oils are gaining ground over synthetic ones because they cost less and biodegrade faster.

The challenge of biodegradable fluids? They easily permeate ordinary hose tubes, causing blisters and sweating on the cover of the hose, with premature hose failure as a consequence. Selecting the hose with the proper tube compound is key in assuring full compatibility to handle aggressive alternative hydraulic fluids.

Vegetable based oils usually have good compatibility with rubber hose products whereas synthetic ester oils are more aggressive and must be used with caution. General compatibility guidelines for rubber hoses are as follows:

	VEGETABLE BASED	SYNTHETIC ESTER BASED
Spiral wire and Xpiral hose	OK	generally OK
Wire braid hose	OK	generally OK
Textile braid hose	OK	generally OK

Recommended biodegradable fluids:

- Shell Naturelle HF-E46 - Synthetic ester
- IRM901 - Paraffinic mineral oil
- BinoI Hydrap - Rape seed oil
- Elf Oil 15W40 - Engine 0.1
- Hydrolub Bio 46 - Synthetic ester
- IGOL MATIC 259 - Mineral oil

Please contact Gates application engineering department for further fluid compatibility tests for your specific fluid.



Water temperature limits for hydraulic hoses

According to ISO 8330 “Rubber and plastic hoses and hose assemblies - Vocabulary”, the working temperature is the “maximum or minimum temperature at which a hose is designed to be serviceable”. This temperature range is indicated in the hose pages. However, note that the nature of the hydraulic fluid used can lower the maximum working temperature. The below chart shows the maximum working temperature for Gates hoses when used with water-based hydraulic fluids.

The main reasons for lowering maximum working temperatures of hydraulic systems using water-based hydraulic fluids are:

- Hot water can leach the plasticiser out of the rubber compound, whereby the hose becomes stiff and brittle.
- Heated water even under pressure can de-gas and cause gas bubbles. These gas bubbles contain about 20% oxygen which will lead to oxidation of the metal parts of the system.
- Mixed phases of hot water and steam can occur, which causes several issues like tube popcorning, permeation of steam through the walls of the hose and even steam hammer.

CAUTION!

MAXIMUM TEMPERATURE LIMITS FOR WATER, WATER/OIL EMULSIONS AND WATER/GLYCOL SOLUTIONS.

Hose	Pressure lines	Return lines
EFGxK, MXG, MXT, MxK, M2T, G2, G1, G2L, EFGxKL, M4KL, Pro Series	+93°C	+82°C
G2H, G1H, G2XH, G3H, GTH, M4KH, M3KH, GMV	+107°C	+82°C
TH8, TH7	+70°C	+70°C

The fluid manufacturer’s recommended maximum temperature for any given fluid must not be exceeded. If different from the above listed hose temperatures, the lower limit must be chosen.

HYDRAULIC SYSTEM PRESSURE DROP

Pressure

Factors that can influence the amount of pressure drop:

- **Friction**
This is the turbulence of fluid against the inside walls of the hose assembly and within itself generating heat and causing pressure drop.
- **Type of fluid**
Different fluids behave differently under pressure. Thicker fluids are moved with greater difficulty and will exhibit greater pressure drop because of greater friction loss.
- **Temperature of the fluid**
Warming fluids thins them, so they are moved more easily.
- **Length of hose assembly**
The longer the hose assembly, the more surface area there is for friction to decrease pressure.
- **Size (I.D.) of hose**
Affects the fluid velocity for a given flow rate. Higher velocities result in greater pressure drop. Therefore, a larger I.D. hose will produce less pressure drop.
- **Type of couplings and adaptors**
Any change in bore or change in direction (such as with 45° or 90° elbow) can increase the amount of pressure drop. So keep hose assembly routing as smooth as possible.
- **Flow rate**
Pressure drop increases with flow rate for the same size hose.

Why is knowing the amount of pressure drop so important?

Suppose you need 275 bar of output from a hose assembly for hydraulic equipment to run efficiently. There will be some pressure drop and you must allow for it in plumbing the system with hose, couplings and adaptors. This means that the input pressure to the hose assembly must be equal to the output, plus the amount of pressure drop. If the pressure drop in this example is 10 bar, then you will need 285 bar of input.

$$\text{Output pressure} = \text{input pressure} - \text{pressure drop}$$

$$275 \text{ bar} = 285 \text{ bar} - 10 \text{ bar}$$

How can you determine the amount of pressure drop?

The best way is to contact your Gates representative who is trained and equipped to quickly solve such problems for you. He will need the following information: type of application, fluid type and viscosity (at desired temperature), fluid temperature, fluid flow rate, hose size and length, number and type of fittings. The following graph will also help you to determine the amount of pressure drop.

Hose pressure drop

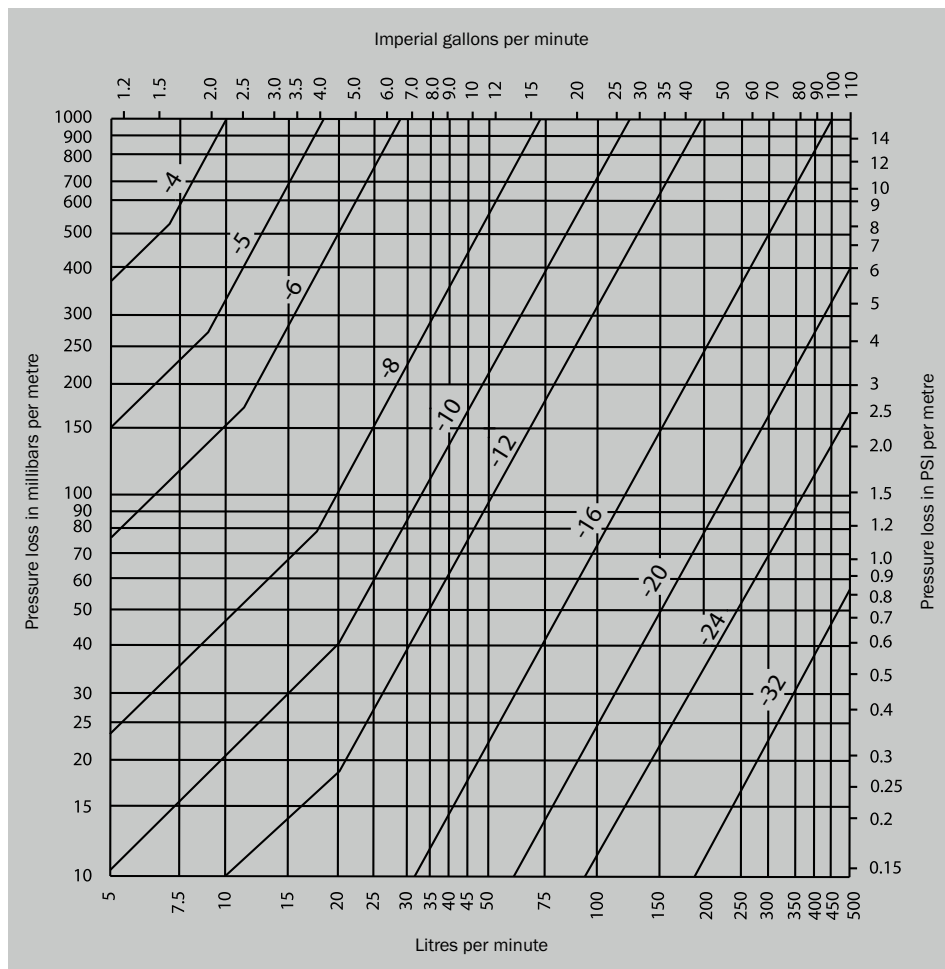

Based on: fluid viscosity 20 cSt
specific gravity 0.875



SELECTING THE CORRECT COUPLING



COUPLING SELECTION CRITERIA

Several factors, such as thread end compatibility, corrosion resistance, vibration, temperature, pressure, use of adaptors and fluid compatibility must be considered when selecting a coupling:

Thread end compatibility

Thread ends must be compatible in order to prevent leaking or assembly blowoff. Fittings seal three ways: thread interface, seat angles and/or 'O' rings. It is critical that both the male and female fittings are compatible to ensure an effective seal. Incorrect sealing will cause leaks, which can represent a safety and environmental hazard. For detailed explanation of thread identification see page 306.

Temperature

Metal surfaces can expand and contract under extreme temperature fluctuations. Choose couplings with 'O' rings for sealing. The 'O' ring will seal as the metal moves. It may be necessary to use 'O' ring materials that are suitable for high temperatures.

Fluid compatibility

Hydraulic hose is commonly selected by its compatibility with fluid, while couplings usually are not. However, 'O' rings (generally nitrile) can also be affected and need to be checked for fluid compatibility (see page 291).

Corrosion resistance

Gates hydraulic fittings are manufactured from carbon steel and are plated for excellent corrosion resistance. Other materials such as stainless steel are also used.

Pressure

Working pressure should be a consideration when selecting a fitting. Some fittings do not seal well at high pressures and can develop a leak. 'O' ring type fittings as well as solid port connectors work well at high pressures.

Vibration

Coupling selection may be influenced by motion and/or vibration at the end connection, which can potentially weaken or loosen a connection. Split flange couplings, or other couplings containing an 'O' ring for sealing, perform better under vibration. Avoid use of couplings that seal on the threads.

Use of adaptors

Some couplings connect directly to a port, while others need adaptors. This can influence coupling selection. Connecting directly to the port eliminates the need for an additional connection, but can make installation more difficult. Adaptors can make installation easier and eliminate the need for coupling orientation, but introduce an additional connection or possible leak point.

COUPLING IDENTIFICATION

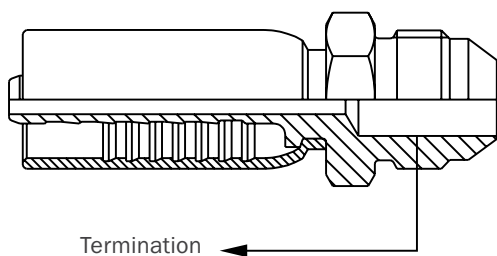

	MALE THREAD	FEMALE THREAD	NO THREAD
Metric	MDL / MDH	FDLORX / FDHORX	MSP
	MFG		FPFL
		FFGX	MPFL
			DBJ
BSP (British Standard Pipe)	MBSPT	FBSPORX	BSPBJ
	MBSPP	FBFFX	
	MBFF		
JIC (Joint Industrial Council)	MJ	FJX	
SAE (Society of Automotive Engineers)	MFFOR	FFORX	FL
	MFA	FSX	FLH
	MS		
	MB		
	MBX		
NPTF (American Standard Pipe Taper Fuel)	MP		
	MPX		
UNS (Unified National Special)	MIX		
Japanese metric		FKX	FLK
JIS (Japanese Industrial Standard)		FJISX	

TABLE OF CONTENTS

ABOUT GATES

HYDRAULIC HOSE

HYDRAULIC HOSE COUPLINGS

ENGINEERING AND TECHNICAL DATA

SELECTING THE CORRECT COUPLING





FEMALE COUPLINGS

BSP FBSPORX

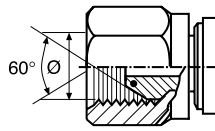
Female BSP 'O' ring swivel.
60° cone.





			
	Thread size	Threads/inch	mm
04FBSPORX	1/4" - 19	19	11.7
06FBSPORX	3/8" - 19	19	15.2
08FBSPORX	1/2" - 14	14	18.9
10FBSPORX	5/8" - 14	14	20.9
12FBSPORX	3/4" - 14	14	24.4
16FBSPORX	1" - 11	11	30.6
20FBSPORX	1.1/4" - 11	11	39.3
24FBSPORX	1.1/2" - 11	11	45.2
32FBSPORX	2" - 11	11	59.5

BSP FBFFX

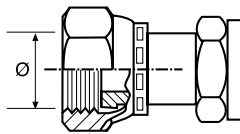
Female BSP flat face swivel.





			
	Thread size	Threads/inch	mm
06FBFFX	3/8" - 19	19	15.2
08FBFFX	1/2" - 14	14	18.9
10FBFFX	5/8" - 14	14	20.9
12FBFFX	3/4" - 14	14	24.4

JIC FJX

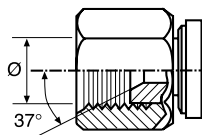
Female JIC swivel.
37° inverted cone.





			
	Thread size	Threads/inch	mm
04FJX	7/16" - 20	20	9.9
05FJX	1/2" - 20	20	11.5
06FJX	9/16" - 18	18	12.9
08FJX	3/4" - 16	16	17.5
10FJX	7/8" - 14	14	20.5
12FJX	1.1/16" - 12	12	25.0
14FJX	1.3/16" - 12	12	28.2
16FJX	1.5/16" - 12	12	31.3
20FJX	1.5/8" - 12	12	39.2
24FJX	1.7/8" - 12	12	45.5
32FJX	2.1/2" - 12	12	61.4

JIS FJISX

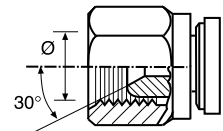
Female Japanese swivel.
30° inverted cone.
BSP thread.





			
	Thread size	Threads/inch	mm
04FJISX	1/4" - 19	19	11.7
06FJISX	3/8" - 19	19	15.2
08FJISX	1/2" - 14	14	18.9
12FJISX	3/4" - 14	14	24.4
16FJISX	1" - 11	11	30.6

JIS FKX

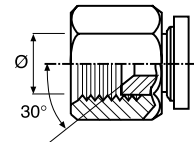
Female Japanese swivel.
30° inverted cone.
Metric thread.





		
	Thread size	mm
04FKX	M14 x1.5	12.5
06FKX	M18 x1.5	16.5
08FKX	M22 x1.5	20.5
10FKX	M24 x1.5	22.5
12FKX	M30 x1.5	28.5
16FKX	M33 x1.5	31.5
20FKX	M36 x1.5	34.5

SAE FFORX

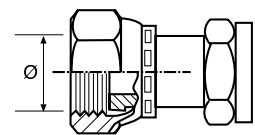
Female SAE flat face
'O' ring swivel.



			
	Thread size	Threads/inch	mm
04FFORX	9/16" - 18	18	12.9
06FFORX	11/16" - 16	16	15.9
08FFORX	13/16" - 16	16	19.1
10FFORX	1" - 14	14	23.6
12FFORX	1.3/16" - 12	12	28.0
16FFORX	1.7/16" - 12	12	34.4
20FFORX	1.11/16" - 12	12	40.7
24FFORX	2" - 12	12	48.7



SELECTING THE CORRECT COUPLING

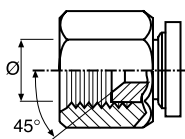

SAE FSX

Female SAE swivel.
45° inverted cone.





			
	Thread size	Threads/inch	mm
04FSX	7/16" - 20	20	9.9
05FSX	1/2" - 20	20	11.5
06FSX	5/8" - 18	18	15.7
08FSX	3/4" - 16	16	17.5
10FSX	7/8" - 14	14	20.5
12FSX	1.1/16" - 14	14	25.2

FG FFGX

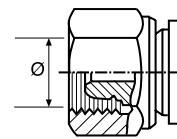
Female French Gaz swivel.
24° cone.





			
	Thread size	Threads mm	mm
13FFGX	20 x 1.5	18.5	13.25
17FFGX	24 x 1.5	22.5	16.75
21FFGX	30 x 1.5	28.5	21.25
27FFGX	36 x 1.5	34.5	26.75
34FFGX	45 x 1.5	43.5	33.50
42FFGX	52 x 1.5	50.5	42.25

FDLORX / FDHORX

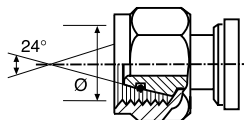
Female DIN 'O' ring swivel.
24° cone.
Light series / Heavy series.





				
	Thread size	Threads mm	Tube mm	Series
06FDLORX	12 x 1.5	10.5	6	L
06FDHORX	14 x 1.5	12.5	6	S
08FDLORX	14 x 1.5	12.5	8	L
08FDHORX	16 x 1.5	14.5	8	S
10FDLORX	16 x 1.5	14.5	10	L
10FDHORX	18 x 1.5	16.5	10	S
12FDLORX	18 x 1.5	16.5	12	L
12FDHORX	20 x 1.5	18.5	12	S
14FDLORX	20 x 1.5	18.5	14	L
14FDHORX	22 x 1.5	20.5	14	S
15FDLORX	22 x 1.5	20.5	15	L
16FDHORX	24 x 1.5	22.5	16	S
18FDLORX	26 x 1.5	24.5	18	L
20FDHORX	30 x 2.0	28.0	20	S
22FDLORX	30 x 2.0	28.0	22	L
25FDHORX	36 x 2.0	34.0	25	S
28FDLORX	36 x 2.0	34.0	28	L
30FDHORX	42 x 2.0	42.0	30	S
35FDLORX	45 x 2.0	43.0	35	L
38FDHORX	52 x 2.0	50.0	38	S

DIN FDLX / FDHX

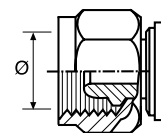
Female DIN swivel. 24°/60° cone.
Light series / Heavy series.



				
	Thread size	Threads mm	Tube mm	Series
06FDLX	12 x 1.5	10.5	6	L
08FDLX	14 x 1.5	12.5	8	L
08FDHX	16 x 1.5	14.5	8	S
10FDLX	16 x 1.5	14.5	10	L
10FDHX	18 x 1.5	16.5	10	S
12FDLX	18 x 1.5	16.5	12	L
12FDHX	20 x 1.5	18.5	12	S
14FDHX	22 x 1.5	20.5	14	S
15FDLX	22 x 1.5	20.5	15	L
16FDHX	24 x 1.5	22.5	16	S
18FDLX	26 x 1.5	24.5	18	L
20FDHX	30 x 2.0	28.0	20	S
22FDLX	30 x 2.0	28.0	22	L
28FDLX	36 x 2.0	34.0	28	L

SELECTING THE CORRECT COUPLING



NPTF FPX

Female NPSM pipe swivel.
30° cone.

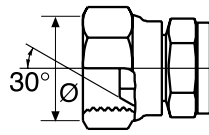

	Thread size	Threads/inch	mm
04FPX	1/4" - 18	18	9.1
06FPX	3/8" - 18	18	11.9
08FPX	1/2" - 14	14	15.5
12FPX	3/4" - 14	14	19.1
16FPX	1" - 11.5	11.5	30.7

NPTF FP

Female NPTF pipe.

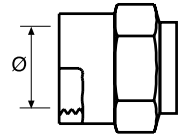

	Thread size	Threads/inch
02FP	1/8" - 27	28
04FP	1/4" - 18	18
06FP	3/8" - 18	18
08FP	1/2" - 14	14
12FP	3/4" - 14	14

MALE COUPLINGS

BSP MBSPT

Male BSP taper.

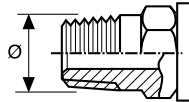

	Thread size	Threads/inch	mm
04MBSPT	1/4" - 19	19	13.6
06MBSPT	3/8" - 19	19	17.1
08MBSPT	1/2" - 14	14	21.5
10MBSPT	5/8" - 14	14	23.4
12MBSPT	3/4" - 14	14	27.0
16MBSPT	1" - 11	11	33.9

BSP MBFF

Male BSP flat face.

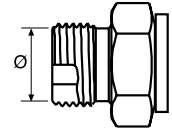

	Thread size	Threads/inch	mm
08MBFF	1/2" - 14	14	20.8

JIC 37° MJ

Male JIC parallel.
37° cone.

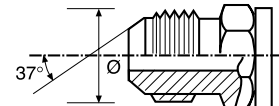

BSP MBSPP

Male BSP parallel.
60° inverted cone.

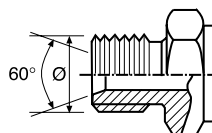

	Thread size	Threads/inch	mm
04MBSPP	1/4" - 19	19	13.0
06MBSPP	3/8" - 19	19	16.5
08MBSPP	1/2" - 14	14	20.8
10MBSPP	5/8" - 14	14	22.8
12MBSPP	3/4" - 14	14	26.3
16MBSPP	1" - 11	11	33.1
20MBSPP	1.1/4" - 11	11	41.8
24MBSPP	1.1/2" - 11	11	47.7

	Thread size	Threads/inch	mm
04MJ	7/16" - 20	20	11.0
05MJ	1/2" - 20	20	12.5
06MJ	9/16" - 18	18	14.1
08MJ	3/4" - 16	16	18.9
10MJ	7/8" - 14	14	22.1
12MJ	1.1/16" - 12	12	26.9
14MJ	1.3/16" - 12	12	30.0
16MJ	1.5/16" - 12	12	33.2
20MJ	1.5/8" - 12	12	41.2
24MJ	1.7/8" - 12	12	47.5
32MJ	2.1/2" - 12	12	63.3

SELECTING THE CORRECT COUPLING



TABLE OF CONTENTS

ABOUT GATES

HYDRAULIC HOSE



HYDRAULIC HOSE COUPLINGS

ENGINEERING AND TECHNICAL DATA

SAE MFFOR

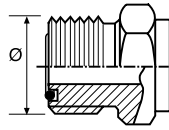
Male SAE flat face 'O' ring.





			
	Thread size	Threads/inch	mm
04MFFOR	9/16" - 18	18	14.1
06MFFOR	11/16" - 16	16	17.3
08MFFOR	13/16" - 16	16	22.0
10MFFOR	1" - 14	14	25.3
12MFFOR	1.3/16" - 12	12	30.0
16MFFOR	1.7/16" - 12	12	36.3
20MFFOR	1.11/16" - 12	12	42.6

SAE 24° MFA

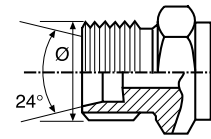
Male SAE parallel. 24° inverted cone.





			
	Thread size	Threads/inch	mm
04MFA	7/16" - 20	20	11.0
05MFA	1/2" - 20	20	12.5
06MFA	9/16" - 18	18	14.1
08MFA	3/4" - 16	16	18.9
10MFA	7/8" - 14	14	22.1
12MFA	1.1/16" - 12	12	26.9
16MFA	1.5/16" - 12	12	33.2

SAE 45° MS

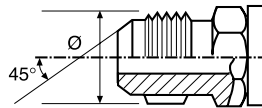
Male SAE parallel. 45° cone.





			
	Thread size	Threads/inch	mm
04MS	7/16" - 20	20	11.0
06MS	5/8" - 18	18	15.7
08MS	3/4" - 16	16	18.9
10MS	7/8" - 14	14	22.1
12MS	1.1/16" - 14	14	26.9

DIN 24° MDL / MDH

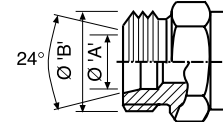
Male DIN parallel. 24° inverted cone. Light / Heavy series.





			
	Thread size	A mm	B mm
06MDL	12 x 1.5	6	12
08MDL	14 x 1.5	8	14
08MDH	16 x 1.5	8	16
10MDL	16 x 1.5	10	16
10MDH	18 x 1.5	10	18
12MDL	18 x 1.5	12	18
12MDH	20 x 1.5	12	20
14MDH	22 x 1.5	14	22
15MDL	22 x 1.5	15	22
16MDH	24 x 1.5	16	24
18MDL	26 x 1.5	18	26
20MDH	30 x 2.0	20	30
22MDL	30 x 2.0	22	30
25MDH	36 x 2.0	25	36
28MDL	36 x 2.0	28	36
30MDH	42 x 2.0	30	42
35MDL	45 x 2.0	35	45
38MDH	52 x 2.0	38	52

SAE 45° MIX

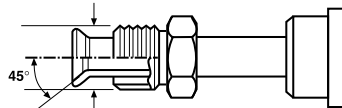
Male SAE parallel. 45° inverted cone.



			
	Thread size	Threads/inch	mm
04MIX	7/16" - 24	24	11.0
05MIX	1/2" - 20	20	12.5
06MIX	5/8" - 18	18	15.7
07MIX	11/16" - 18	18	17.3
08MIX	3/4" - 18	18	18.9

SELECTING THE CORRECT COUPLING



NPTF MP

Male NPTF pipe.

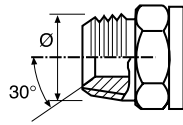

	Thread size	Threads/inch	mm
02MP	1/8" - 27	27	10.3
04MP	1/4" - 18	18	13.9
06MP	3/8" - 18	18	17.3
08MP	1/2" - 14	14	21.6
12MP	3/4" - 14	14	26.9
16MP	1" - 11.5	11.5	33.7
20MP	1.1/4" - 11.5	11.5	42.5
24MP	1.1/2" - 11.5	11.5	48.6
32MP	2" - 11.5	11.5	60.7

NPTF MPX

Male NPTF pipe swivel.

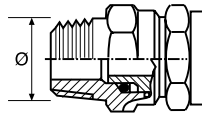

	Thread size	Threads/inch	mm
04MPX	1/4" - 18	18	13.9
06MPX	3/8" - 18	18	17.3
08MPX	1/2" - 14	14	21.6
12MPX	3/4" - 14	14	26.9
16MPX	1" - 11.5	11.5	33.7

UNF MB

Male SAE 'O' ring boss.

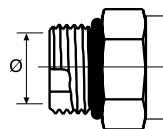

	Thread size	Threads/inch	mm
04MB	7/16" - 20	20	11.0
05MB	1/2" - 20	20	12.5
06MB	9/16" - 18	18	14.1
08MB	3/4" - 16	16	18.9
10MB	7/8" - 14	14	22.1
12MB	1.1/16" - 12	12	26.9
14MB	1.3/16" - 12	12	30.0
16MB	1.5/16" - 12	12	33.2
20MB	1.5/8" - 12	12	41.2

UNF MBX

Male SAE 'O' ring boss swivel.

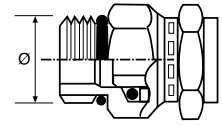

	Thread size	Threads/inch	mm
06MBX	9/16" - 18	18	14.1
08MBX	3/4" - 16	16	18.9
10MBX	7/8" - 14	14	22.1
12MBX	1.1/16" - 12	12	26.9

FG MFG

Male French Gaz parallel.
24° inverted cone.

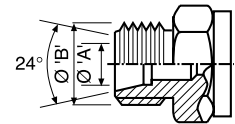

	Thread size		A mm	B mm
13MFG	20 x 1.5		13.2	20.0
17MFG	24 x 1.5		16.9	24.0
21MFG	30 x 1.5		21.4	30.0
27MFG	36 x 1.5		26.9	36.0
34MFG	45 x 1.5		33.7	45.0
42MFG	52 x 1.5		42.4	52.0

KOBELCO MKB

Male Kobelco type.

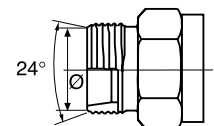

	Thread size	Threads/inch	mm
22MKB	30 x 1.5	22	30
28MKB	36 x 1.5	28	36
35MKB	45 x 1.5	35	45

BANJO COUPLINGS

BSP BSPBJ

BSP banjo.

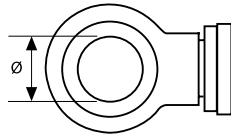

	∅	Bolt thread size
04BSPBJ	13.2	1/4" BSP
06BSPBJ	16.8	3/8" BSP
08BSPBJ	21.0	1/2" BSP
10BSPBJ	23.0	5/8" BSP
12BSPBJ	26.5	3/4" BSP
16BSPBJ	33.5	1" BSP

DIN DBJ

Metric banjo.

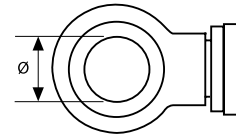

	∅	Bolt thread size
10DBJ	10.1	M10
12DBJ	12.1	M12
14DBJ	14.1	M14
16DBJ	16.1	M16
18DBJ	18.1	M18
22DBJ	22.1	M22
26DBJ	26.1	M26
30DBJ	30.1	M30

STANDPIPE COUPLINGS

METRIC MSP

DIN metric standpipe.

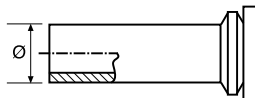

	∅	Series
06MSP	6	L
08MSP	8	L
10MSP	10	L
12MSP	12	L
15MSP	15	L
18MSP	18	L
22MSP	22	L

SELECTING THE CORRECT COUPLING



FLANGE COUPLINGS

SAE FL

SAE 'O' ring flange.
Code 61.

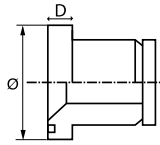

	Nominal size	Ø mm	D mm
08FL	1/2"	30.2	6.8
12FL	3/4"	38.1	6.8
16FL	1"	44.5	8.0
20FL	1.1/4"	50.8	8.0
24FL	1.1/2"	60.3	8.0
32FL	2"	71.4	9.6

SAE FLH

SAE 'O' ring flange high-pressure.
Code 62.

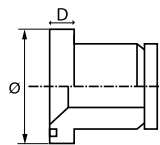

	Nominal size	Ø mm	D mm
08FLH	1/2"	31.8	7.8
12FLH	3/4"	41.3	8.8
16FLH	1"	47.6	9.5
20FLH	1.1/4"	54.0	10.3
24FLH	1.1/2"	63.5	12.6
32FLH	2"	79.4	12.6

FLK

Komatsu type 'O' ring flange.

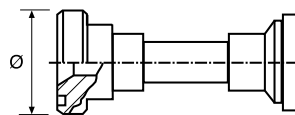

	Nominal size	Ø mm
10FLK	5/8"	34.2

FLC

Caterpillar type 'O' ring flange.

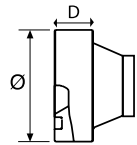

	Nominal size	Ø mm	D mm
12FLC	3/4"	41.4	14.2
16FLC	1"	47.6	14.2
20FLC	1.1/4"	54.0	14.2
24FLC	1.1/2"	63.5	14.2
32FLC	2"	79.5	14.2

FG FPFL

Female French Gaz flange high-pressure.
24° Poclairn inverted cone.

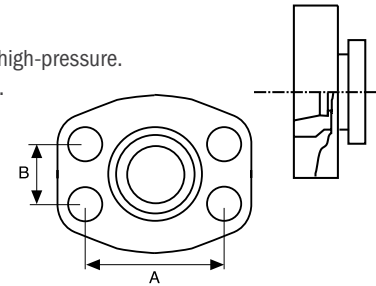

	A mm	B mm
17FPFL	40.0	18.2
21FPFL	40.0	18.2
27FPFL	50.8	23.8
34FPFL	57.3	27.3

FG MPFL

Male French Gaz flange high-pressure.
24° Poclairn cone.

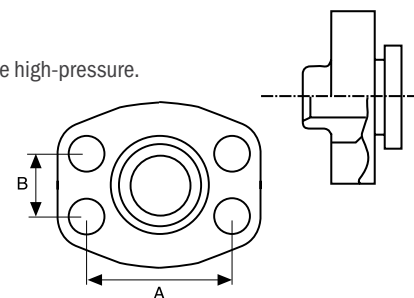

	A mm	B mm
17MPFL	40.0	18.2
21MPFL	40.0	18.2
27MPFL	50.8	23.8
34MPFL	57.3	27.3

SELECTING THE CORRECT COUPLING



'O' RINGS

-size	FBSPORX 70 / ** 80 SHORE mm	MFFOR 90 SHORE mm	FL 70 SHORE mm	FLH 90 SHORE mm	PWSP 90 SHORE mm	FPWX 90 SHORE mm
-4	5.5 x 1	7.65 x 1.78			7.1 x 1.6	11.0 x 1.5
-5		8.50 x 1.78			7.1 x 1.6	11.0 x 1.5
-6	7.1 x 1.6	9.25 x 1.78			7.1 x 1.6	11.0 x 1.5
-8	11.1 x 1.6	12.42 x 1.78	18.64 x 3.53	18.64 x 3.53		
-10	12.1 x 1.6	15.6 x 1.78				
-12	15.1 x 1.6	18.77 x 1.78	24.99 x 3.53	24.99 x 3.53		
-16	20.1 x 1.6	23.52 x 1.78	32.92 x 3.53	32.92 x 3.53		
-20	27.1 x 1.6	29.87 x 1.78	37.69 x 3.53	37.69 x 3.53		
-24	32.1 x 1.6 **		47.22 x 3.53	47.22 x 3.53		
-32	44.17 x 1.78		56.75 x 3.53	56.75 x 3.53		

Tube mm	FDHORX 90 SHORE mm	FDLORX 90 SHORE mm
6	4.0 x 1.5	4.0 x 1.5
8	6.0 x 1.5	6.0 x 1.5
10	7.5 x 1.5	7.5 x 1.5
12	9.0 x 1.5	9.0 x 1.5
14	10.0 x 2.0 *	
15		12.0 x 2.0
16	12.0 x 2.0	
18		15.0 x 2.0
20	16.3 x 2.4	
22		20.0 x 2.0
25	20.3 x 2.4	
28		26.0 x 2.0
30	25.3 x 2.4	
35		32.0 x 2.5
38	33.3 x 2.4	
42		38.0 x 2.5

'O' rings meet dimensional requirements of ISO 8434-1 & 8434-4
 * 'O' ring dimensions for 14mm tube meet DIN 3865

TABLE OF CONTENTS

ABOUT GATES

HYDRAULIC HOSE

HYDRAULIC HOSE COUPLINGS

ENGINEERING AND TECHNICAL DATA

EASY IDENTIFICATION OF METRIC COUPLINGS

New applications for metric couplings

For all new metric applications always use the FDLORX or FDHORX Soft Seal couplings. The Soft Seal 'O' ring in the coupling cone provides additional sealing capability at the termination, at the initial startup as well as during the entire service life of the machine.

Vibrations cause the nuts to de-torque, therefore regular maintenance is required to prevent possible leak paths. Gates Soft Seal 'O' rings are not sensitive to vibration, therefore providing longer periods of cone-to-port sealing.

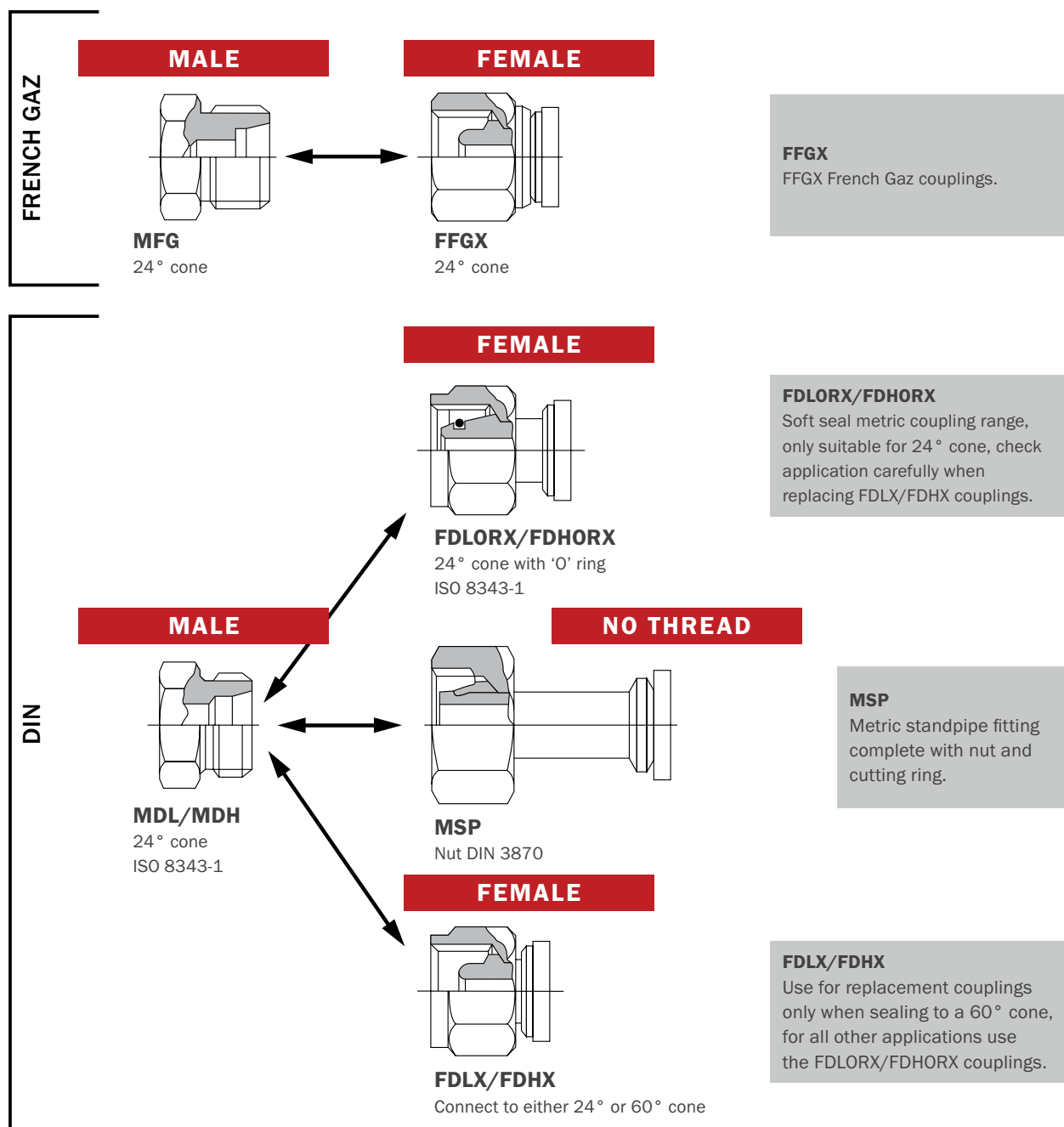

SELECTING THE CORRECT COUPLING



THREAD SIZE IDENTIFICATION GUIDE

9.1							
9.9							
10.3				1/8"-27 NPTF	2MP		
10.5							
11.0			7/16"-20 UNF 7/16"-20 UNF	4MJ 4MS	7/16"-24 UNS 7/16"-20 UNF	4MIX 4MFA	7/16"-20 UNF 4MB
11.5							
11.7							
11.9							
12.0					M12 x 1.5	6MDL	
12.5			1/2"-20 UNF	5MJ	1/2"-20 UNF 1/2"-20 UNF	5MIX 5MFA	1/2"-20 UNF 5MB
12.9							
13.0					1/4"-19 BSP	4MBSPP	
13.6	1/4"-19 BSP	4MBSPT					
13.9					1/4"-18 NPTF	4MP	
14.0					M14 x 1.5	8MDL	
14.1			9/16"-18 UNF	6MJ	9/16"-18 UNF	6MFA	9/16"-18 UNF 9/16"-18 UNF 9/16"-18 UNF 6MB 4MFFOR 6MBX
14.5							
15.2							
15.5							
15.7			5/8"-18 UNF	6MS	5/8"-18 UNF	6MIX	
15.9							
16.0					M16 x 1.5 M16 x 1.5 3/8"-19 BSP	8MDH 10MDL 6MBSPP	
16.5							
17.1	3/8"-19 BSP	6MBSPT					
17.3					3/8"-18 NPTF 11/16"-18 UNS	6MP 7MIX	11/16"-16 UN 6MFFOR
17.5							
18.0					M18 x 1.5 M18 x 1.5	10MDH 12MDL	
18.5							
18.9			3/4"-16 UNF 3/4"-16 UNF	8MJ 8MS	3/4"-18 UNS 3/4"-16 UNF	8MIX 8MFA	3/4"-16 UNF 3/4"-16 UNF 8MB 8MBX
19.1							
20.0					M20 x 1.5 M20 x 1.5	12MDH 13MFG	
20.5							
20.8					1/2"-14 BSP	8MBSPP	1/2"-14 BSP 8MBFF
20.9							
21.5	1/2"-14 BSP	8MBSPT					
21.6					1/2"-14 NPTF	8MP	
22.0					M22 x 1.5 M22 x 1.5	14MDH 15MDL	13/16"-16 UN 8MFFOR
22.1			7/8"-14 UNF 7/8"-14 UNF	10MJ 10MS	7/8"-14 UNF	10MFA	7/8"-14 UNF 7/8"-14 UNF 10MB 10MBX
22.5							
22.8					5/8"-14 BSP	10MBSPP	
23.4	5/8"-14 BSP	10MBSPT					
23.6							
24.0					M24 x 1.5 M24 x 1.5	16MDH 17MFG	
24.4							
24.5							
25.0							
25.2							
25.3							1"-14 UNS 10MFFOR
25.4							

TABLE OF CONTENTS

ABOUT GATES

HYDRAULIC HOSE

HYDRAULIC HOSE COUPLINGS

ENGINEERING AND TECHNICAL DATA

SELECTING THE CORRECT COUPLING

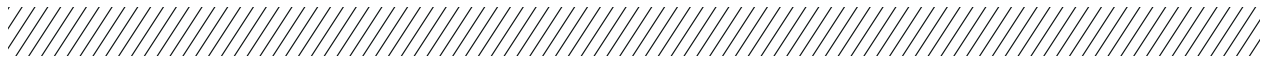

1/4"-18 NPSM	4FPX						9.1
			7/16"-20 UNF 7/16"-20 UNF	4FIX 4FSX			9.9
							10.3
M12 x 1.5 M12 x 1.5	6FDLORX 6FDLX						10.5
							11.0
			1/2"-20 UNF 1/2"-20 UNF	5FIX 5FSX			11.5
1/4"-19 BSP	4FBSPORX		1/4"-19 BSP	4FIJSX			11.7
3/8"-18 NPSM	6FPX						11.9
							12.0
M14 x 1.5 M14 x 1.5 M14 x 1.5	8FDLX 6FDHORX 8FDLORX	M14 x 1.5		4FKX			12.5
			9/16"-18 UNF	6FIX	9/16"-18 UNF	4FFORX	12.9
							13.0
							13.6
							13.9
							14.0
							14.1
M16 x 1.5 M16 x 1.5 M16 x 1.5 M16 x 1.5	10FDLORX 8FDHORX 8FDHX 10FDLX						14.5
3/8"-19 BSP	6FBSPORX	3/8"-19 BSP		6FIJSX	3/8"-19 BSP	6FBFFX	15.2
1/2"-14 NPSM	8FPX						15.5
			5/8"-18 UNF	6FSX			15.7
					11/16"-16 UN	6FFORX	15.9
							16.0
M18 x 1.5 M18 x 1.5 M18 x 1.5 M18 x 1.5	10FDHORX 12FDLORX 10FDHX 12FDLX	M18 x 1.5		6FKX			16.5
							17.1
							17.3
			3/4"-16 UNF 3/4"-16 UNF	8FSX 8FIX			17.5
							18.0
M20 x 1.5 M20 x 1.5 M20 x 1.5 M20 x 1.5	12FDHORX 14FDLORX 12FDHX 13FFGX						18.5
1/2"-14 BSP	8FBSPORX	1/2"-14 BSP		8FIJSX	1/2"-14 BSP	8FBFFX	18.9
3/4"-14 NPSM	12FPX				13/16"-16 UN	8FFORX	19.1
							20.0
M22 x 1.5 M22 x 1.5 M22 x 1.5 M22 x 1.5	14FDHORX 15FDLORX 14FDHX 15FDLX	7/8"-14 UNF M22 x 1.5		10FIX 8FKX			20.5
		7/8"-14 UNF		10FSX			20.8
							20.9
5/8"-14 BSP	10FBSPORX				5/8"-14 BSP	10FBFFX	21.5
							21.6
							22.0
							22.1
M24 x 1.5 M24 x 1.5 M24 x 1.5	17FFGX 16FDHORX 16FDHX	M24 x 1.5		10FKX			22.5
							22.8
					1"-14 UNS	10FFORX	23.4
							23.6
							24.0
3/4"-14 BSP	12FBSPORX	3/4"-14 BSP		12FIJSX	3/4"-14 BSP	12FBFFX	24.4
M26 x 1.5 M26 x 1.5	18FDLORX 18FDLX						24.5
			1.1/16"-12 UN	12FIX			25.0
			1.1/16"-14 UNS	12FSX			25.2
							25.3
M27 x 1.5	20RU27A						25.4

TABLE OF CONTENTS

ABOUT GATES

HYDRAULIC HOSE

HYDRAULIC HOSE COUPLINGS

ENGINEERING AND TECHNICAL DATA

SELECTING THE CORRECT COUPLING



TABLE OF CONTENTS

ABOUT GATES

HYDRAULIC HOSE

HYDRAULIC HOSE COUPLINGS

ENGINEERING AND TECHNICAL DATA

26.0					M26 x 1.5	18MDL		
26.3					3/4"-14 BSP	12MBSPP		
26.9			1.1/16"-12 UN 1.1/16"-14 UNS	12MJ 12 MS	1.1/16"-12 UN 3/4"-14 NPTF	12MFA 12MP	1.1/16"-12 UN 1.1/16"-12 UN	12MB 12MBX
27.0	3/4"-14 BSP	12MBSPT						
28.0								
28.2								
28.5								
30.0			1.3/16"-12 UN	14MJ	M30 x 1.5 M30 x 2.0 M30 x 2.0	21MFG 20MDH 22MDL	1.3/16"-12 UN 1.3/16"-12 UN	12MFFOR 14MB
30.2								
30.6								
30.7								
31.3								
31.5								
31.8								
33.1					1"-11 BSP	16MBSPP		
33.2			1.5/16"-12 UN	16MJ	1.5/16"-12 UN	16MFA	1.5/16"-12 UN	16MB
33.7					1"-11.5 NPTF	16MP		
33.9	1"-11 BSP	16MBSPT						
34.0								
34.2								
34.4								
34.5								
36.0					M36 x 1.5 M36 x 2.0 M36 x 2.0	27MFG 25MDH 28MDL		
36.3							1.7/16"-12 UN	16MFFOR
38.1								
39.2								
39.3								
40.5								
40.7								
41.2			1.5/8"-12 UN	20MJ			1.5/8"-12 UN	20MB
41.3								
41.4								
41.8					1.1/4"-11 BSP	20MBSPP		
42.0					M42 x 2.0	30MDH		
42.5					1.1/4"-11.5 NPTF	20MP		
42.6							1.11/16"-12 UN	20MFFOR
43.0								
43.5								
44.5								
45.0					M45 x 1.5 M45 x 2.0	34MFG 35MDL		
45.2								
45.5								
47.5			1.7/8"-12 UN	24MJ				
47.6								
47.7					1.1/2"-11 BSP	24MBSPP/24MU		
48.6					1.1/2"-11.5 NPTF	24MP/24MB		
48.7								
50.0								
50.8								
52.0					M52 x 1.5 M52 x 2.0 M52 x 2.0	42MFG 38MDH 42MZ52B		
54.0								
59.5					2"-11 BSP	32MU		
60.3								
60.5	2"-11 BSP	32MT						
60.7					2"-11.5 NPTF	32MP/32MB		
61.4								
63.3			2.1/2"-12 UN	32MJ				
63.5								
71.4								
79.4								
79.5								

SELECTING THE CORRECT COUPLING

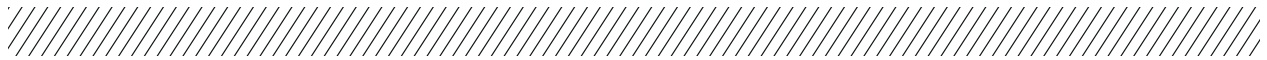

								26.0
								26.3
								26.9
								27.0
	M30 x 2.0 M30 x 2.0 M30 x 2.0 M30 x 2.0	20FDHORX 22FDLORX 20FDHX 22FDLX			13/16"-16 UN	12FFORX		28.0
			1.3/16"-12 UN	14FX				28.2
	M30 x 1.5	21FFGX	M30 x 1.5	12FKX				28.5
								30.0
							1/2" - CODE 61	30.2
	1"-11 BSP	16FBSPORX	1"-11 BSP	16FJISX	1"-11 BSP	16FBFFX	8FL	30.6
	1"-11.5 NPSM	16FPX						30.7
			1.5/16"-12 UN	16FX				31.3
			M33 x 1.5	16FKX				31.5
							1/2" - CODE 62	31.8
								33.1
								33.2
								33.7
								33.9
	M36 x 2.0 M36 x 2.0 M36 x 2.0	25FDHORX 28FDLORX 28FDLX						34.0
							5/8" - KOMATSU	34.2
					1.7/16"-12 UN	16FFORX	10FLK	34.4
	M36 x 1.5	27FFGX	M36 x 1.5	20FKX				34.5
								36.0
								36.3
							3/4" - CODE 61	38.1
			1.5/8"-12 UN	20FX			12FL	39.2
	1"1/4-11 BSP	20FBSPORX						39.3
								40.5
					1.11/16"-12 UN	20FFORX		40.7
								41.2
							3/4" - CODE 62	41.3
							3/4" - CAT	41.4
								41.8
	M42 x 2.0	30FDHORX						42.0
								42.5
								42.6
	M45 x 2.0	35FDLORX						43.0
	M45 x 1.5	34FFGX						43.5
							1" - CODE 61	44.5
								45.0
	1.1/2" -11 BSP	24FBSPORX						45.2
			1.7/8"-12 UN	24FX/24NU				45.5
								47.5
							1" - CODE 62	47.6
							1" - CAT	16FLH 16FLC
								47.7
								48.6
					2"-12 UN	24FFORX/24FF		48.7
	M52 x 2.0 M52 x 1.5 M52 x 1.5	38FDHORX 42RQ52A 42FFGX						50.0
							1.1/4" - CODE 61	20FL
								50.8
								52.0
							1.1/4" - CAT	20FLC
							1.1/4" - CAT	20FLH
	2"-11 BSP	32NU						54.0
							1.1/2" - CODE 61	24FL/24PA
								60.3
								60.5
								60.7
			2.1/2"-12 UN	32FX/32NU				61.4
								63.3
							1.1/2" - CAT	24FLC
							1.1/2" - CODE 62	24FLH
							2" - CODE 61	32FL/32PA
							2" - CODE 62	32FLH
							2" - CAT	32FLC
								79.4
								79.5

TABLE OF CONTENTS

ABOUT GATES

HYDRAULIC HOSE

HYDRAULIC HOSE COUPLINGS

ENGINEERING AND TECHNICAL DATA

SELECTING THE CORRECT COUPLING



COUPLING THREAD IDENTIFICATION

Following the steps below will enable you to identify an unknown coupling thread in a short period of time.

Step 1

Measure diameter of thread, outside of male threads and inside of female threads.

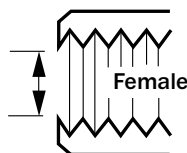
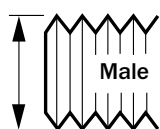
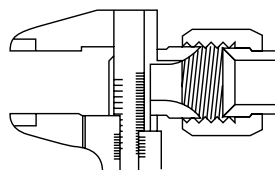
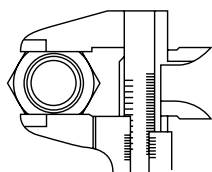

Step 2

Refer to the "Thread size identification guide" (see page 306) for details of coupling type and size.

Ø	1/4"	3/8"	1/2"	3/4"	1"	
9.1						
9.9						
10.3						
10.5						
11.0		7/16"-20 UNF 7/16"-20 UNF	4MJ 4MS	7/16"-20 UNF 7/16"-20 UNF	4MJ 4MS	
11.5						
11.7						
11.9						
12.0				M12 x 1.5	6MCL	
12.5		1/2"-20 UNF	5MJ	1/2"-20 UNF 1/2"-20 UNF	5MJ 5MA	
12.9						
13.0				1/4"-19 BSP	4MBSPT	
13.6	1/4"-19 BSP	4MBSPT				
13.9				1/4"-18 NPT	4MP	
14.0						
14.1				M14 x 1.5	6MCL	
14.1		9/16"-18 UNF	6MJ	9/16"-18 UNF	6MJ 6MFP 6MFL	
14.5						
15.2						
15.5						
15.7		5/8"-18 UNF	6MS	5/8"-18 UNF	6MS	
15.9						
16.0				M16 x 1.5 M16 x 1.5	6MCL 6MCL	
16.5				3/8"-19 BSP	6MBSPT	
17.1	3/8"-19 BSP	6MBSPT				
17.3				3/8"-18 NPT	6MP	
					1 1/16"-16 UN	6MFP

e.g. If outside diameter is 11.0 mm male would be 4MJ.

Ø	1/4"	3/8"	1/2"	3/4"	1"
9.1					
9.9					
10.3					
10.5					
11.0					
11.5					
11.7					
11.9					
12.0					
12.5					
12.9					
13.0					
13.6					
13.9					
14.0					
14.1					
14.5					
15.2					
15.5					
15.7					
15.9					
16.0					
16.5					
17.1					
17.3					

e.g. If inside diameter is 9.9 mm female would be 4FJX.

N.B. On MP/MB and MBSBPT/MT taper threads the maximum Ø is given.

Step 3

Check the coupling thread. With a thread gauge you can check the number of threads per inch (for imperial couplings) or the pitch of the threads (for metric couplings).

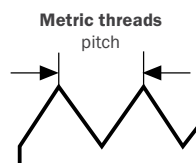
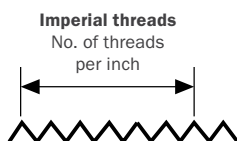
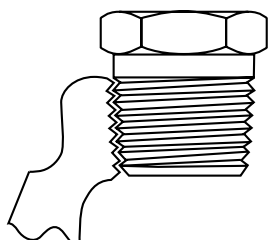

N.B. Coupling thread identification kits containing reference charts, vernier, seat gauges and thread gauges are available. Please ask for details.

TABLE OF CONTENTS

ABOUT GATES

HYDRAULIC HOSE

HYDRAULIC HOSE COUPLINGS

ENGINEERING AND TECHNICAL DATA



HOSE ASSEMBLY SELECTION AND INSTALLATION





CALCULATING THE HOSE ASSEMBLY LENGTH

Hose assemblies are made according to overall length i.e. cone face to cone face, or where elbow couplings are used, to the centre line of the cone face.

When determining the length of hose assemblies, provide sufficient length to prevent bending strain from localising at the back of the coupling. In the figure below dimension “B” allows for a strain section of hose beyond the coupling to prevent concentration of bending strain. “T” designates the amount of travel. “A” indicates the smallest diameter to which the hose should be bent (2x minimum bend radius).

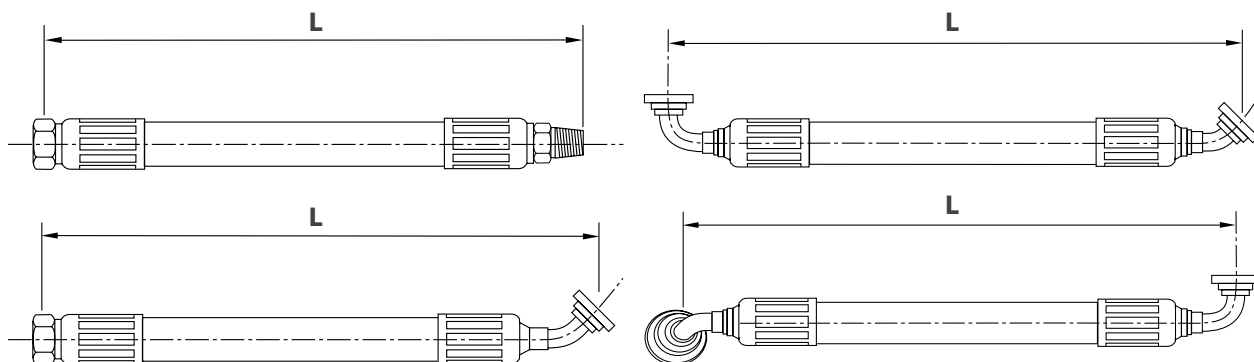

T (Actuation travel)

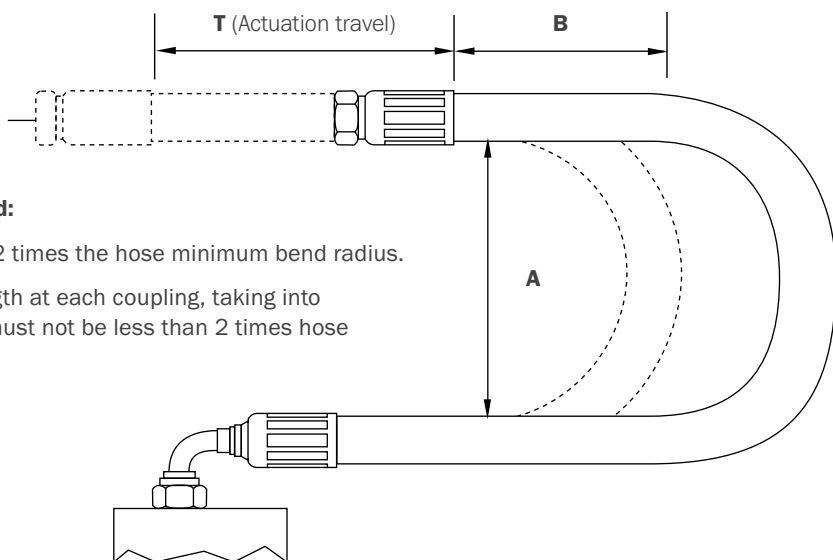

2 critical dimensions must be observed:

1. Dimension 'A' must not be less than 2 times the hose minimum bend radius.
2. Dimension 'B', the minimum free length at each coupling, taking into account 'T' the full actuation travel, must not be less than 2 times hose outside diameter.

CAUTION

When cutting hose, always wear safety glasses and avoid loose fitting clothing. Ear protection is also strongly recommended. Ensure adequate ventilation.

Fitting orientation

Fitting orientation is necessary when a hose assembly requires two angled couplings that are not in line when viewed from one end of a hose. Fittings must be orientated to each other to ensure proper installation with minimal stress on the hose from twisting.

Fitting orientation is measured from the centerline of the first coupling held in a vertical position and looking at the assembly from the second end by measuring in a clockwise direction.

Orientation angle tolerance should be ± 3 degrees for assemblies equal or less than 600 mm and ± 5 degrees for assembly lengths over 600 mm.

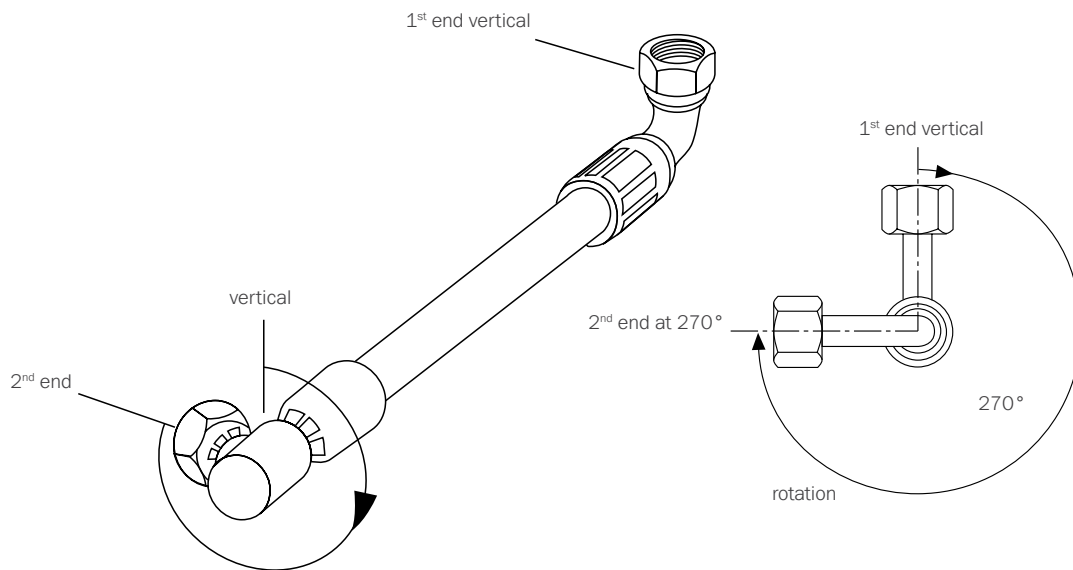

HOSE ASSEMBLY ROUTING TIPS

Proper hose installation is essential for satisfactory performance. As we have seen, if hose length is excessive, the appearance of the installation will be unsatisfactory and unnecessary cost of equipment will be involved. If hose assemblies are too short to permit adequate flexing and changes in length due to expansion or contraction, hose service life will be reduced.

The following diagrams show proper hose installations which provide maximum performance and cost savings. Consider these examples in determining the length of a specific assembly.

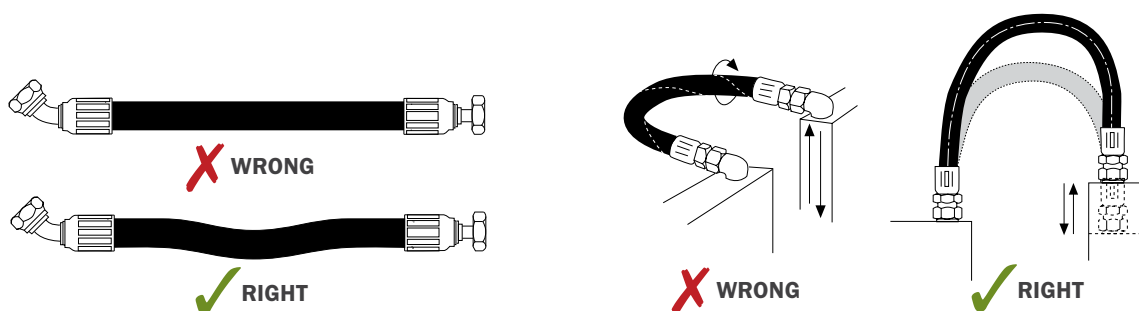

When hose installation is straight, allow enough slack in hose line to provide for length changes which will occur when pressure is applied.

Prevent twisting and distortion by bending hose in same plane as the motion of the boss to which hose is connected.

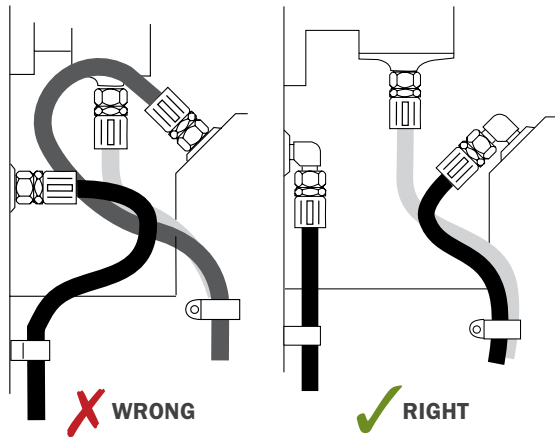

Route hose directly by using 45° and/or 90° adaptors and fittings. Avoid excessive hose length to improve appearance.

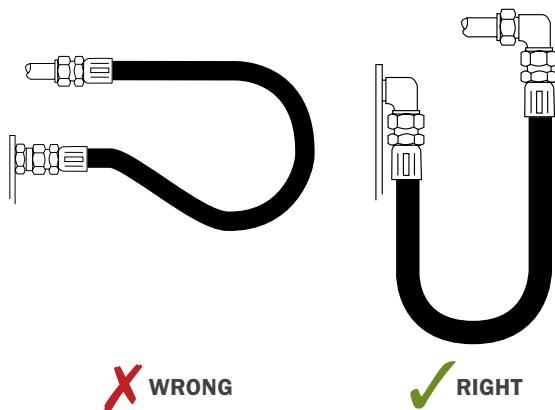

When radius is below the required minimum, use an angle adaptor to avoid sharp bends.

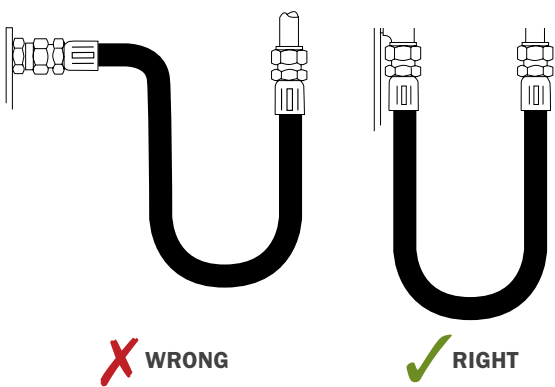

Use proper angle adaptors to avoid sharp twist or bend in hose.

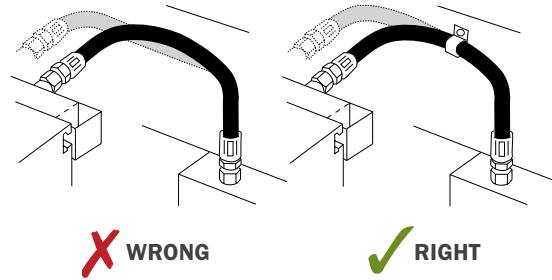

Avoid twisting of hose lines bent in two planes by clamping hose at change of plane.

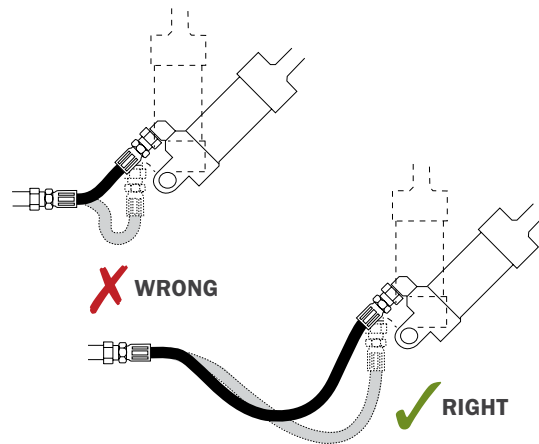

Adequate hose length is necessary to distribute movement on flexing applications and to avoid abrasion.

NO PRESSURE

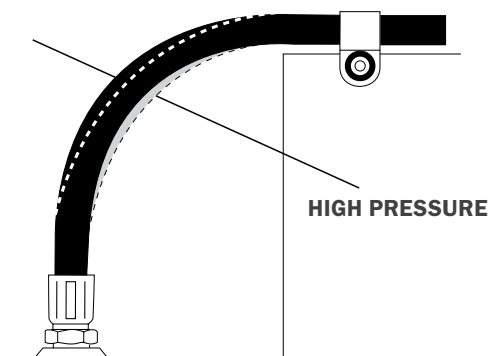

To allow for length changes when hose is pressurised, do not clamp at bends so that curves will absorb changes. Do not clamp high and low pressure lines together.

HOSE ASSEMBLY SELECTION AND INSTALLATION

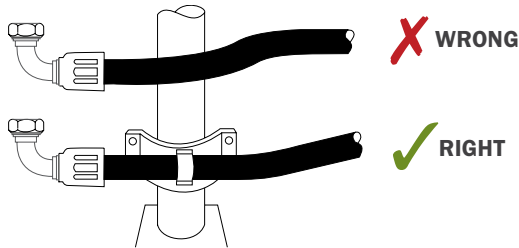

High ambient temperatures shorten hose life. Make sure hose is kept away from hot parts. If this is not possible, insulate the hose.

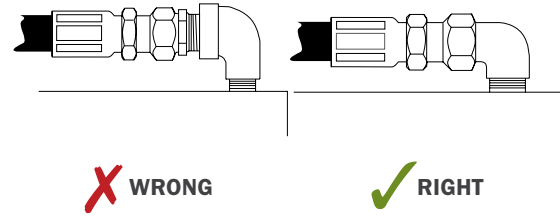

Reduce number of pipe thread joints by using proper hydraulic adaptors instead of pipe fittings.

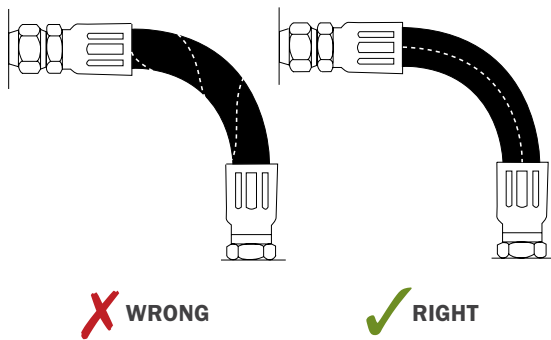

When installing a hose, make sure it is not twisted. Pressure applied to a twisted hose can result in hose failure or loosening of connections.

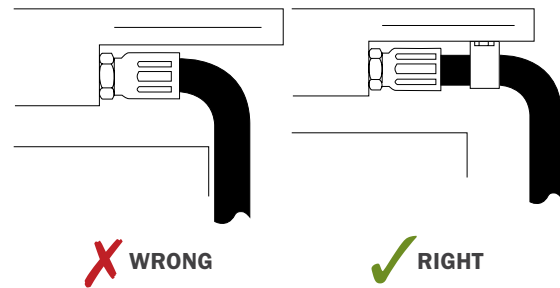

Run hose in the installation so that it avoids rubbing and abrasion. Often, clamps are required to support long hose runs or to keep hose away from moving parts. Use clamps of the correct size. Too large a clamp allows hose to move inside the clamp and causes abrasion.

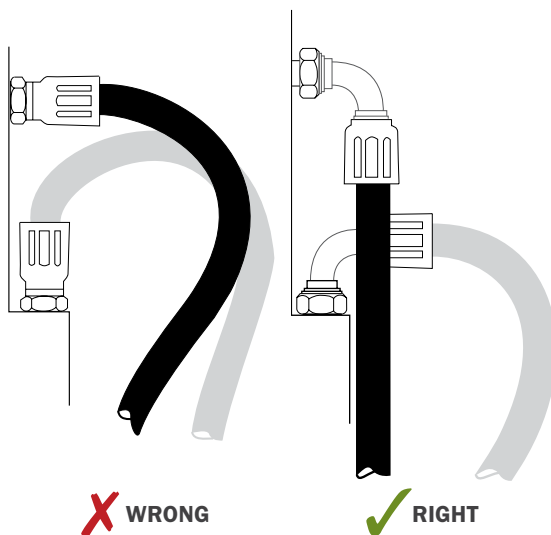

Elbows and adaptors should be used to relieve strain on the assembly, and to provide neater installations which will be more accessible for inspection and maintenance.

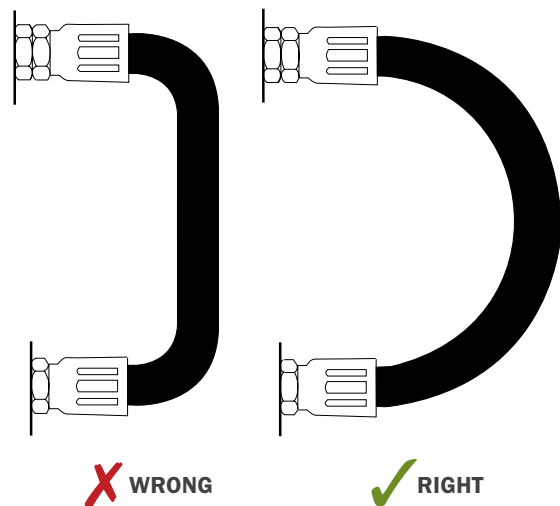

To avoid hose collapse and flow restriction, keep hose bend radii as large as possible. Refer to hose specification tables for minimum bend radii.



RECOMMENDED COUPLING INSTALLATION TORQUE IN NM

Installation torque is important to ensure a proper leak-free seal. Over-torquing of a threaded connection can stretch and damage threads and seat angles. It can also damage the staking area of a nut or possibly break a bolt on the port area. Under-torquing does not allow proper sealing. Torque should always be checked to ensure tightening is within accepted limits. The most reliable method of torquing threaded connections is to first hand-tighten the connection, then use a torque wrench to measure the torque. Torque values vary by thread configuration as follows:

SAE 37° & 45°

MJ, FJX, MIX, FSX

-size	DN		Min.	Max.
-2	3	5/16 - 24	8	10
-3	5	3/8 - 24	11	14
-4	6	7/16 - 20	15	19
-5	8	1/2 - 20	19	24
-6	10	9/16 - 18	24	30
-8	12	3/4 - 16	49	61
-10	16	7/8 - 14	77	96
-12	20	1-1/16 - 12	107	134
-14	22	1-3/16 - 12	127	159
-16	25	1-5/16 - 12	147	184
-20	32	1-5/8 - 12	172	215
-24	38	1-7/8 - 12	215	269
-32	51	2-1/2 - 12	332	415

BSP 60° CONE

MBSPT, MBSPP, FBSPORX

-size	DN		Min.	Max.
-2	3	1/8 - 28	9	12
-4	6	1/4 - 19	15	18
-6	10	3/8 - 19	26	31
-8	12	1/2 - 14	41	49
-10	16	5/8 - 14	50	60
-12	20	3/4 - 14	70	80
-16	25	1 - 11	105	125
-20	32	1-1/4 - 11	170	190
-24	38	1-1/2 - 11	225	250
-32	51	2 - 11	360	420

DIN SERIES

MDL, MDH, MSP, FDLX, FDHX, FDLORX, FDHORX

-size			Min.	Max.
Light Series	Heavy Series			
-6	-	M12 x 1.5	13	17
-8	-6	M14 x 1.5	23	28
-10	-8	M16 x 1.5	33	38
-12	-10	M18 x 1.5	38	42
-	-12	M20 x 1.5	48	52
-15	-14	M22 x 1.5	52	58
-	-16	M24 x 1.5	62	68
-18	-	M26 x 1.5	80	90
-22	-20	M30 x 2	105	115
-28	-25	M36 x 2	125	135
-	-30	M42 x 2	200	220
-35	-	M45 x 2	205	225
-42	-38	M52 x 2	290	310

FLAT-FACED 'O' RING SEAL

FFORX

-size	DN		Min.	Max.
-4	6	9/16 - 18UNF	25	31
-5	8	5/8 - 18UNF	30	38
-6	10	11/16 - 16UN	40	50
-8	12	13/16 - 16UN	55	69
-10	16	1 - 14UNS	60	75
-12	20	1-3/16 - 12UN	90	113
-14	22	1-5/16 - 12UN	-	-
-16	25	1-7/16 - 12UN	125	156
-20	32	1-11/16 - 12UN	170	213
-24	38	2 - 12UN	200	250
-32	51	2-1/2 - 12UN	510	638

O-RING BOSS

MB, MBX

-size	DN		L series		S series.	
			Min.	Max.	Min.	Max.
-2	3	5/16 - 24UNF	8	10	-	-
-3	5	3/8 - 24UNF	10	13	10	13
-4	6	7/16 - 20UNF	18	23	20	25
-5	8	1/2 - 20UNF	25	31	25	31
-6	10	9/16 - 18UNF	30	38	35	44
-8	12	3/4 - 16UNF	50	63	70	88
-10	16	7/8 - 14UNF	60	75	100	125
-12	20	1-1/16 - 12UN	95	119	170	213
-14	22	1-3/16 - 12UN	125	156	215	269
-16	25	1-5/16 - 12UN	150	188	270	338
-20	32	1-5/8 - 12UN	200	250	285	356
-24	38	1-7/8 - 12UN	210	263	370	463
-32	51	2-1/2 - 12UN	300	375	540	675

SAE FLANGES CODE 61

FL

-size	DN		Min.		Max.	
-8	12	M8 x 1.25	32	35		
-12	20	M10 x 1.5	70	77		
-16	25	M10 x 1.5	70	77		
-20	32	M10 x 1.5	70	77		
-24	38	M12 x 1.75	130	143		
-32	51	M12 x 1.75	130	143		
-40	63	M12 x 1.75	130	143		
-48	76	M16 x 2	295	325		
-8	12	5/16 - 18	32	35		
-12	20	3/8 - 16	60	66		
-16	25	3/8 - 16	60	66		
-20	32	7/16 - 14	92	101		
-24	38	1/2 - 13	150	165		
-32	51	1/2 - 13	150	165		
-40	63	1/2 - 13	150	165		
-48	76	5/8 - 11	295	325		

NPTF PIPE

MP

-size	DN		Min.		Max.	
-2	3	1/8 - 27	-	25		
-4	6	1/4 - 18	-	35		
-6	10	3/8 - 18	-	45		
-8	12	1/2 - 14	-	60		
-12	20	3/4 - 14	-	75		
-16	25	1-11 - 1/2	-	90		
-20	32	1-1/4 - 11-1/2	-	110		
-24	38	1-1/2 - 11-1/2	-	410*		
-32	51	2-11-1/2	-	475*		

*Thread sealant used, Gates recommends Vibra-Tite 42050 from ND Industries.

SAE FLANGES CODE 62

FLH

-size	DN		Min.		Max.	
-8	12	M8 x 1.25	32	35		
-12	20	M10 x 1.5	70	77		
-16	25	M12 x 1.75	130	143		
-20	32	M12 x 1.75	130	143		
-20	32	M14 x 2	200	220		
-24	38	M16 x 2	295	325		
-32	51	M20 x 2.5	550	605		
-8	12	5/16 - 18	32	35		
-12	20	3/8 - 16	60	66		
-16	25	7/16 - 14	92	101		
-20	32	1/2 - 13	150	165		
-24	38	5/8 - 11	295	325		
-32	51	3/4 - 10	450	495		

CAUTION

Over-torquing may damage nuts, adapters and sealing seats which may result in leaks, breakage and potential for injury or damage to property.

Applicable to Gates standard couplings with TuffCoat™ plating and assumes threads/seats are dry – with no oil or lubrication. If fitting to an intermediate adaptor, ensure this has been already tightened to a higher torque.

CONVERSION TABLES



HOW TO INTERPRET?

The following table gives rationalised conversion pressures from MPa to psi according to the SAE J517 standard for hydraulic hoses (revised March 2006). These reference pressures allow the user to relate the new MPa pressure number to the former even psi number, 3000 psi relates to 21 MPa with the mathematically correct conversion being 21 MPa equal to 3045 psi. Allowing for the use of the most common available pressures this table will assist in relating the old psi numbers to the new ISO standards that will use either MPa or Bar.

MPA TO PSI

MPa	Bar	Relative psi	Actual psi
3.5	35	500	507.5
7	70	1000	1015
14	140	2000	2030
21	210	3000	3045
28	280	4000	4060
35	350	5000	5075
42	420	6000	6090
49	490	7000	7105

Note: 1MPa = 10 Bar = 145 psi

INCHES - MILLIMETRES

Inches		Millimetres
Fraction	Decimals	
1/64	0.015625	0.397
1/32	0.03125	0.794
3/64	0.046875	1.191
1/16	0.0625	1.588
5/64	0.078125	1.984
3/32	0.09375	2.381
7/64	0.109375	2.778
1/8	0.125	3.175
9/64	0.140625	3.572
5/32	0.15625	3.969
11/64	0.171875	4.366
3/16	0.1875	4.763
13/64	0.203125	5.159
7/32	0.21875	5.556
15/64	0.234375	5.953
1/4	0.250	6.350
17/64	0.265625	6.747
9/32	0.28125	7.144
19/64	0.296875	7.541
5/16	0.3125	7.938
23/64	0.359375	9.128
3/8	0.375	9.525
25/64	0.390625	9.922
13/32	0.40625	10.319
27/64	0.421875	10.716
7/16	0.4375	11.113

Inches		Millimetres
Fraction	Decimals	
29/64	0.453125	11.509
15/32	0.46875	11.906
31/64	0.484375	12.303
1/2	0.500	12.700
33/64	0.515625	13.097
17/32	0.53125	13.494
35/64	0.546875	13.891
9/16	0.5625	14.288
37/64	0.578125	14.684
19/32	0.59375	15.081
39/64	0.609375	15.478
5/8	0.625	15.875
41/64	0.640625	16.272
21/32	0.65625	16.669
11/16	0.6875	17.463
45/64	0.703125	17.859
23/32	0.71875	18.256
47/64	0.734375	18.653
3/4	0.750	19.050
49/64	0.765625	19.447
25/32	0.78125	19.844
51/64	0.796875	20.241
13/16	0.8125	20.638
53/64	0.828125	21.034
27/32	0.84375	21.431
55/64	0.859375	21.828
7/8	0.875	22.225
57/64	0.890625	22.622
29/32	0.90625	23.019
59/64	0.921875	23.416
15/16	0.9375	23.813
61/64	0.953125	24.209
31/32	0.96875	24.606
63/64	0.984375	25.003



METRIC (SI) - IMPERIAL UNITS FOR HOSE AND CONNECTORS USE

Quantity	Imperial unit	Metric (SI) unit	Conversion from imperial to SI unit	Conversion from SI to imperial unit
Area	Square inch (in ²)	Square metre (m ²)	(in ²) x (6.4516 x 10 ⁻⁴) = (m ²)	(m ²) x 1550.003 = (in ²)
Force	Pound (lbf)	Newton (N)	(lbf) x 4.4482 = (N)	(N) x (2.2481 x 10 ⁻¹) = (lbf)
Frequency	Cycles/second (cps)	Hertz (Hz)	1 (cps) = 1 (Hz)	1 (Hz) = 1 (cps)
Length	Inch (in)	Metre (m)	(in) x (2.540 x 10 ⁻²) = (m)	(m) x 39.370 = (in)
Mass	Pound (lbm)	Kilogram (kg)	(lbm) x 0.4536 = (kg)	(kg) x 2.2046 = (lbm)
Power	Electric horsepower (HP)	Watt (W)	(HP) x (7.460 x 10 ²) = (W)	(W) x (1.3405 x 10 ⁻³) = (HP)
Pressure	Pounds/sq in (psi)	Newtons/sq metre (N/m ²)	(psi) x (6.8948 x 10 ³) = (N/m ²)	(N/m ²) x (1.4504 x 10 ⁻⁴) = (psi)
	(psi)	Mega Pascal (MPa)	(Non-preferred conversions) psi/145 = MPa	(MPa) x 145 = (psi)
	(psi) (bar)	Bar (bar) (N/m ²)	psi/14.5 = bar (bar) x 100000 = (N/m ²)	(bar) x (1.4504 x 10 ¹) = (psi) (N/m ²) x (1.00 x 10 ⁻⁵) = (bar)
Temperature	Degrees Fahrenheit (°F)	Degrees Celsius (°C)	(°Celsius) = 0.556 (°F-32)	(1.8°C) + 32 = °F
Torque	Pound-inch (lbf-in)	Newton-metres (Nm)	(lbf-in) x (1.1298 x 10 ⁻¹) = (Nm)	(Nm) x 8.8507 = (lbf-in)
Volume	US gallon (gal)	Cubic metre (m ³)	(gal) x (4.543 x 10 ⁻³) = (m ³)	(m ³) x (2.201 x 10 ²) = (gal)
		Litre (l)	(Non-preferred conversions) (gal) x 4.543 = (l)	(l) x (2.201 x 10 ⁻¹) = (gal)
Work	Foot-pound (ft-lbf)	Joule (J)	(ft-lbf) x 1.3558 = (J)	(J) x (7.3756 x 10 ⁻¹) = (ft-lbf)

TABLE OF CONTENTS

ABOUT GATES

HYDRAULIC HOSE

HYDRAULIC HOSE COUPLINGS

ENGINEERING AND TECHNICAL DATA

WARNING



WARNING

 **Hydraulic fluid under pressure is potentially dangerous!**

Serious injury, death and destruction of property can result from the rupture or other failure of a hose assembly that is:

- damaged or worn out;
- assembled or installed incorrectly.

 **Protect yourself and others.**

- Ensure you are properly trained in the use of Gates hose, couplings and assembly equipment.
- Use correct crimp information. Ensure your assembly equipment is properly maintained and calibrated.
- Use only (unused) Gates hose and coupling products and Gates assembly equipment. Never mix products from different manufacturers.
- Use safety glasses and safety protection.

 **Hose selection and installation.**

- Basic notes and advice are included in this publication.
- Consult Gates Safe Hydraulics Manual (E2/50092) for detailed selection and installation advice.

 **Regularly inspect hose assemblies for defects or signs of wear or ageing.**

Product life will be influenced by:

- severity of application;
- frequency of equipment use.

 **Avoid injury.**

- Always position a shield between yourself and any pressurised hydraulic lines when working close to hydraulic systems - or shut off the pressure.
- Never touch or work on pressurised hydraulics or hose assemblies.
- Do not use hands to check for leaks.
- Stay out of hazardous areas, including machine operating areas, when testing hose assemblies.
- Remember that some hydraulic fluids are highly flammable.

If an injury occurs, particularly one where hydraulic fluid may have punctured the skin, seek medical assistance immediately.

 **Nominal dimensions.**

All dimensions are nominal, do not use for inspection. We reserve the right to amend dimensions without notice. Please consult your Gates price list for product stock classification.

 **Caution!**

Gates recommends only those hose and coupling combinations specified in the Gates hydraulic products catalogues. Gates disclaims all liability for any hose assemblies which have not been produced in conformance with Gates assembly recommendations and correct crimp data charts, or are incorrectly installed. Extensive testing has been done to verify the recommendations shown. Evaluation of a hose and coupling combination requires extensive impulse testing and cannot be determined by a simple burst or pressure hold test.

Any claim for defects must follow the RR (Return Report) procedure (information from your sales coordinator), to enable Gates to assess, report and act upon any alleged defect.

WARNING



Hose Shelf Life

Hose in storage can deteriorate to the point where they fail immediately or prematurely after being taken out of storage. The storage conditions, along with the rubber materials, can change the shelf life limit. Some hose materials such as EPDM have a tendency to last longer in storage due to the inherent resistance characteristics of the material. But there are many more variables affecting hose storage, making hose shelf life a value that is hard to quantify.

Standards SAE J517, SAE J1273, BS 5244, ISO 2230 and ISO 8331 provide guidelines for hose storage and age control. Refer to these specifications, and note that some storage precautions can support in the optimum shelf life.

Stored hose must not be subjected to damage that could reduce their expected service life and must be placed in a cool, dark and dry area with the ends capped. Stored hose must not be exposed to temperature extremes, ozone, oils, corrosive liquids or fumes, solvents, high humidity, rodents, insects, ultraviolet light, electromagnetic fields or radioactive materials.

The storage period should be kept to a minimum, rotation of stock is therefore essential. Hose must be stored in a manner that facilitates age control and first-in and first-out usage based on manufacturing date of the hose. Before fitting, all hose should be subjected to visual examination for evidence of deterioration. The shelf life of rubber Hydraulic hose that have passed visual inspection follow below recommendation scheme from the date of manufacture. The shelf life of thermoplastic Hydraulic hose is considered to be unlimited. For non-hydraulic hose applications such as engine hoses and industrial hoses Gates shelf life recommendation is set at maximum 8 years from the date of manufacture.

Test recommendations for hoses	
Age	Recommendations (if stored in accordance with ISO 8331)
Up to 4 years	Use without further testing
4 to 6 years	Use after representative samples subjected to a proof pressure test
6 to 8 years	Use after representative samples subjected to proof, impulse and burst pressure tests, and cold bend and electrical tests
Over 8 years	Scrap

WARNING



LISTING OF GATES RESTRICTED APPLICATIONS

The purpose of this list is to identify applications for which Gates will not recommend product. These applications have been identified as having risk potential beyond that which is acceptable. In general, Gates does not make or sell products suitable for most of these uses. These applications involve potential for severe injury, loss of life and/or high damage. In most instances, they involve uses that cannot be monitored or serviced to control against catastrophic breaks and ruptures of the hose assembly. This list also identifies recommended responses to inquiries involving these applications.

SCOPE AND APPLICABILITY

This list encompasses hose and hose assembly applications in industrial, hydraulic and automotive markets. It is not considered all-inclusive, but represents applications that exceed the maximum acceptable level of risk. Predicting new applications that could also exceed limits of risk is difficult; therefore, this list also identifies characteristics that should be considered in evaluating other inquiries.

RESPONSIBILITY

Gates personnel and distributors are expected to respond to inquiries with the information in this document. They should also help define and identify other applications that carry these risk factors. Sales associates consult with a product application engineer before handling inquiries about excessively risky applications.

PROCEDURE OR WORK INSTRUCTION

The table on the following page lists applications that have sufficiently high damage or safety risks so as to be avoided. This list is not inclusive. If an application is not specifically listed but has similar risk factors to those shown, no Gates product will be recommended without prior written approval by a member of Gates Product Application Engineering.

WARNING



APPLICATION	APPLICATION
Certain Types of Hazardous Materials Alkali Metals (Lithium, Sodium, Potassium) Nerve gases Anhydrous Ammonia Chlorine Gas Chlorosulfonic Acid Fluorine Gas Hydrogen Gas Hydrogen Sulfide Gas Malic Acid Mercury Vapor Phosphorus Cryogenic atmospheric gases (liquefied oxygen, nitrogen)	Death or serious injury can result from toxic exposure, burns, and suffocation of operator or bystanders.
Hydraulic brake systems that require the hose to meet the SAE J1401 standard.	Gates does not sell hydraulic brake hoses or fittings where liquid pressure is used to activate the brake system and stop the vehicle. Loss of braking from an improper hose can result in property damage, serious injury or death to operator, passengers and bystanders.
High Pressure gas or air (over 500 psi), unless steam.	Death or serious injury from explosive decompression. Reduced serviceability due to permeation and cover separations.
In-flight aircraft (airborne), manned and unmanned applications.	Death or serious injury from loss of flightworthiness caused by system failure.
Buried Applications	Hidden from regular inspection and maintenance. Environmental damage. Permeation of material conveyed to surface.
Underwater applications, such as submarine transfer and some dock to ship applications.	Hidden from regular inspection and maintenance. Environmental damage. Permeation of material conveyed to surface.
Any "permanent" installations.	Hose has limited service life. Hidden from regular inspection and maintenance. High replacement costs. Costly structural damage.
In-floor and in-wall radiant heat applications.	Hidden from regular inspection and maintenance. High replacement costs. Costly structural damage.
Out of sight applications, especially in commercial buildings, for which inspection is not convenient or possible.	Hidden from regular inspection/maintenance. High replacement costs. Costly structural damage.
"Mix and Match" Hydraulic Hose and Couplings. (Using coupling and hose combinations not specifically recommended by Gates.)	Component Compatibility – Unknown performance. Death or serious injury from ejected couplings.
Reusable couplings on LPG hose.	Death or serious injury from Fire and Suffocation risks.

TABLE OF CONTENTS

ABOUT GATES

HYDRAULIC HOSE

HYDRAULIC HOSE COUPLINGS

ENGINEERING AND TECHNICAL DATA



DEFINITIONS

APPLICATION – The use of product for specific purposes. An application is defined by the size of hose, temperature range, the purpose it serves, the material conveyed, the operating pressure and cycles, the end terminations and fluid dynamics. Other environmental and operating conditions may also be specified as well.

BRAKE SYSTEMS – The use of hydraulic brake systems per SAE J1401 where liquid pressure is used to activate the brake systems are restricted. Hydraulic brake systems that use a liquid but not pressure (gravity etc.) are acceptable such as between the reservoir and cylinder. Air brake systems per SAE J1402 and SAE J844 where air pressure is used to activate the brake systems are acceptable. Vacuum brake systems per SAE J1403 where a vacuum is used to activate the brake systems are acceptable.

BURIED APPLICATION – An application that is underground or involves covering the hose assembly with earth, sand, gravel, mud, concrete or similar materials.

HOSE ASSEMBLY – The combination of a hose and its couplings (accessories such as sleeves, guards, and bend restrictors should also be considered where required or desirable).

IN-FLIGHT AIRCRAFT APPLICATION – Any application that involves any airborne system having both end connections on an aircraft while operating off of the ground whether manned or unmanned. This includes helicopters, drones, lighter than air craft (balloons), missiles, experimental aircraft, and gliders. This does not include aircraft servicing applications that are used and connected to ground based equipment while the aircraft, airborne equipment or machine is on the ground, for example, for refueling service.

IN-FLOOR AND IN-WALL RADIANT HEAT APPLICATION – Any application for providing heat through walls and floors of structures or roads and driveways by carrying fluids.

“MIX AND MATCH” – The use of unqualified or unsuitable hose, end-fitting or other coupling components with Gates components. For example, a competitor’s stem and ferrule on a Gates hose, Gates end-fittings on a competitor’s hose, or Gates end-fitting on a Gates hose in a way not recommended by Gates crimp data.

OUT OF SIGHT APPLICATION – Any application where the assembly is not visible for regular inspection or preventative maintenance.

PERMANENT INSTALLATION – Any application where the assembly is never expected to wear out or to be replaced. These can also be applications where the expected service life of the assembly is shorter than the application’s reasonable inspection or maintenance interval.

PERMEATION – The migration or diffusion of fluids (liquids, gases) through the hose wall. Directions can be inward as well as outward. For example, a hose carrying LPG will allow diffusion of LPG through the hose wall into the environment. Also, water can migrate into an air conditioning system through the hose wall.

RISK ANALYSIS – A systematic evaluation of the business, safety and legal exposure of an application.

RISK FACTOR – An element contributing to the chance of injury or loss. A hazard or dangerous chance.

UNDERWATER APPLICATION – An application that is under the surface of a body of water or covered by water.



DRIVEN BY POSSIBILITY™

CUSTOMER EXPERIENCE TEAM

+48767235200
INFOREQUEST@GATES.COM

THE MANUFACTURERS RESERVE THE RIGHT TO AMEND DETAILS WHERE NECESSARY.
E2/50080 - ©GATES 2024 - PRINTED IN BELGIUM - 01/24.

GATES.COM