



Belt Sizing Guide

Belt Sizing Guide

Many conveying timing belts operate at low speeds and minimal loads. This eliminates the need for extensive calculations and a simplified approach to belt selection can be used. For these lightly loaded applications, the belt can be selected according to the dimensional requirements of the system, product size, desired pulley diameter, conveyor length, etc.

The belt width **b** is often determined according to the size of the product conveyed, and as a rule, the smallest available belt pitch is used. For proper operation, the pre-tension T_i should be set as follows:

$$T_i \approx 0.3 \cdot b \cdot T_{1all}$$

where: T_i = belt pre-tension
 T_{1all} = max allowable belt tension for 1" or 25mm wide belt (see Table 1 or Table 2)

U.S. customary units: T_i [lb], T_{1all} [lb/in], b [in]
 Metric units: T_i [N], T_{1all} [N/25mm], b [mm].

For all applications where the loads are significant, the following step-by-step procedure should be used for proper belt selection.

Step 1. Determine Effective Tension

The effective tension T_e at the driver pulley is the sum of all individual forces resisting the belt motion. The individual loads contributing to the effective tension must be identified and calculated based on the loading conditions and drive configuration. However, some loads cannot be calculated until the layout has been decided.

To determine the effective tension T_e use one of the following methods for either conveying or linear positioning.

Conveying

T_e for conveying application is primarily the sum of the following forces (see Figs. 1 and 2).

1. The friction force F_f between the belt and the slider bed resulting from the weight of the conveyed material.

$$F_f = \mu \cdot w_m \cdot L_m \cdot \cos\beta$$

where: μ = coefficient of friction between the slider bed and the belt (see Table 1A)

w_m = load weight per unit length over conveying length

L_m = conveying length

β = angle of conveyor incline

U.S. customary units: F_f [lb], w_m [lb/ft], L_m [ft].

Metric units: F_f [N], w_m [N/m], L_m [m].

2. The gravitational load F_g to lift the material being transported on an inclined conveyor.

$$F_g = w_m \cdot L_m \cdot \sin\beta$$

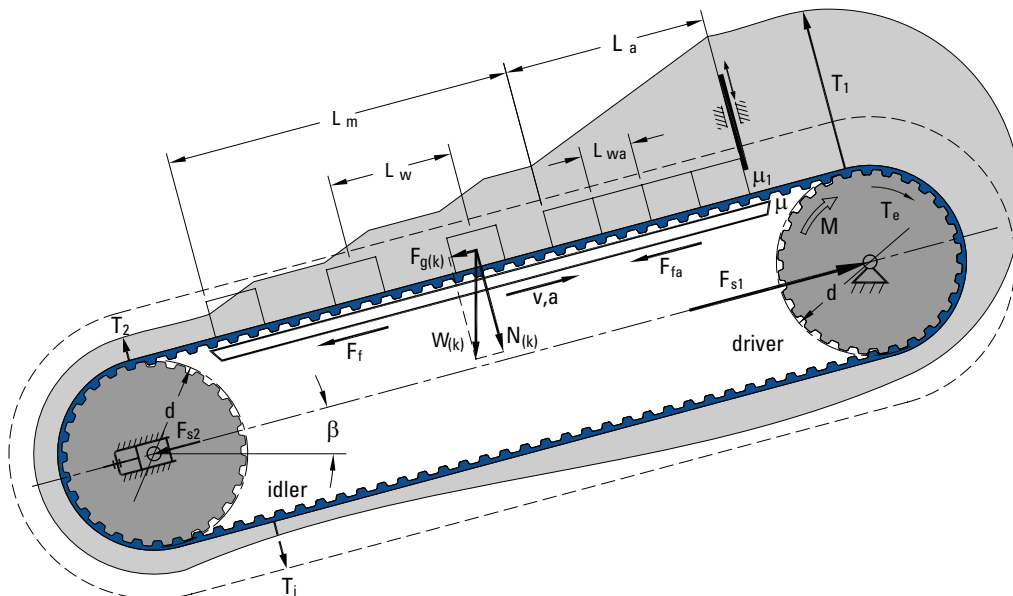

Fig. 1

Belt Sizing Guide

5. The force F_{ai} required to accelerate the idler.

$$F_{ai} = \frac{J_i \cdot \alpha}{r_o} = \frac{m_i \cdot r_o^2}{2 \cdot r_o} \cdot \frac{a}{r_o} = \frac{m_i \cdot a}{2}$$

where: $J_i = \frac{m_i \cdot r_o^2}{2}$ = inertia of the idler
 m_i = mass of the idler
 r_o = idler outer radius
 $\alpha = \frac{a}{r_o}$ = angular acceleration

In the formula above, the mass of the idler m_i is approximated by the mass of a full disk.

$$m_i = \rho \cdot b_i \cdot \pi \cdot r_o^2$$

where: ρ = density of idler material
 b_i = width of the idler

U.S. units: ρ [lb•s²/ft⁴], b_i and r_o [ft].
 Metric units: ρ [kg/m³], b_i and r_o [m].

6. The force F_{ab} required to accelerate the belt mass.

$$F_{ab} = m_b \cdot a$$

The belt mass m_b is obtained from the specific belt weight w_b and belt length and width.

$$m_b = \frac{w_b \cdot L \cdot b}{g}$$

U.S. units: F_{ab} [lb], m_b [lb•s²/ft], a [ft/s²], w_b [lb/ft²], L and b [ft],

$$g = 32.2 \text{ ft/s}^2.$$

Metric units: F_{ab} [N], m_b [kg], a [m/s²], w_b [N/m²], L and b [m],

$$g = 9.81 \text{ m/s}^2.*$$

Thus for linear positioners, T_e is expressed by:

$$T_e = F_a + F_f + F_w + W_s + [F_{ai}] + [F_{ab}]$$

Note that the forces in brackets can be calculated by estimating the belt mass and idler dimensions. In most cases, however, they are negligible and can be ignored.

Step 2. Select Belt Pitch

Use Graphs 2a, 2b, 2c or 2d to select the nominal belt pitch p according to T_e . The graphs also provide an estimate of the required belt width. (For H pitch belts wider than 6" (152.4mm) and T10 pitch belts wider than 150mm, use Graph 1).

Step 3. Calculate Pulley Diameter

Use the preliminary pulley diameter \bar{d} desired for the design envelope and the selected nominal pitch p to determine the preliminary number of pulley teeth \bar{z}_p .

$$\bar{z}_p = \frac{\pi \cdot \bar{d}}{p}$$

Round to a whole number of pulley teeth z_p . Give preference to stock pulley diameters. Check against the minimum number of pulley teeth z_{min} for the selected pitch given in Table 1 or Table 2.

Determine the pitch diameter d according to the chosen number of pulley teeth z_p .

$$d = \frac{p \cdot z_p}{\pi}$$

Step 4. Determine Belt Length and Center Distance

Use the preliminary center distance \bar{C} desired for the design envelope to determine a preliminary number of belt teeth \bar{z}_b .

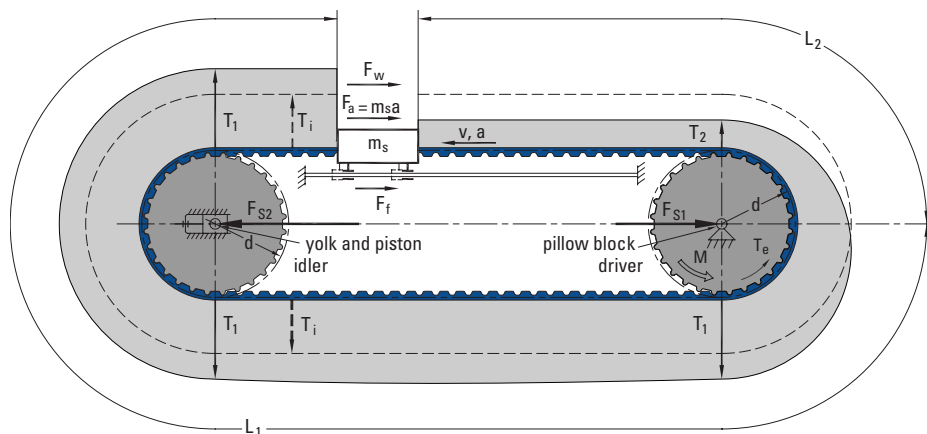

Fig. 3

Belt Sizing Guide

3. The friction force F_{fv} resulting from vacuum in vacuum conveyors.

$$F_{fv} = \mu \cdot P \cdot A_v$$

where: P = pressure (vacuum) relative to atmospheric
 A_v = total area of vacuum openings

U.S. units: F_{fv} [lb], P [lb/ft²], A_v [ft²]

Metric units: F_{fv} [N], P [Pa], A_v [m²]

The formula above assumes a uniform pressure and a constant coefficient of friction.

4. The friction force F_{fa} over the accumulation length in material accumulation applications.

$$F_{fa} = (\mu + \mu_a) \cdot w_{ma} \cdot L_a \cdot \cos\beta$$

where: L_a = accumulation length
 μ_a = friction coefficient between accumulated material and the belt (see Table 1A)

w_{ma} = material weight per unit length over the accumulation length

U.S. customary units: L_a [ft], w_{ma} [lb/ft]

Metric units: L_a [m], w_{ma} [N/m]

5. The inertial force F_a caused by the acceleration of the conveyed load (see linear positioning).

6. The friction force F_{fb} between belt and slider bed caused by the belt weight.

$$F_{fb} = \mu \cdot w_b \cdot b \cdot L_c \cdot \cos\beta$$

where: w_b = specific belt weight
 b = belt width
 L_c = conveying length

U.S. customary units: w_b [lb/ft²], b [ft], L_c [ft]

Metric units: w_b [N/m²], b [m], L_c [m].*

For initial calculations, use belt width which is required to handle the size of the conveyed product.

Thus for conveyors, T_e is expressed by:

$$T_e = F_f + F_g + F_{fv} + F_{fa} + F_a + (F_{fb}) + \dots$$

F_{fb} can be calculated by estimating the belt mass. In most cases, this weight is insignificant and can be ignored.

Note that other factors, such as belt supporting idlers, or accelerating the material fed onto the belt,

* If working in US units, w_b found in the belt specifications must be converted to the units lb/ft². If working in metric units, w_b must be converted to the units N/m².

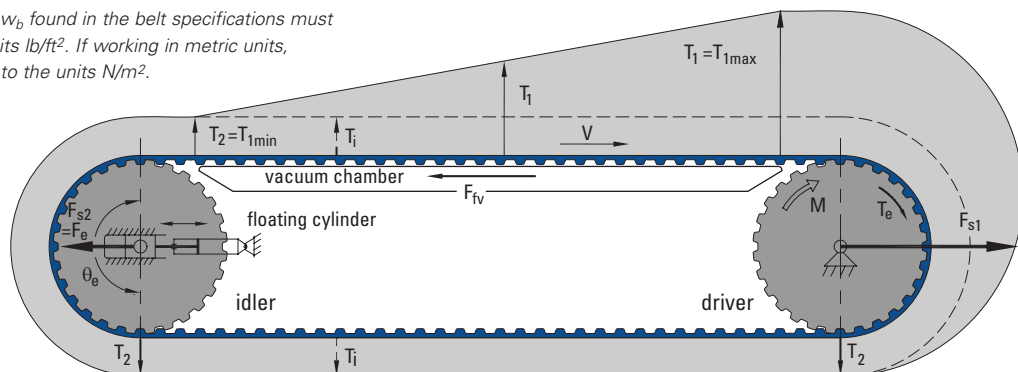

Fig. 2

may also account for some power requirement. In start-stop applications, acceleration forces as presented for linear positioning, may have to be evaluated.

Linear Positioning

T_e for a linear positioning application is primarily the sum of the following six factors (see Fig. 3).

1. The force F_a required for the acceleration of a loaded slide with the mass m_s (replace the mass of the slide with the mass of the package in conveying).

$$F_a = m_s \cdot a$$

The average acceleration a is equal to the change in velocity per unit time.

$$a = \frac{v_f - v_i}{t}$$

where: v_f = final velocity
 v_i = initial velocity
 t = time

U.S. customary units: F_a [lb], a [ft/s²], v_f and v_i [ft/s] t [s].
 The mass is derived from the weight W_s [lb] and the acceleration due to gravity g ($g = 32.2$ ft/s²):

$$m_s = \frac{W_s}{g} = \frac{W_s}{32.2} \left[\frac{\text{lb} \cdot \text{s}^2}{\text{ft}} \right]$$

Metric units: F_a [N], a [m/s²], v_f and v_i [m/s], t [s], m_s [kg].

2. The friction force F_f between the slide and the linear rail is determined experimentally, or from data from the linear bearing manufacturer. Other contributing factors to the friction force are bearing losses from the yolk, piston and pillow blocks (see Fig. 3).

3. The externally applied working load F_w (if existing).

4. The weight W_s of the slide (not required in horizontal drives).

Belt Sizing Guide

For equal diameter pulleys:

$$\bar{z}_b \approx 2 \cdot \frac{\bar{C}}{p} + z_p$$

For unequal diameter pulleys: (See Fig. 4)

$$\bar{z}_b \approx 2 \cdot \frac{\bar{C}}{p} + \frac{z_{p2} + z_{p1}}{2} + \frac{p}{4C} \cdot \left(\frac{z_{p2} - z_{p1}}{\pi} \right)^2$$

Choose a whole number of belt teeth z_b . If you have profiles welded to the belt, consider the profile spacing while choosing the number of belt teeth.

Determine the belt length L according to the chosen number of belt teeth.

$$L = z_b \cdot p$$

Determine the center distance C corresponding to the chosen belt length.

For equal diameter pulleys:

$$C = \frac{L - \pi \cdot d}{2}$$

For unequal diameter pulleys:

$$C \approx \frac{Y + \sqrt{Y^2 - 2(d_2 - d_1)^2}}{4}$$

$$\text{where: } Y = L - \frac{\pi \cdot (d_2 + d_1)}{2}$$

Step 5. Calculate The Number of Teeth in Mesh of the Small Pulley

Calculate the number of teeth in mesh z_m , using the appropriate formula.

For two equal diameter pulleys:

$$z_m = \frac{z_p}{2}$$

For two unequal diameter pulleys:

$$z_m \approx z_{p1} \cdot \left(0.5 - \frac{d_2 - d_1}{2\pi \cdot C} \right)$$

Step 6. Determine Pre-tension

The pre-tension T_i , defined as the belt tension in an idle drive, is illustrated as the distance between the belt and the dashed line in Figs. 1, 2, and 3. The pre-tension prevents jumping of the pulley teeth during belt operation. Based on experience, timing belts perform best with the slack side tension as follows:

$$T_2 = (0.1, \dots, 0.3) T_e$$

Drives with a fixed center to center distance

Drives with fixed center distances have the position of the adjustable shaft locked after pre-tensioning the belt (see Figs. 1 and 3). Assuming tight and slack side tensions are constant over the respective belt lengths, and a minimum slack side tension in the range of the above relationship (uni-directional load only), the pre-tension is calculated utilizing the following equation:

$$T_i = T_2 + T_e \cdot \frac{L_1}{L}$$

where: L = belt length = $L_1 + L_2$

L_1 = tight side belt length

L_2 = slack side belt length

U.S. units: L_1 [ft], and L_2 [ft].

Metric units: L_1 [m], and L_2 [m].

Drives with a fixed center to center distance are used in linear positioning, conveying and power transmission applications. In linear positioning applications, the maximum tight side length is inserted in the equation above.

The pre-tension for drives with a fixed center distance can also be approximated using the

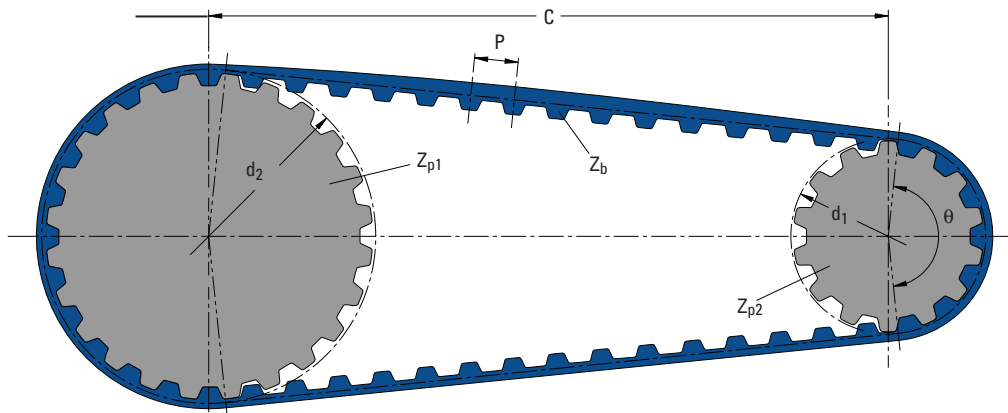

Fig. 4

Belt Sizing Guide

following formulas:

Conveying

(see Figs. 1 and 2)

$$T_i = (0.45, \dots, 0.55) T_e$$

Linear Positioning

(see Fig. 3)

$$T_i = (1.0, \dots, 1.2) T_e$$

$$T_i = (1.0, \dots, 2.0) T_e \Rightarrow \text{for ATL series only}$$

Drives with a constant slack side tension

Drives with constant slack side tension have an adjustable idler, tensioning the slack side, which is not locked (Figs. 2 and 5). During operation, the consistency of the slack side tension is maintained by the external tensioning force, F_e . Drives with a constant slack side tension may be considered for some conveying applications, they have the advantage of minimizing the required pre-tension.

The minimum pre-tension can be calculated from the analysis of the forces at the idler in Fig. 5:

$$T_i \approx T_2 = \frac{F_e}{2 \sin \frac{\theta_e}{2}}$$

where θ_e is the wrap angle of the belt around the back bending idler (Fig. 5).

Step 7. Calculate Tight Side Tension and Slack Side Tension

Conveying

(see Figs. 1 & 2)

The tight side tension T_1 and the slack side tension

T_2 are obtained by:

$$T_1 \approx T_i + 0.75 T_e$$

$$T_2 = T_1 - T_e$$

Linear Positioning

(see Fig. 3)

The maximum tight side tension T_{1max} is obtained by:

$$T_{1max} \approx T_i + T_e$$

The respective minimum slack side tension T_{2min} is obtained by:

$$T_{2min} \approx T_i - T_e$$

for a fixed center distance.

Step 8. Calculate Belt Width

Determine the allowable tension T_{1all} for the cords of a 1" (or 25 mm) wide belt of the selected pitch given in Table 1 or Table 2. Note that T_{1all} is different for open end (positioning) and welded (conveying) belts. Determine the necessary belt width to withstand T_{1max} :

$$b \geq \frac{T_{1max}}{T_{1all}}$$

U.S. units: T_1 [lb], T_{1all} [lb/in], b [in].

Metric units: T_1 [N], T_{1all} [N/25mm], b [mm].

Determine the allowable effective tension T_{eall} for the teeth of a 1" (or 25 mm) wide belt of the selected pitch from Table 1 or Table 2. Note that T_{eall} is different for open end (positioning) and welded (conveying) belts.

Use Table 3 (Tooth in Mesh Factor) that follows to determine the tooth-in-mesh-factor t_m corresponding to the number of teeth in mesh z_m .

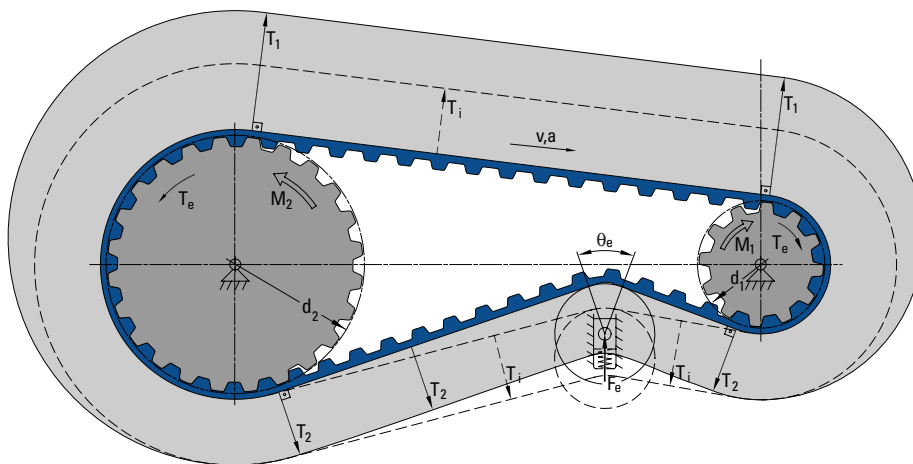

Fig. 5

Belt Sizing Guide

Determine the speed factor t_v using Table 4 (Speed Factor) that follows.

Calculate the width of the belt teeth b necessary to transmit T_e using the following formula:

$$b \geq \frac{T_e}{T_{eall} \cdot t_m \cdot t_v}$$

U.S. units: T_e [lb], T_{eall} [lb/in], b [in].

Metric units: T_e [N], T_{eall} [N/25mm], b [mm].

Select the belt width that satisfies the last two conditions, giving preference to standard belt widths. However, belts of nonstandard widths are also available.

The factors t_m and t_v prevent excessive tooth loading and belt wear.

The forces contributing to T_e , which in Step 1 were estimated, can now be calculated more accurately. Evaluate the contribution of these forces to the effective tension and, if necessary, recalculate T_e and repeat steps 6, 7 and 8.

For conveyors, the dimensions of the transported products will normally determine the belt width.

Step 9. Calculate Shaft Forces

Determine the shaft force F_{s1} at the driver pulley:

For angle of wrap $\theta = 180^\circ$:

$$F_{s1} = T_1 + T_2$$

For angle of wrap around the small pulley $\theta < 180^\circ$ (unequal diameter pulleys):

$$F_{s1} = \sqrt{T_1^2 + T_2^2 - 2T_1 \cdot T_2 \cos\theta}$$

$$\text{where } \theta = 2 \cdot \pi \cdot \left(0.5 - \frac{d_2 - d_1}{2 \cdot \pi \cdot C}\right)$$

Determine the shaft force F_{s2} at the idler pulley:

For angle of wrap $\theta = 180^\circ$:

$F_{s2} = 2 \cdot T_2$ when load moves toward the driver pulley, and

$F_{s2} = 2 \cdot T_1$ when load moves away from the driver pulley.

For angle of wrap around the small pulley

$\theta < 180^\circ$ (unequal diameter pulleys):

$F_{s2} = T_2 \cdot \sqrt{2(1 - \cos\theta)}$ when load moves toward the driver and

$F_{s2} = T_1 \cdot \sqrt{2(1 - \cos\theta)}$ when the load moves away from the driver.

Step 10. Calculate the Stiffness of a Linear Positioner

The total stiffness of the belt depends mainly on the stiffness of the belt segments between the pulleys. In most cases, the influence of belt teeth and belt cords in the tooth-in-mesh area can be ignored.

Calculate the resultant stiffness coefficient of tight and slack sides k , as a function of the slide position (Fig. 6).

$$k = c_{sp} \cdot b \cdot \frac{L}{L_1 \cdot L_2}$$

where: L_1 = tight side length
 L_2 = slack side length
 c_{sp} = specific stiffness (Table 1).

U.S. units: k [lb/in], c_{sp} [lb/in], b [in], L [in].

Metric units: k [N/mm], c_{sp} [N/mm], b [mm], L [mm].

Note that k is at its minimum when the tight and slack sides are equal.

Determine the positioning error Δx due to belt elongation caused by the remaining static force F_{st} on the slide:

$$\Delta x = \frac{F_{st}}{k}$$

In Fig. 6, for example, F_{st} is comprised of F_f and F_w and is balanced by the static effective tension T_{est} at the driver pulley.

Note that Δx is inversely proportional to the belt width. If you want reduced Δx , increase the belt width or select a belt with stiffer cords and/or with a larger pitch.

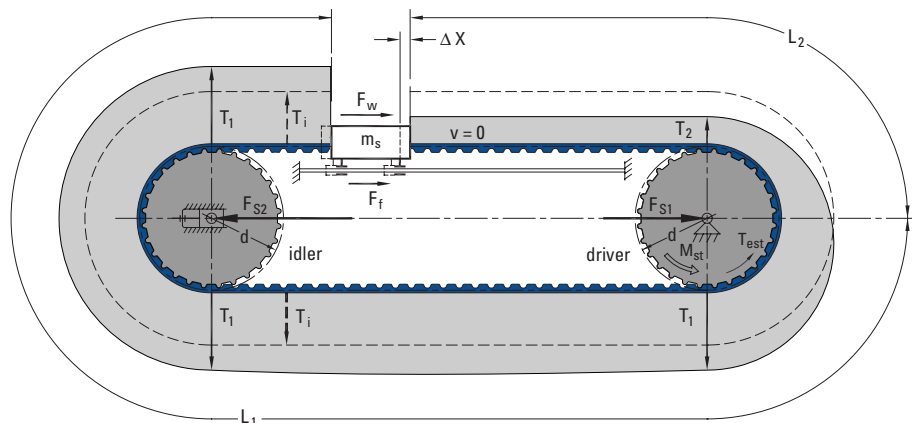
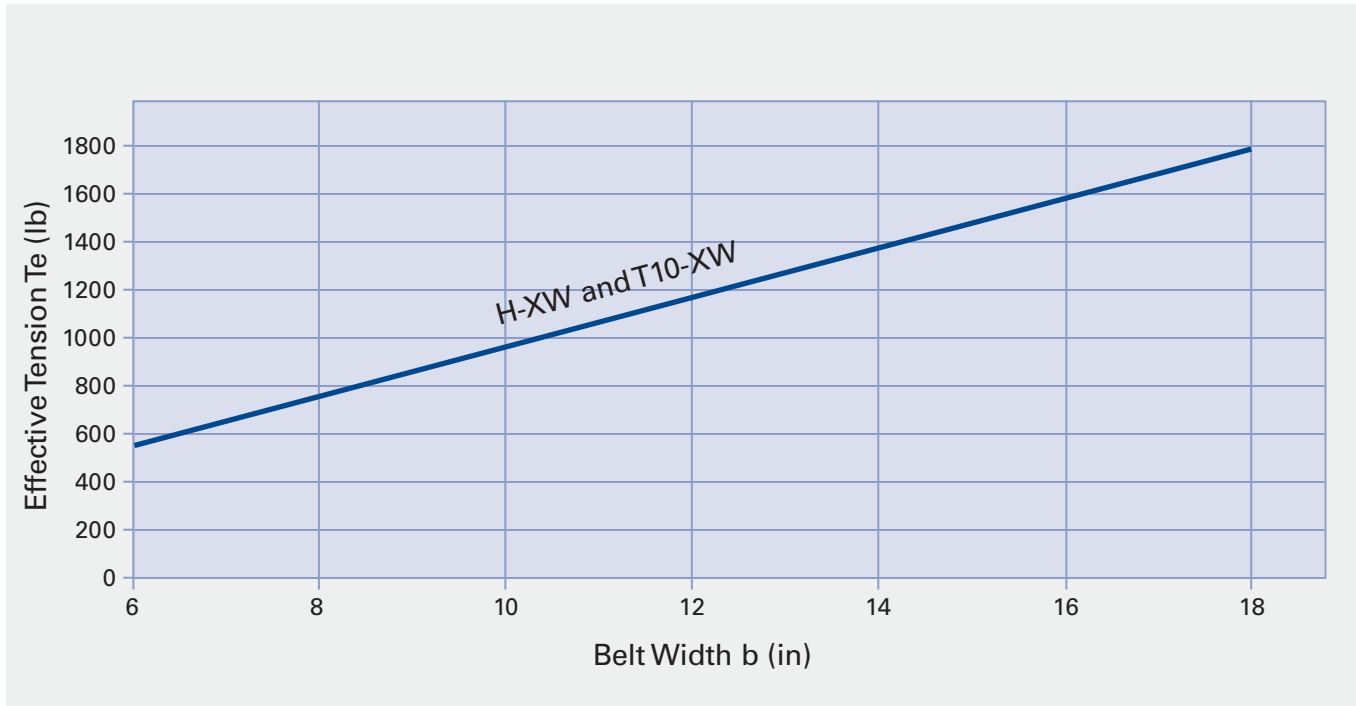

Fig. 6

Technical Design Tools



Graph 1

Tooth In Mesh Factor

No. of Teeth in Mesh z_m	Tooth in Mesh Factor t_m
3	0.39
4	0.5
5	0.59
6	0.67
7	0.74
8	0.8
9	0.85
10	0.89
11	0.92
12	0.95
13	0.97
14	0.99
15	1

Table 3

Speed Factor

Speed		Speed Factor t_v
ft/min	m/s	
0	0	1
200	1	0.99
400	2	0.98
600	3	0.97
800	4	0.95
1000	5	0.93
1200	6	0.9
1400	7	0.87
1600	8	0.84
1800	9	0.81
2000	10	0.77

Table 4

Technical Design Tools

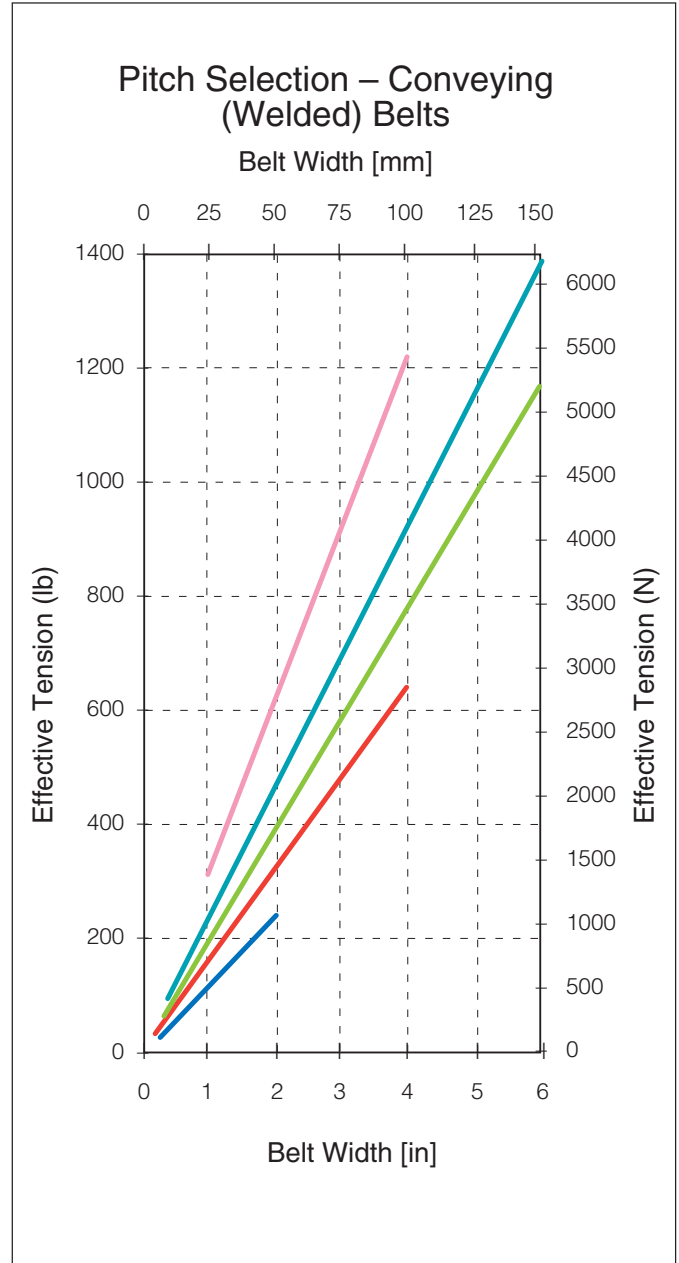
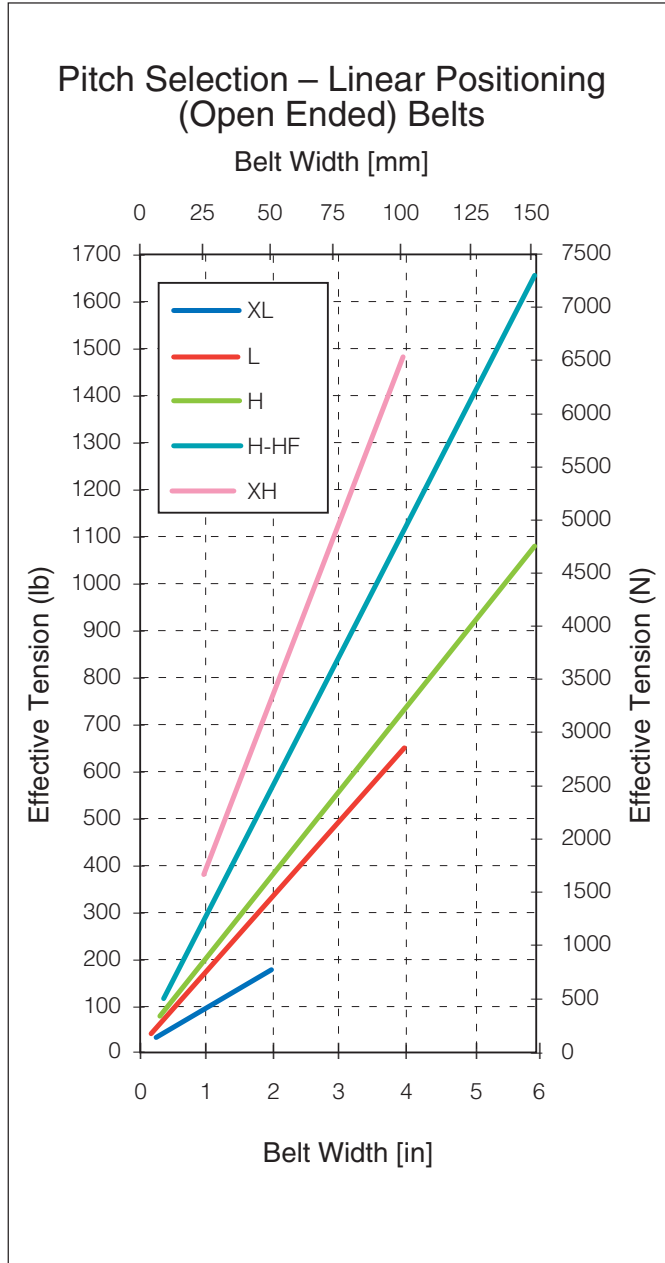

GRAPH 2a

Technical Design Tools

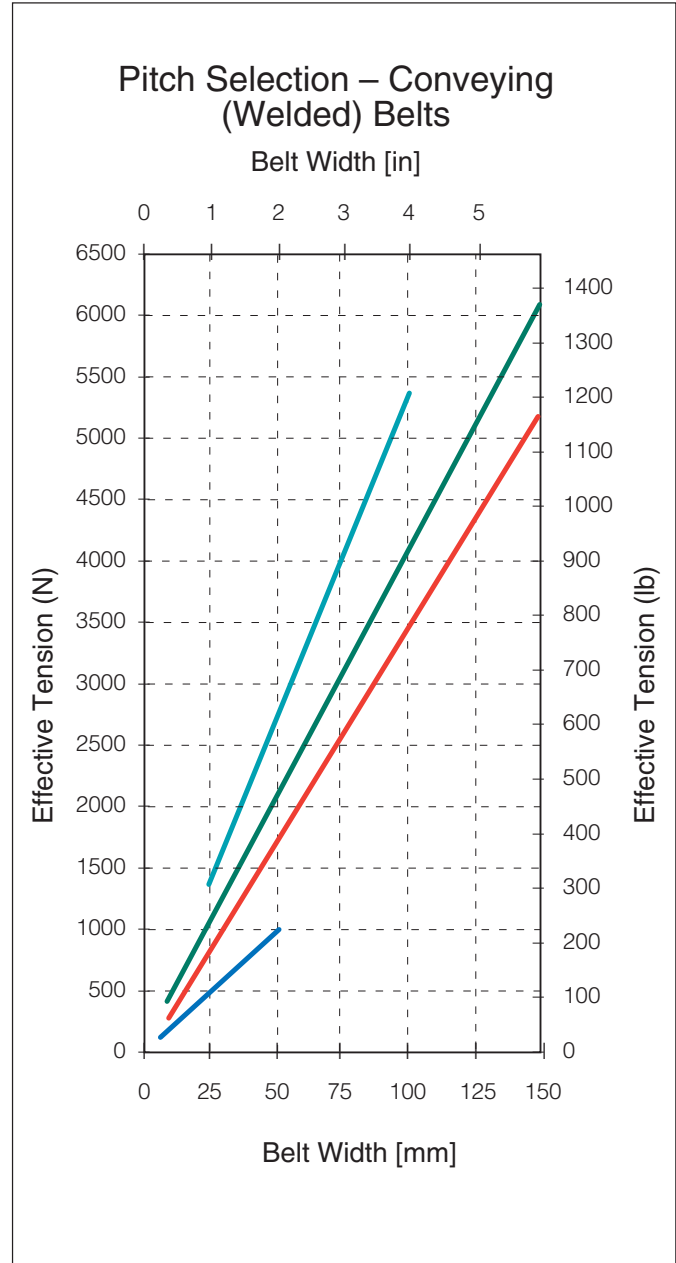
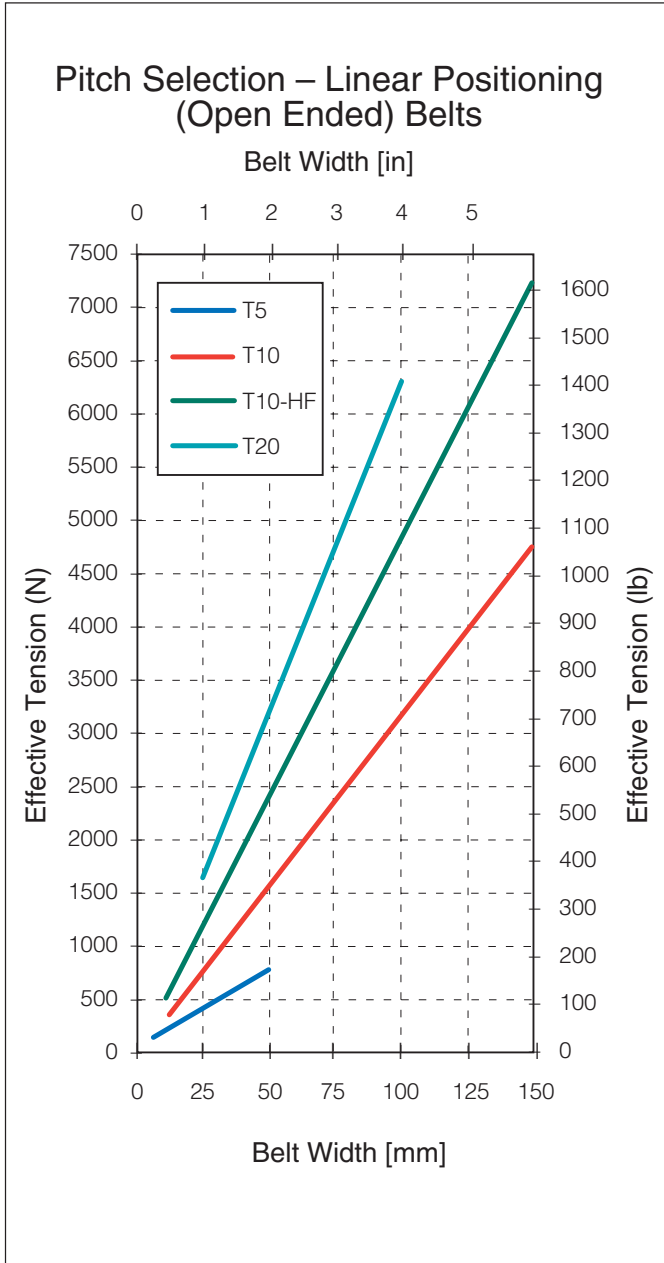

GRAPH 2b

Technical Design Tools

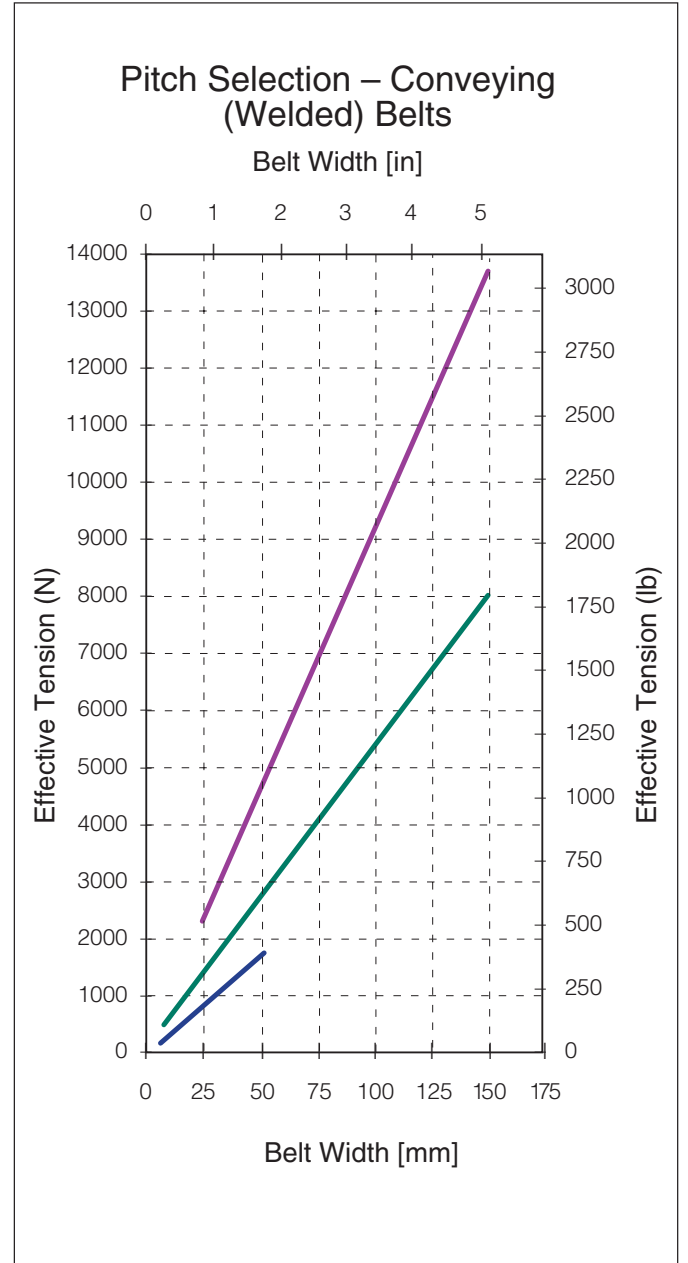
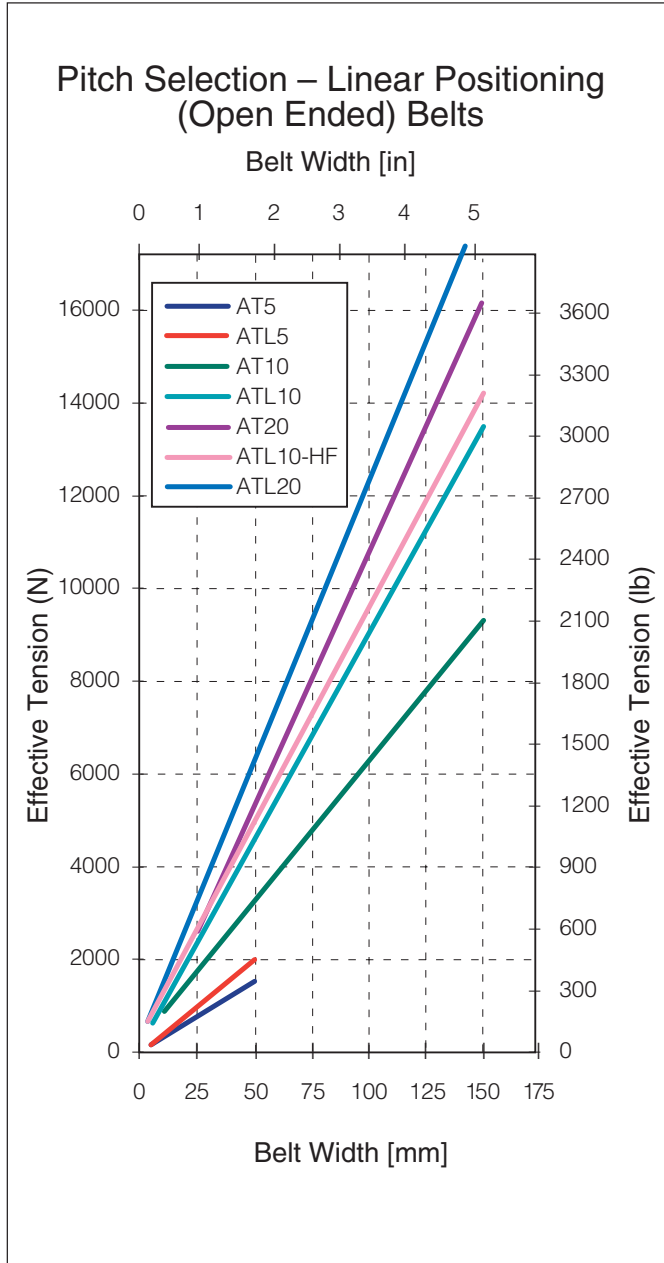

GRAPH 2c

Technical Design Tools

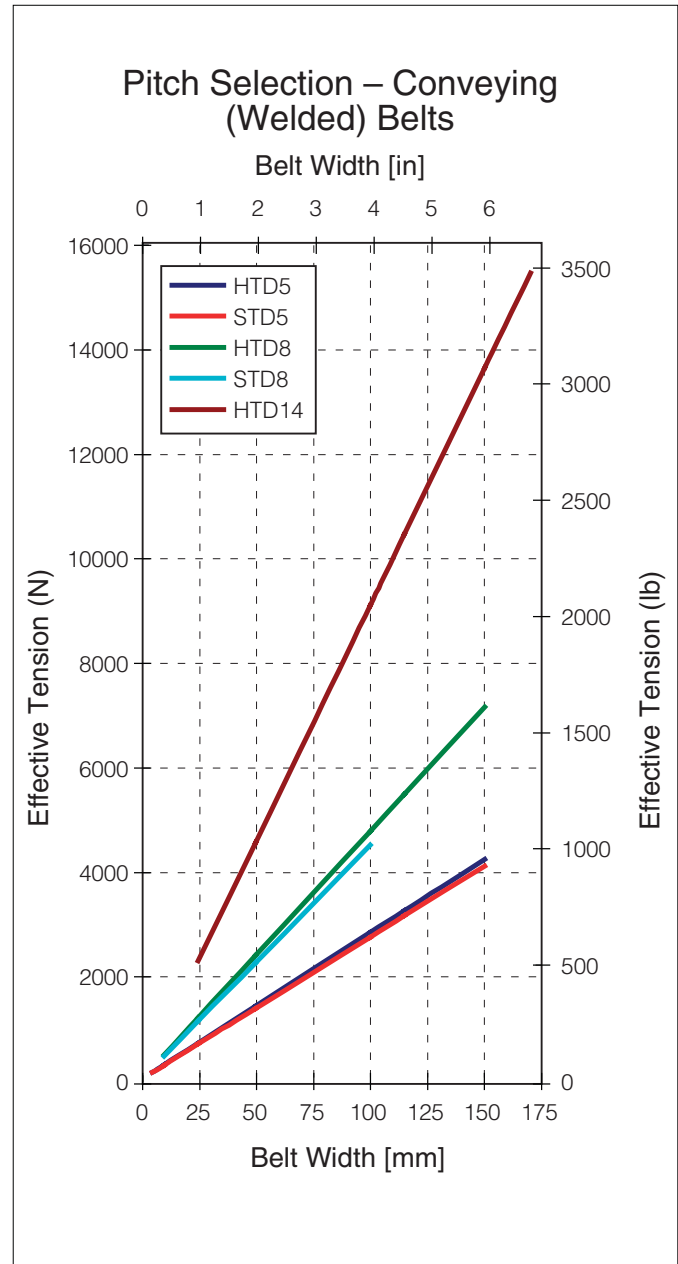
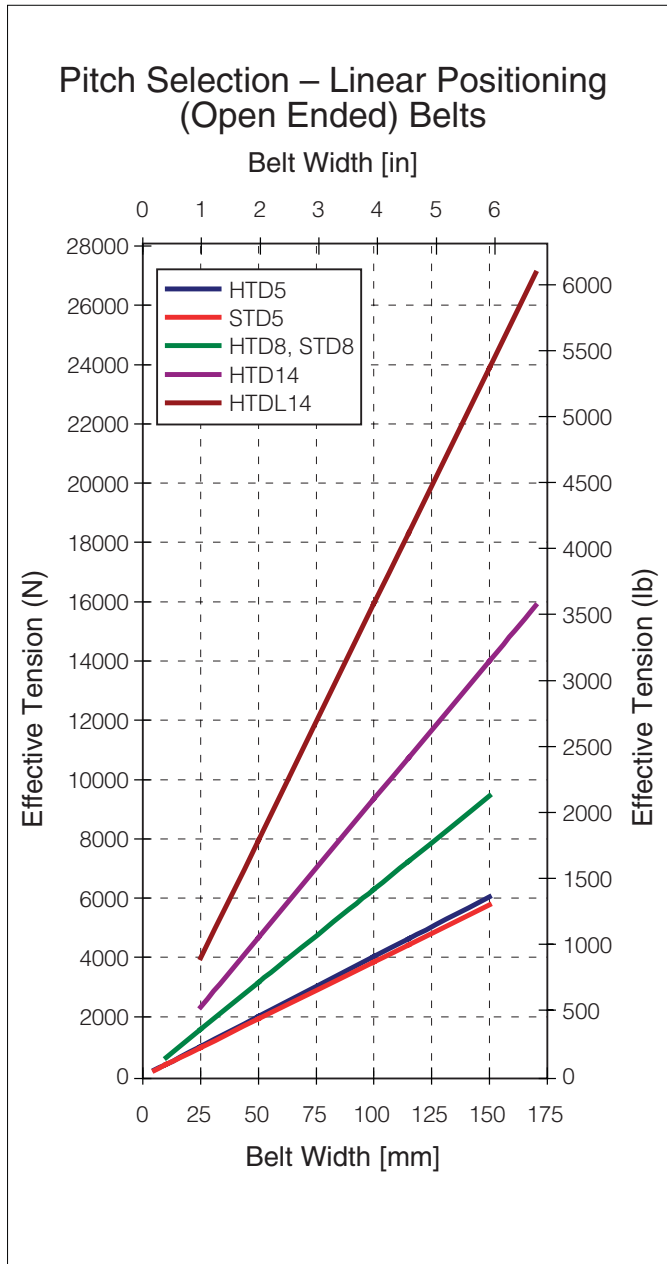

GRAPH 2d

Belt Sizing Examples

Conveying

$v = 120$ ft/min	Speed
$W = 60$ lb	Box weight
18" x 12"	Box bottom size
$C = 28$ ft (336 in)	Center distance
$b = 15^\circ$	Conveyor angle of incline
$d_o \approx 3.5$ "	Pulley outside diameter
slider bed made of steel	
belt teeth covered with nylon fabric	

Considering only the box size, a belt width of approximately 12" would be necessary. Instead of using one 12" wide belt, however, we decide to build a conveyor with two parallel running belts. The minimum belt width will be determined.

Step 1

The boxes are carried lengthwise on 2 ft centers
Weight distribution over conveyor length $w_m = 30$ lb/ft.

Friction force

$$F_f = \mu \cdot w_m \cdot L_m \cdot \cos\beta$$

$$F_f = 0.3 \cdot 30 \frac{\text{lb}}{\text{ft}} \cdot 28 \text{ ft} \cdot \cos 15^\circ \quad F_f = 243.4 \text{ lb}$$

(coefficient of friction $\mu = 0.3$ obtained from Table 1A)

Gravitational load

$$F_g = w_m \cdot L_m \cdot \sin\beta$$

$$F_g = 30 \frac{\text{lb}}{\text{ft}} \cdot 28 \text{ ft} \cdot \sin 15^\circ \quad F_g = 217.4 \text{ lb}$$

Effective tension

$$T_e = 243.4 \text{ lb} + 217.4 \text{ lb} \quad T_e = F_f + F_g$$

$$T_e = 460.8 \text{ lb}$$

Step 2

Selected belt tooth profile =>H (Graph 2a)

An effective tension of 460.8 lb can be transmitted by either L or H belt. We choose H tooth profile (0.5"). The minimum belt width to transmit the load will be approximately 2.5 inches.

Step 3

Approximate number of pulley teeth

$$\bar{z}_p = \frac{\pi \cdot \bar{d}}{p}$$

$$\bar{z}_p = \frac{\pi \cdot 3.5 \text{ in}}{0.5 \text{ in}} = \bar{z}_p = 21.99$$

Chosen number of teeth

$$z = 22$$

(chosen number of teeth is greater than the recommended minimum number of pulley teeth for H tooth profile belt [$z_{\min} = 14$] given in Table 1)

Pulley pitch diameter

$$d = \frac{p \cdot z_p}{\pi}$$

$$d = \frac{0.5 \text{ in} \cdot 22}{\pi} \quad d = 3.501 \text{ in}$$

Step 4

Preliminary number of belt teeth

$$\bar{z}_b = 2 \cdot \frac{\bar{C}}{p} + z_p$$

$$\bar{z}_b = 2 \cdot \frac{336 \text{ in}}{0.5 \text{ in}} + 22$$

$$\bar{z}_b = 1366$$

Chosen number of belt teeth

$$z_b = 1366$$

Belt length

$$L = z_p \cdot p$$

$$L = 1366 \cdot 0.5 \text{ in} \quad L = 683 \text{ in}$$

Step 5

Number of teeth in mesh

$$z_m = \frac{z_p}{2}$$

$$z_m = 11$$

Step 6

Pre-tension

$$T_i = 0.5 T_e$$

$$T_i = 0.5 \cdot 460.8 \text{ lb} \quad T_i = 230.4 \text{ lb}$$

Step 7

Tight side tension

$$T_1 \approx T_i + 0.75 T_e$$

$$T_1 \approx 230.4 \text{ lb} + 0.75 \cdot 460.8 \text{ lb} \quad T_1 = 576 \text{ lb}$$

Slack side tension

$$T_2 = 576 - 460.8 \text{ lb} \quad T_2 = 115.2 \text{ lb}$$

Step 8

Allowable belt tension (from Table 1)

$$T_{1\text{all}} = 245 \text{ lb/in}$$

Belt width b to withstand $T_{1\text{max}}$

$$b \geq \frac{T_{1\text{max}}}{T_{1\text{all}}}$$

$$b \geq \frac{576 \text{ lb}}{245 \frac{\text{lb}}{\text{in}}} \quad b \geq 2.35 \text{ in}$$

Allowable effective tension (from Table 1)

$$T_{e\text{all}} = 330 \text{ lb/in}$$

Tooth in mesh factor (from Table 3; for $z_m = 11$)

$$t_m = 0.92$$

Speed factor (from Table 4; for $v = 120$ ft/min)

$$t_v = 1$$

Belt width to transmit T_e

$$b \geq \frac{T_e}{T_{e\text{all}} \cdot t_m \cdot t_v}$$

$$b \geq \frac{460.8 \text{ lb}}{330 \frac{\text{lb}}{\text{in}} \cdot 0.92 \cdot 1} \quad b \geq 1.52 \text{ in}$$

Chosen belt width—boxes will be conveyed on two belts 1.5" wide each

(Note that each belt is loaded by half of the calculated forces)

Belt Sizing Examples

Step 9

Shaft force at driver

$$F_{s1} = T_1 + T_2$$

$$F_{s1} = 576 \text{ lb} + 115.2 \text{ lb}$$

$$F_{s1} = 691.2 \text{ lb}$$

Shaft force at idler

$$F_{s2} = 2T_2$$

$$F_{s2} = 2 \cdot 115.2 \text{ lb}$$

$$F_{s2} = 230.4 \text{ lb}$$

Linear Positioning

$$v = 3.5 \text{ m/s}$$

$$a = 20 \text{ m/s}^2$$

$$m_s = 30 \text{ kg}$$

$$F_f = 50 \text{ N}$$

$$\Delta_x \leq 0.1 \text{ mm}$$

$$d_o \approx 50 \text{ mm}$$

$$C = 3000 \text{ mm}$$

$$S = 2500 \text{ mm}$$

$$L_p = 160 \text{ mm}$$

Speed

Slide acceleration

Slide mass

Friction force

Positioning error

Pulley diameter

Center distance

Travel

Platform length

Step 1

Force to accelerate the slide

$$F_a = 30 \text{ kg} \cdot 20 \text{ m/s}^2$$

$$F_a = m_s \cdot a$$

$$F_a = 600 \text{ N}$$

Friction force

$$F_f = 50 \text{ N}$$

Effective tension

$$T_e = 600 \text{ N} + 50 \text{ N}$$

$$T_e = F_a + F_f$$

$$T_e = 650 \text{ N}$$

Step 2

Selected belt tooth form =>AT5 (Graph 2c)

For linear positioning, belts of the AT series are preferred, because of the higher cord and tooth stiffness.

Step 3

Approximate number of pulley teeth

$$\bar{z}_p = \frac{\pi \cdot 50 \text{ mm}}{5 \text{ mm}}$$

$$\bar{z}_p = \frac{\pi \cdot \bar{d}}{p}$$

$$\bar{z}_p = 31.4$$

Chosen number of teeth

$$z_p = 32$$

(greater than the recommended minimum number of pulley teeth for an AT5 belt [$z_{\min} = 12$] given in Table 1)

Pulley pitch diameter

$$d = \frac{5 \text{ mm} \cdot 32}{\pi}$$

$$d = \frac{p \cdot z_p}{\pi}$$

$$d = 50.93 \text{ mm}$$

Step 4

Preliminary number of belt teeth

$$\bar{z}_b = \frac{2 \cdot 3000 \text{ mm}}{5 \text{ mm}} + 32$$

$$\bar{z}_b = 2 \cdot \frac{\bar{C}}{p} + z_p$$

$$\bar{z}_b = 1232$$

Chosen number of belt teeth

$$z = 1232$$

Belt length

$$L = 1232 \cdot 5 \text{ mm}$$

$$L = z_b \cdot p$$

$$L = 6160 \text{ mm}$$

(incl. 160mm over the slide)

Step 5

Number of teeth in mesh

$$z_m = \frac{32}{2}$$

$$z_m = \frac{z_p}{2}$$

$$z_m = 16$$

Step 6

Belt pre-tension

$$T_i = 1.1 \cdot 650 \text{ N}$$

$$T_i = 1.1 \cdot T_e$$

$$T_i = 715 \text{ N}$$

Step 7

Maximum tight side tension

$$T_{1\max} \approx 715 \text{ N} + 650 \text{ N}$$

$$T_{1\max} \approx T_i + T_e$$

$$T_{1\max} = 1365 \text{ N}$$

Maximum slack side tension

$$T_{2\max} \approx 1365 \text{ N} - 650 \text{ N}$$

$$T_{2\max} \approx T_{1\max} - T_e$$

$$T_{2\max} = 715 \text{ N}$$

Step 8

Allowable belt tension (from Table 1)

$$T_{1\text{all}} = 1615 \text{ N}/25 \text{ mm}$$

Belt width b to withstand $T_{1\max}$

$$b \geq \frac{1365 \text{ N}}{1615 \text{ N}} \cdot 25 \text{ mm}$$

$$b \geq \frac{T_{1\max}}{T_{1\text{all}}}$$

$$b \geq 21.1 \text{ mm}$$

Allowable effective tension (from Table 1)

$$T_{e\text{all}} = 1270 \text{ N}/25 \text{ mm}$$

Tooth in mesh factor (from Table 3; for $z_m = 16$)

$$t_m = 1$$

Speed factor

(from Table 4; for $v = 3.5 \text{ m/s}$)

$$t_v = 0.96$$

Belt width to transmit T_e

$$b \geq \frac{650 \text{ N}}{\frac{1270 \text{ N}}{25 \text{ mm}} \cdot 1 \cdot 0.96}$$

$$b \geq \frac{T_e}{T_{e\text{all}} \cdot t_m \cdot t_v}$$

$$b \geq 13.3 \text{ mm}$$

Chosen belt width (for increased stiffness a wider belt is chosen) $b = 50 \text{ mm}$

Step 9

Maximum shaft force at driver

$$F_{s1\max} = 1365 \text{ N} + 715 \text{ N}$$

$$F_{s1\max} = T_{1\max} + T_{2\max}$$

$$F_{s1\max} = 2080 \text{ N}$$

Maximum shaft force at idler

$$F_{s2\max} = 2 \cdot 1365 \text{ N}$$

$$F_{s2\max} = 2 \cdot T_{1\max}$$

$$F_{s2\max} = 2730 \text{ N}$$

Step 10

Belt stiffness

$$k = 17600 \cdot \frac{\text{N}}{\text{mm}} \cdot 50 \text{ mm} \cdot \frac{6000 \text{ mm}}{3290 \text{ mm} \cdot 2710 \text{ mm}}$$

$$k = c_{sp} \cdot b \cdot \frac{L_1 + L_2}{L_1 \cdot L_2}$$

$$k = 592.2 \frac{\text{N}}{\text{mm}}$$

Slide displacement

$$\Delta x = \frac{50 \text{ N}}{592.2 \frac{\text{N}}{\text{mm}}}$$

$$\Delta x = \frac{F_{st}}{k}$$

$$\Delta x = 0.084 \text{ mm} < 0.1 \text{ mm}$$

Static load on the slide F_{st} is equal to the friction force ($F_{st} = F_f = 50 \text{ N}$)



GATES MECTROL, INC.

9 Northwestern Drive
Salem, NH 03079, U.S.A.

Tel. +1 (603) 890-1515

Tel. +1 (800) 394-4844

Fax +1 (603) 890-1616

email: apps@gatesmectrol.com

Gates Mectrol is a registered trademark of Gates Mectrol Incorporated. All other trademarks used herein are the property of their respective owners.

© Copyright 2006 Gates Mectrol Incorporated. All rights reserved. 10/06

GM_Belt Sizing Guide_06_US