



# TPU BELTS

THERMOPLASTIC POLYURETHANE

SYNCHRO-POWER™

# GPP BELT

DESIGNED FOR HIGH SPEED AND HIGH LOAD

# GATES PARABOLIC PROFILE (GPP) HIGH STRENGTH AND LOW NOISE

Our Synchro-Power GPP belts are high performance, top quality belts designed for high speed precision accuracy to improve your operating efficiency.

Standard GPP belts utilise strong steel reinforcement cord to deliver full tensile strength and allow very small pulley diameters. Reinforced RSL belts have very high tensile strength and stiffness for highly dynamic positioning and vertical lifting applications.

A wear-resistant nylon fabric on the tooth side allows Synchro-Power GPP belts to operate smoothly with high abrasion resistance.

Gates Synchro-Power GPP belts are high-performance, precision-engineered thermoplastic polyurethane (TPU) synchronous belts designed for demanding linear motion, transport, and lifting applications.

HF versions are built with highly flexible steel cords, they support small pulley diameters while delivering excellent tensile strength. RSL versions offer enhanced stiffness and strength for high-load, dynamic positioning and vertical movement. A wear-resistant nylon tooth fabric ensures low noise and high abrasion resistance.

Available in standard and low-temperature urethanes, GPP belts operate reliably in a wide range of environments, including deep freeze and outdoor conditions. Compatible with RPP\*, HTD, and HTD SG pulleys, Gates Synchro-Power GPP belts offer exceptional durability, reduced downtime, and consistent performance, making them the top choice for thermoplastic polyurethane synchronous belt solutions.

## FEATURES + BENEFITS

- GPP8 or GPP14 pitch
- RPP\* or HTD pulleys
- Standard belts for medium load capacity
- Reinforced RSL belts for high load applications
- Standard tooth side Nylon fabric
- Optional back side Nylon fabric
- GPP8 in widths up to 150 mm (5.91")
- GPP14 in widths up to 200 mm (7.87")
- Small pulley diameters

\* RPP is a trademark of The Timken Company

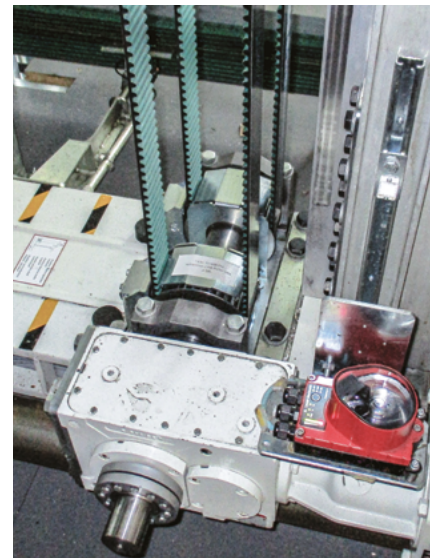
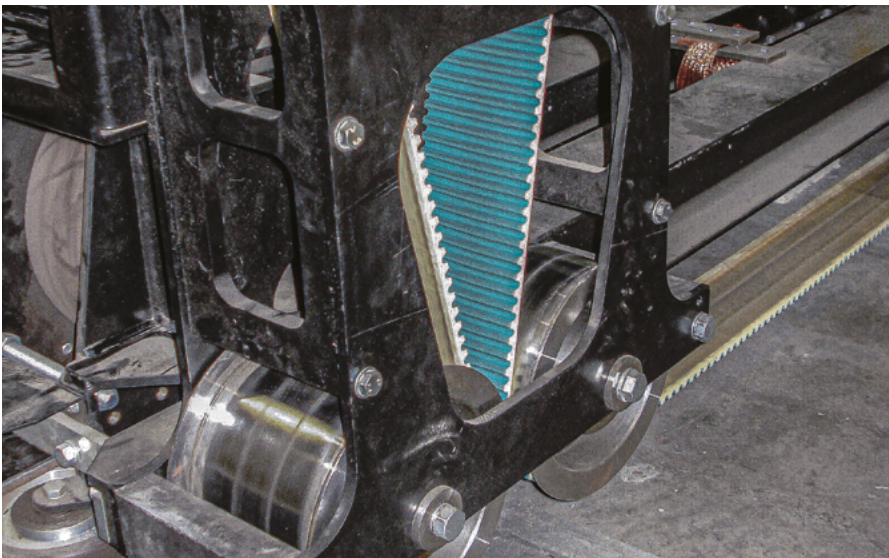

## SYNCHRO-POWER GPP8

Our basic 8M pitch parabolic profile belt is ideal for light and medium linear actuation applications, door opening systems, and any application requiring an endless welded belt system for transportation.

- Highly flexible steel cord construction is designed for very small pulley diameters
- Optional stainless steel cord construction for highly corrosive environments
- Durable and abrasion resistant standard 92 Shore A urethane for -5 to +70°C (+23 to +158°F) temperatures
- Optional low temp urethane for low temperature applications – deep freeze warehousing or outdoor equipment
- Nylon fabric tooth side for low friction and low noise – optional Nylon fabric back side
- GPP8 belt runs in RPP8\* as well HTD8M pulleys



## SYNCHRO-POWER GPP8-RSL

In the same dimensions of the GPP8, our RSL belt is equipped with high strength steel cord. A GPP8-RHF belt is available for small pulley diameters.

- Higher tensile strength and higher stiffness is perfect for high-precision and very dynamic light to middle load linear applications as well as medium weight lifting
- Standard Applications: RPP8\* or HTD8M pulleys
- High Load Applications: HTD8M SG (shallow groove) pulleys recommended for perfect fit and longer life
- Standard version for -5 to +70°C (+23 to +158°F) temperatures (low temp version for -30 to +50°C (-22 to +122°F))
- Nylon fabric tooth side for low friction and low noise – optional Nylon fabric back side

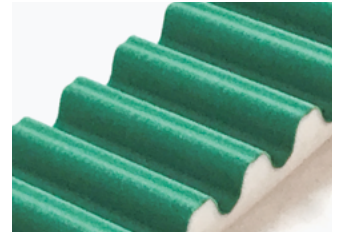

## SYNCHRO-POWER GPP14

Using a special cord construction, our basic 14M pitch parabolic profile belt delivers great tensile strength and extremely high stiffness for less elastic elongation.

- GPP14 belt runs in RPP14\* or HTD14M pulleys
- High Load Applications: HTD14M SG (shallow groove) pulleys recommended for perfect fit and longer life
- Standard version for -5 to +70°C (+23 to +158°F) temperatures (low temp version for -30 to +50°C (-22 to +122°F))
- Nylon fabric tooth side for low friction and low noise – optional Nylon fabric on tooth and back side

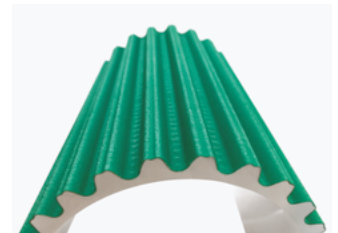

## SYNCHRO-POWER GPP14-RSL

Extremely high strength makes our GPP14-RSL belt perfect for heavy lifting and highly dynamic linear movement applications such as high load stacker cranes in automated warehouses – including deep freeze – and material elevators in the automotive industry.

- High Load Applications: Use HTD14M SG (shallow groove) pulleys for perfect fit and longer life
- Standard version for -5 to +70°C (+23 to +158°F) temperatures (low temp version for -30 to +50°C (-22 to +122°F))
- Nylon fabric tooth side for low friction and low noise – optional Nylon fabric on tooth and back side

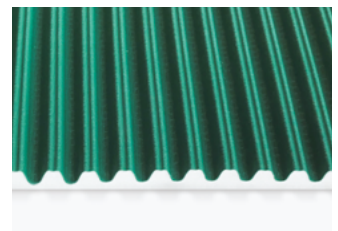

\* RPP is a trademark of The Timken Company

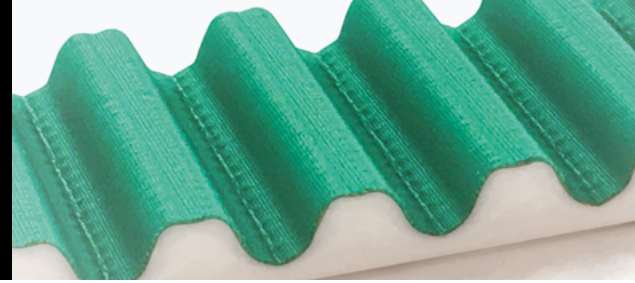

**PRODUCT SPECIFICATIONS**

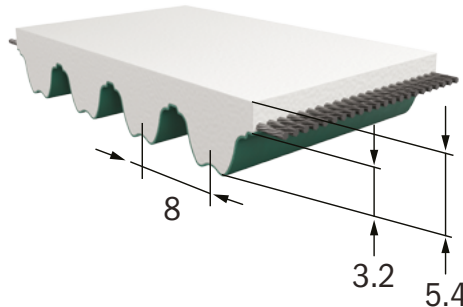
<b>PITCH</b>	8 mm	0.32"
<b>STANDARD THICKNESS</b>	5.4 mm	0.21"
<b>WIDTH TOLERANCE</b>	±0.50 mm	±0.020"
<b>MINIMUM WELDED BELT LENGTH</b>	960 mm	37.8"
<b>STANDARD ROLL LENGTH (TOLERANCE ±1%)</b>	100 m	328'
<b>STANDARD COLOR</b>	White	
<b>FDA/EU APPROVAL</b>	No	
<b>POLYAMIDE FABRIC</b>		
STANDARD	NT	
OPTIONAL	NTB	

**GPP8**

PITCH	POLYURETHANE	HARDNESS [·SHORE A]	TEMPERATURE RANGE		FEATURE
			·C	·F	
STANDARD	R1	92	-5 to +70	+23 to +158	Standard
OPTIONAL	R23T	90	-30 to +50	-22 to +122	Low Temperature

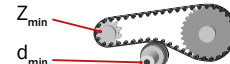
**MIN PULLEY TOOTH COUNT AND DIAMETER**

			STEEL (SL)		STEEL (HF)		STAINLESS (NIRO)	
No back bending		z min	18 teeth		16 teeth		25 teeth	
		d min	46 mm	1.81"	41 mm	1.61"	64 mm	2.52"
Back bending		z min	20 teeth		18 teeth		30 teeth	
		d min	120 mm	4.72"	100 mm	3.94"	150 mm	5.91"

**PULLEY DEFINITION**

GPP8 belt runs in RPP8\* and HTD8M pulley profile.

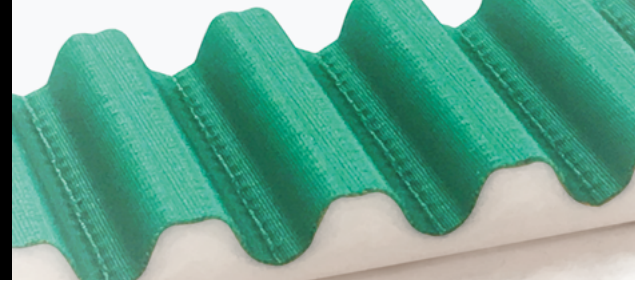

### TECHNICAL DATA

STANDARD WIDTH (mm)		10	15	20	25	30	50	85	100	150
<b>Breaking Force (Average Value)</b>										
Steel (SL)	[N]	5,700	8,550	12,350	15,200	19,000	32,300	56,050	66,500	98,800
	[lbf]	1,280	1,920	2,775	3,415	4,270	7,260	12,600	14,950	22,210
STEEL (HF)	[N]	5,190	7,785	11,245	13,840	17,300	29,410	51,035	60,550	89,960
	[lbf]	1,165	1,750	2,530	3,110	3,890	6,610	11,475	13,615	20,225
Stainless (NIRO)	[N]	4,275	6,413	9,263	11,400	14,250	24,225	42,038	49,875	74,100
	[lbf]	960	1,440	2,080	2,565	3,205	5,445	9,450	11,215	16,660
<b>Allowable Belt Force (Open Ended)</b>										
Steel (SL)	[N]	1,403	2,104	3,040	3,741	4,676	7,950	13,795	16,367	24,317
	[lbf]	315	473	683	841	1,051	1,787	3,101	3,680	5,467
STEEL (HF)	[N]	1,296	1,944	2,808	3,456	4,320	7,344	12,744	15,120	22,464
	[lbf]	291	437	631	777	971	1,651	2,865	3,399	5,050
Stainless (NIRO)	[N]	1,052	1,578	2,280	2,806	3,507	5,962	10,346	12,275	18,237
	[lbf]	237	355	513	631	788	1,340	2,326	2,760	4,100
<b>Allowable Belt Force (Endless Welded)</b>										
Steel (SL)	[N]	701	1,052	1,520	1,871	2,338	3,975	6,897	8,183	12,158
	[lbf]	158	237	342	421	526	894	1,551	1,840	2,733
STEEL (HF)	[N]	648	972	1,404	1,728	2,160	3,672	6,372	7,560	11,232
	[lbf]	146	219	316	388	486	826	1,433	1,700	2,525
Stainless (NIRO)	[N]	526	798	1,140	1,403	1,754	2,981	5,173	6,138	9,119
	[lbf]	118	179	256	315	394	670	1,163	1,380	2,050
<b>Allowable Effective Force (Min. 12 teeth in mesh)</b>										
	[N]	920	1,380	1,840	2,300	2,760	4,600	7,820	9,200	13,800
	[lbf]	207	310	414	517	621	1,034	1,758	2,068	3,103
<b>Belt Weight</b>										
Steel (SL)	[kg/m]	0,05	0,08	0,10	0,13	0,15	0,25	0,42	0,50	0,75
	[lb/ft]	0,03	0,05	0,07	0,08	0,10	0,17	0,28	0,34	0,51
STEEL (HF)	[kg/m]	0,05	0,07	0,09	0,12	0,14	0,23	0,39	0,47	0,70
	[lb/ft]	0,03	0,05	0,06	0,08	0,09	0,16	0,26	0,32	0,47
Stainless (NIRO)	[kg/m]	0,05	0,07	0,10	0,12	0,15	0,25	0,42	0,50	0,74
	[lb/ft]	0,03	0,05	0,07	0,08	0,10	0,17	0,28	0,33	0,50
<b>Specific Belt Stiffness</b>										
Steel (SL)	[N]	350,719	526,078	759,891	935,250	1,169,063	1,987,406	3,448,734	4,091,719	6,079,125
	[lbf]	78,849	118,273	170,839	210,263	262,829	446,809	775,345	919,901	1,366,710
STEEL (HF)	[N]	324,000	486,000	702,000	864,000	1,080,000	1,836,000	3,186,000	3,780,000	5,616,000
	[lbf]	72,842	109,263	157,824	194,245	242,806	412,770	716,277	849,820	1,262,590
Stainless (NIRO)	[N]	263,039	394,559	569,918	701,438	876,797	1,490,555	2,586,551	3,068,789	4,559,344
	[lbf]	59,136	88,705	128,129	157,697	197,122	335,107	581,509	689,926	1,025,032

# Gates® TPU BELTS

## SYNCHRO-POWER GPP8-RSL



### PRODUCT SPECIFICATIONS

<b>PITCH</b>	8 mm	0.32"
<b>STANDARD THICKNESS</b>	5.4 mm	0.21"
<b>WIDTH TOLERANCE</b>	±0.50 mm	±0.020"
<b>STANDARD ROLL LENGTH (TOLERANCE ±1%)</b>	100 m	328'
<b>STANDARD COLOR</b>	White	
<b>FDA/EU APPROVAL</b>	No	
<b>POLYAMIDE FABRIC</b>		
STANDARD	NT	
OPTIONAL	NTB	

### GPP8-RSL

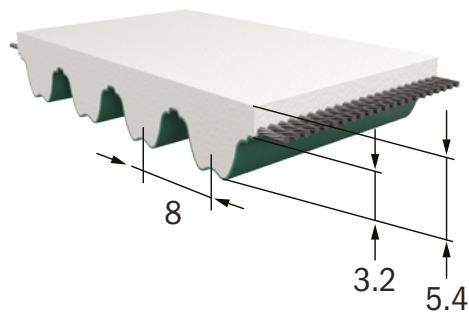

PITCH	POLYURETHANE	HARDNESS [·SHORE A]	TEMPERATURE RANGE		FEATURE
			·C	·F	
STANDARD	R1	92	-5 to +70	+23 to +158	Standard
OPTIONAL	R23T	90	-30 to +50	-22 to +122	Low Temperature

### MIN PULLEY TOOTH COUNT AND DIAMETER

		STEEL (RSL)		STEEL (RHF)		
No back bending		z min	31 teeth		25 teeth	
		d min	80 mm	3.15"	64 mm	2.52"
Back bending		z min	38 teeth		32 teeth	
		d min	150 mm	5.91"	130 mm	5.12"

### PULLEY DEFINITION

GPP8-RSL require special shallow groove pulleys. Please contact Gates TPU application engineering for more information.



# TPU BELTS

## SYNCHRO-POWER GPP8-RSL



### TECHNICAL DATA

STANDARD WIDTH (mm)		15	20	25	30	50	85	100	150
<b>Breaking Force (Average Value)</b>									
Steel (RSL)	[N]	13,840	19,030	25,950	31,140	51,900	91,690	103,800	155,700
	[lbf]	3,110	4,280	5,835	7,000	11,670	20,615	23,335	35,005
STEEL (RHF)	[N]	15,400	21,175	28,875	34,650	57,750	102,025	115,500	173,250
	[lbf]	3,460	4,760	6,490	7,790	12,985	22,935	25,965	38,950
<b>Allowable Belt Force (Open Ended)</b>									
Steel (RSL)	[N]	3,349	4,604	6,279	7,534	12,557	22,184	25,114	37,671
	[lbf]	753	1,035	1,412	1,694	2,823	4,987	5,646	8,469
STEEL (RHF)	[N]	2,902	3,991	5,442	6,530	10,884	19,228	21,767	32,651
	[lbf]	652	897	1,223	1,468	2,447	4,323	4,894	7,341
<b>Allowable Effective Force (Min. 12 teeth in mesh)</b>									
	[N]	1,380	1,840	2,300	2,760	4,600	7,820	9,200	13,800
	[lbf]	310	414	517	621	1,034	1,758	2,068	3,103
<b>Belt Weight</b>									
Steel (RSL)	[kg/m]	0.11	0.15	0.18	0.22	0.37	0.63	0.72	1.09
	[lb/ft]	0.07	0.10	0.12	0.15	0.25	0.42	0.49	0.73
STEEL (RHF)	[kg/m]	0.11	0.15	0.18	0.22	0.37	0.63	0.72	1.09
	[lb/ft]	0.07	0.10	0.12	0.15	0.25	0.42	0.49	0.73
<b>Specific Belt Stiffness</b>									
Steel (RSL)	[N]	837,143	1,151,071	1,569,643	1,883,571	3,139,286	5,546,071	6,278,571	9,417,857
	[lbf]	188,207	258,784	352,887	423,465	705,775	1,246,868	1,411,549	2,117,324
STEEL (RHF)	[N]	725,571	997,661	1,360,446	1,632,536	2,720,893	4,806,911	5,441,786	8,162,679
	[lbf]	163,123	224,294	305,856	367,027	611,712	1,080,690	1,223,423	1,835,135

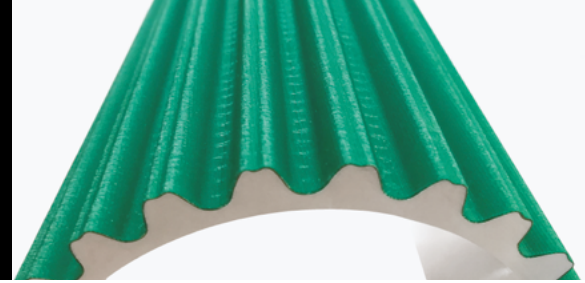

### PRODUCT SPECIFICATIONS

<b>PITCH</b>	14 mm	0.55"
<b>STANDARD THICKNESS</b>	9.7 mm	0.38"
<b>WIDTH TOLERANCE</b>	±1.0 mm	±0.04"
<b>MINIMUM WELDED BELT LENGTH</b>	NA	
<b>STANDARD ROLL LENGTH (TOLERANCE ±1%)</b>	50 m	164'
<b>STANDARD COLOR</b>	White	
<b>FDA/EU APPROVAL</b>	No	
<b>POLYAMIDE FABRIC</b>		
STANDARD	NT	
OPTIONAL	NTB	

### GPP14

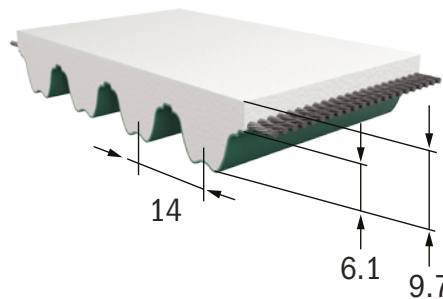

PITCH	POLYURETHANE	HARDNESS [·SHORE A]	TEMPERATURE RANGE		FEATURE
			°C	°F	
STANDARD	R1	92	-5 to +70	+23 to +158	Standard
OPTIONAL	R23T	90	-30 to +50	-22 to +122	Low Temperature

### MIN PULLEY TOOTH COUNT AND DIAMETER

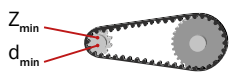
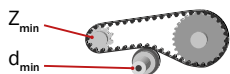
		STEEL (SL)	
No back bending		z min	32 teeth
		d min	140 mm    5.51"
Back bending		z min	32 teeth
		d min	200 mm    7.87"

### PULLEY DEFINITION

GPP14 belt runs in RPP14\* and HTD14M pulley profiles, for heavy lifting and high dynamic application please contact our application engineers.

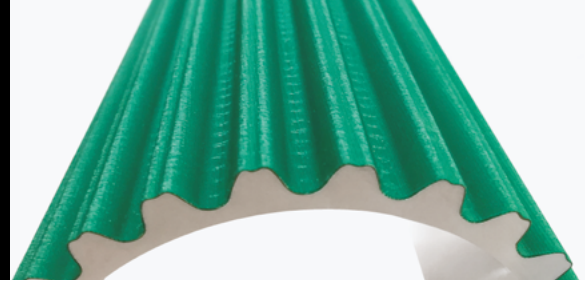

### TECHNICAL DATA

STANDARD WIDTH (mm)		40	55	85	115	150	170
<b>Breaking Force (Average Value)</b>							
Steel (SL)	[N]	64,600	87,400	136,800	186,200	247,000	273,600
	[lbf]	14,525	19,650	30,755	41,860	55,530	61,510
<b>Allowable Belt Force (Open Ended)</b>							
Steel (SL)	[N]	17,850	24,150	37,800	51,450	68,250	75,600
	[lbf]	4,013	5,429	8,498	11,567	15,344	16,996
<b>Allowable Effective Force (Min. 12 teeth in mesh)</b>							
	[N]	6,900	9,488	14,663	19,838	25,875	29,325
	[lbf]	1,551	2,133	3,297	4,460	5,817	6,593
<b>Belt Weight</b>							
Steel (SL)	[kg/m]	0.50	0.69	1.07	1.44	1.88	2.13
	[lb/ft]	0.34	0.46	0.72	0.97	1.26	1.43
<b>Specific Belt Stiffness</b>							
Steel (SL)	[N]	4,462,500	6,037,500	9,450,000	12,862,500	17,062,500	18,900,000
	[lbf]	1,003,260	1,357,352	2,124,550	2,891,749	3,835,994	4,249,101

# Gates® TPU BELTS

## SYNCHRO-POWER GPP14-RSL

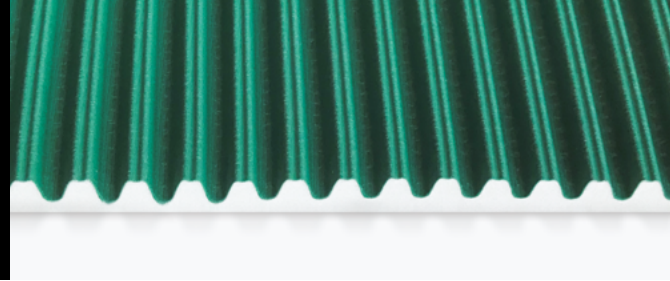

### PRODUCT SPECIFICATIONS

<b>PITCH</b>	14 mm	0.55"
<b>STANDARD THICKNESS</b>	9.7 mm	0.38"
<b>WIDTH TOLERANCE</b>	±1.0 mm	±0.04"
<b>MINIMUM WELDED BELT LENGTH</b>	NA	
<b>STANDARD ROLL LENGTH (TOLERANCE ±1%)</b>	50 m	164'
<b>STANDARD COLOR</b>	White	
<b>FDA/EU APPROVAL</b>	No	
<b>POLYAMIDE FABRIC</b>		
STANDARD	NT	
OPTIONAL	NTB	

### GPP14-RSL

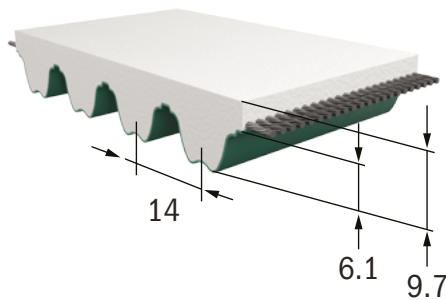

PITCH	POLYURETHANE	HARDNESS [·SHORE A]	TEMPERATURE RANGE		FEATURE
			·C	·F	
STANDARD	R1	92	-5 to +70	+23 to +158	Standard
OPTIONAL	R23T	90	-30 to +50	-22 to +122	Low Temperature

### MIN PULLEY TOOTH COUNT AND DIAMETER

		STEEL (RSL)	
No back bending		z min	34 teeth
		d min	152 mm    5.98"
Back bending		z min	34 teeth
		d min	250 mm    9.84"

### PULLEY DEFINITION

GPP14-RSL belt requires a special pulley profile, please contact our application engineers.



# TPU BELTS

## SYNCHRO-POWER GPP14-RSL

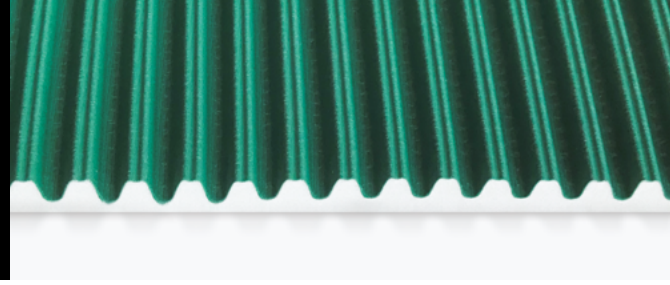

### TECHNICAL DATA

STANDARD WIDTH (mm)		40	55	85	115	150	200
<b>Breaking Force (Average Value)</b>							
Steel (RSL)	[N]	82,500	112,500	180,000	247,500	322,500	427,500
	[lbf]	18,550	25,290	40,470	55,645	72,505	96,110
<b>Allowable Belt Force (Open Ended)</b>							
Steel (RSL)	[N]	19,621	26,756	42,810	58,864	76,701	101,674
	[lbf]	4,411	6,015	9,625	13,234	17,244	22,858
<b>Allowable Effective Force (Min. 12 teeth in mesh)</b>							
	[N]	6,900	9,488	14,663	19,838	25,875	34,500
	[lbf]	1,551	2,133	3,297	4,460	5,817	7,756
<b>Belt Weight</b>							
Steel (RSL)	[kg/m]	0.56	0.76	1.18	1.60	2.08	2.78
	[lb/ft]	0.37	0.51	0.79	1.08	1.40	1.87
<b>Specific Belt Stiffness</b>							
Steel (RSL)	[N]	4,905,312	6,689,062	10,702,499	14,715,936	19,175,311	25,418,435
	[lbf]	1,102,813	1,503,836	2,406,137	3,308,439	4,310,996	5,714,576



# TPU BELTS

*THERMOPLASTIC POLYURETHANE*

Gates is a leading manufacturer of innovative thermoplastic polyurethane solutions, trusted worldwide for delivering superior quality, reliability, and optimal lead times.

**NORTH AMERICA**  
Gates TPU  
9 Northwestern Drive  
Salem, NH 03079  
Tel. +1 (800) 394-4844  
Email: SASales@gates.com

**GATES.COM**  
09/2025

